

Specification Guide

Groove Duet™ is a range of router-cut acoustic panels featuring a unique two-tone effect, offering endless style, color, and customization options. With 12 designs and the ability to mix and match shades from our color palettes, Groove Duet transforms walls into dynamic surfaces of depth, detail, and creative expression.



Groove Duet™



Path to Specification

1. Space

What are the dimensions of the space you are designing?

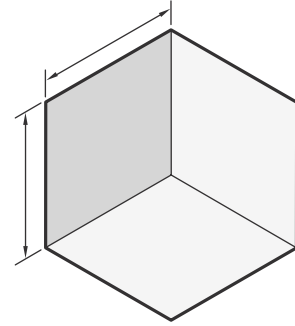

2. Size

What panel dimensions are available?

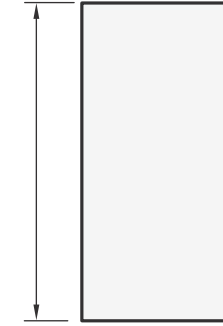

3. Style

What styles are available?

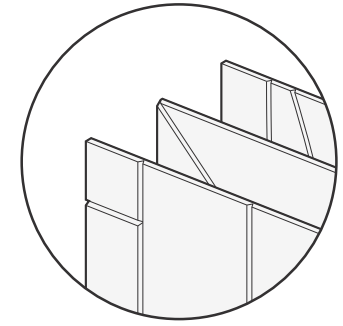

[Page 3](#)

[Page 4](#)

4. Layout

What orientations are possible?

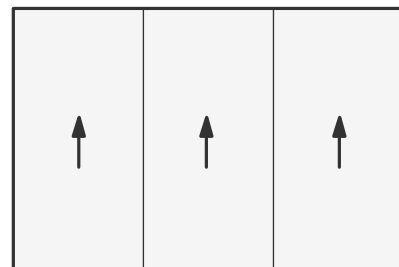

6. Detail Considerations

What install details should I consider?

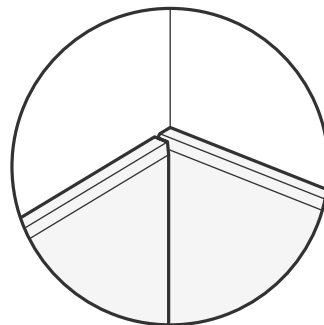

7. Colors and Finishes

What colors and finishes are available?

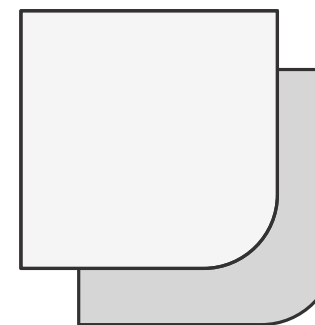

8. Technical Information

What are the technical specifications?

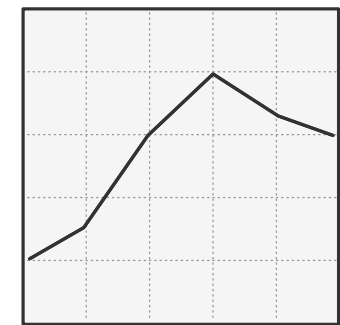

[Page 5-16](#)

[Page 17](#)

[Page 18-19](#)

[Page 22](#)



Standard Assembly



Panel Dimensions

Width	47 1/2" (1200mm)
Height	110" (2794mm) - standard
Thickness	3/8" (9mm), 1" (24mm)

Connection

Adhesive	Panels can be installed with appropriate adhesive (supplied by contractor)
Peel-and-Stick	Adhesive back supplied by Autex Acoustics®
SpinFix™	See SpinFix™ install guide See Product Installation Guide for further details

Colors and Finishes

Top Color	Available in all Vertiface® colors
Base Color	Available in all Cube™ colors
Finish	Velour finish option available

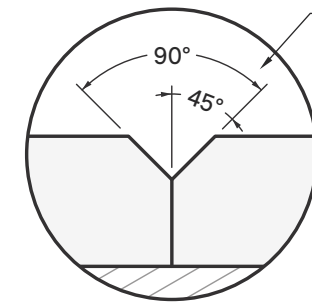
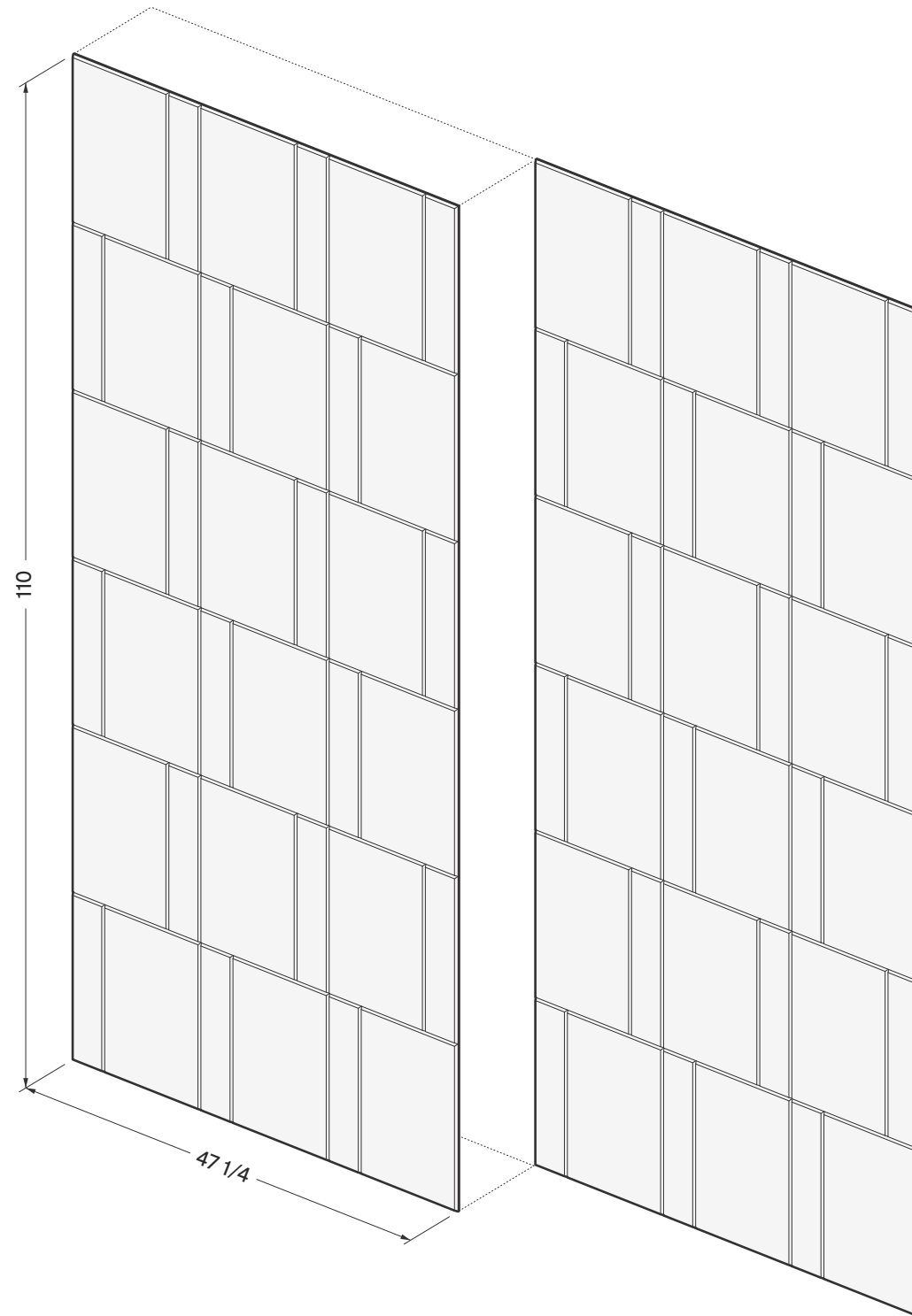

Unless otherwise specified, all Grooves will be 90 degrees.

Standard Groove Angle

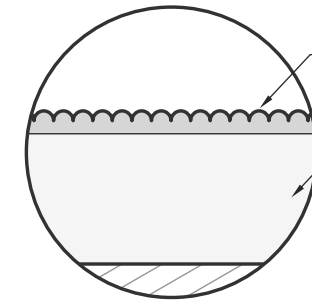

Vertiface Top Layer

Cube Base Layer

*Velour finish has pile direction

Velour Finish



Styles Overview



Stripe V1

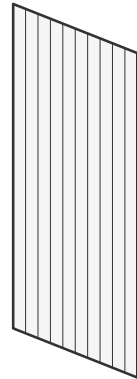

Oblique V2



Mesh V3



Gable V4

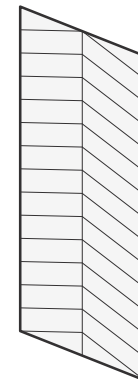

Radial V5

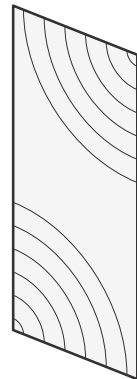

Bloc V6

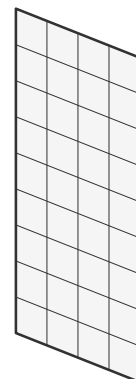

Bamboo V7

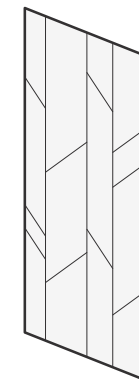

Facade V8

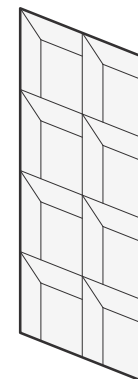

Whisp V9

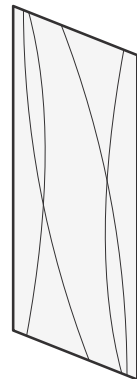

Arc V10

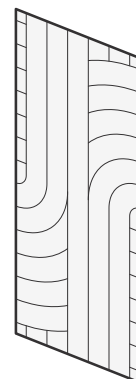

Refract V11

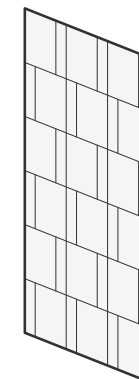

Nova V12

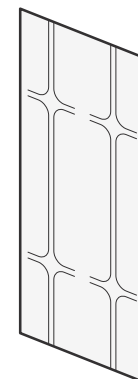

Style





Stripe V1



- Stripe style is equal divisions of vertical grooves across a panel
- The dimensions listed below are standard options, but can be changed if needed
- Unless specified otherwise, orders will be assumed to be all Panel A

Contact your Momentum account manager for further options.

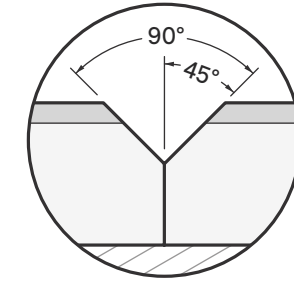

Panel side-edges are beveled with half of the specified groove angle for seamless panel joints

Panel A - Standard Centers

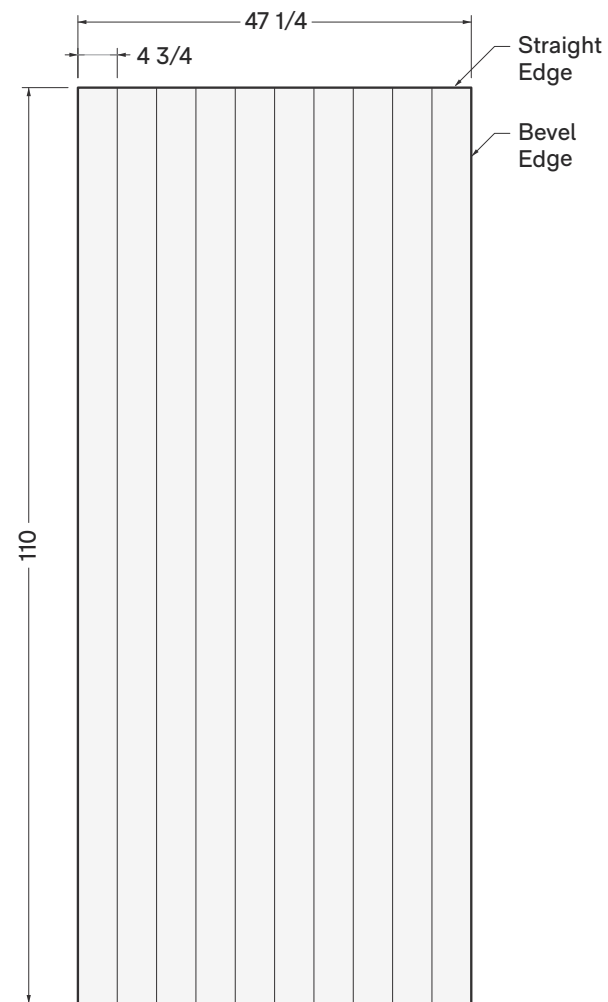

Panel B - Half Centers

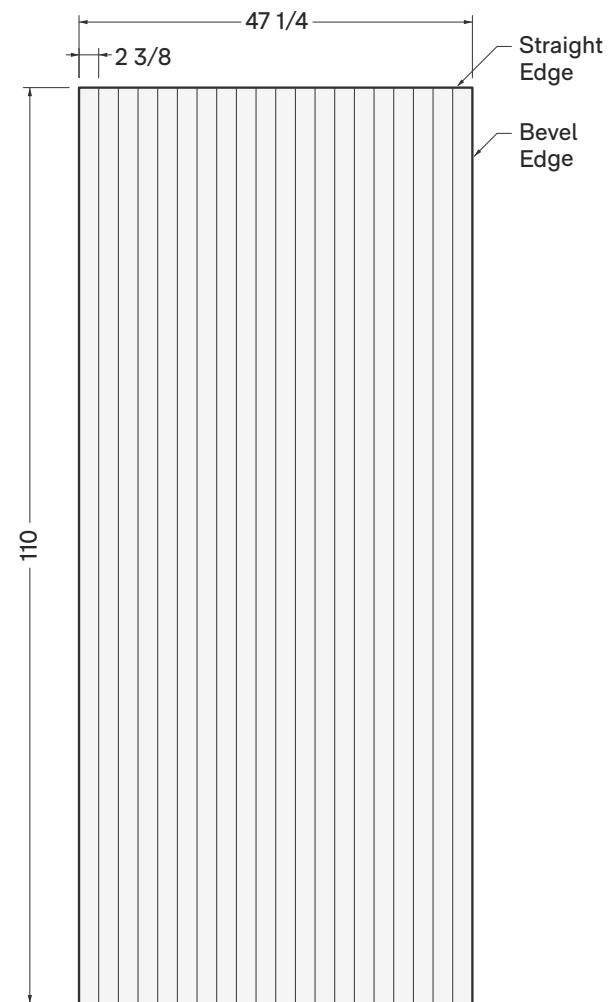

Panel C - Quarter Centers

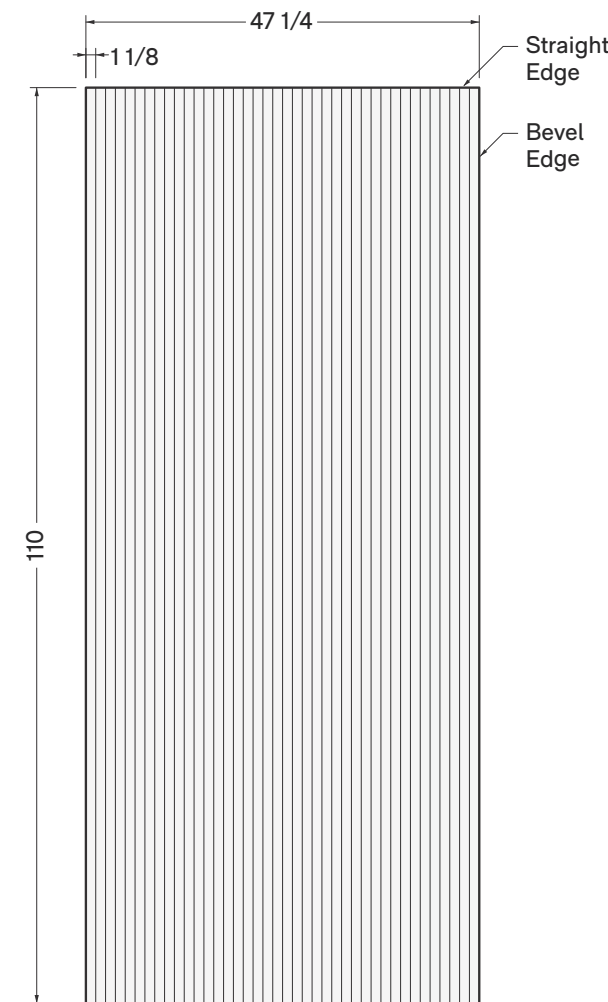

Layout Option

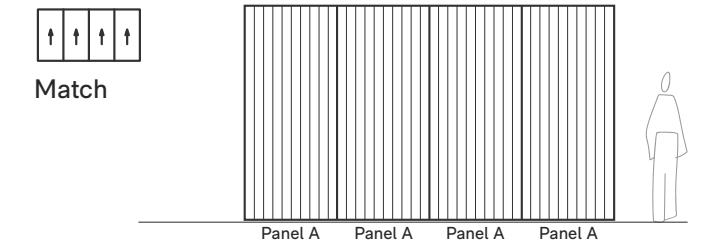

Panel measurements are in inches, and rounded to the nearest 1/8"



Oblique V2

- Oblique style is equal divisions of angle grooves across a panel
- The dimensions listed below are standard options, but can be changed if needed
- Unless specified otherwise, orders will be assumed to be all Panel A

Contact your Momentum account manager for further options.

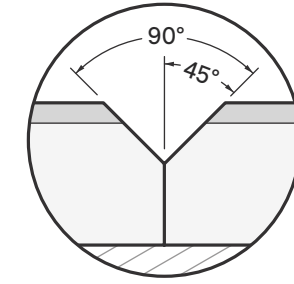

Panel side-edges are beveled with half of the specified groove angle for seamless panel joints

Panel A - Standard

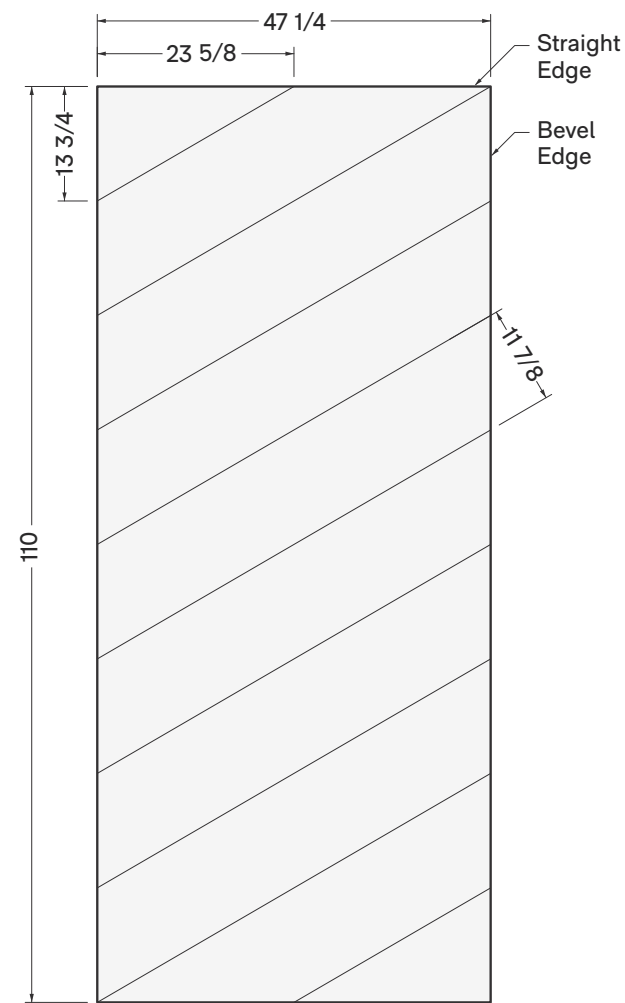

Panel B

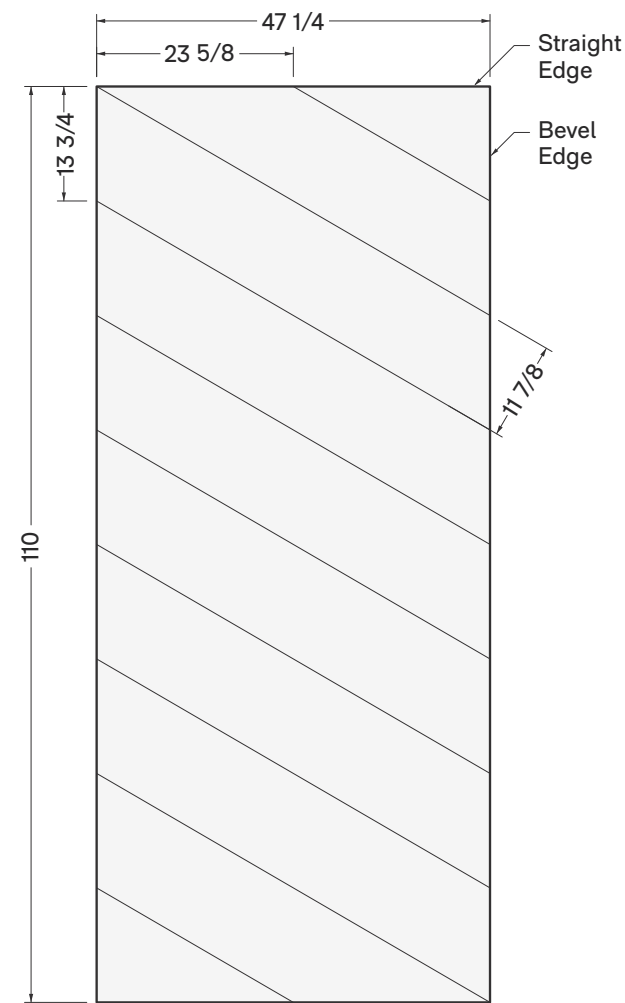

Layout Options

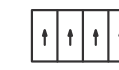

Match

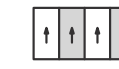
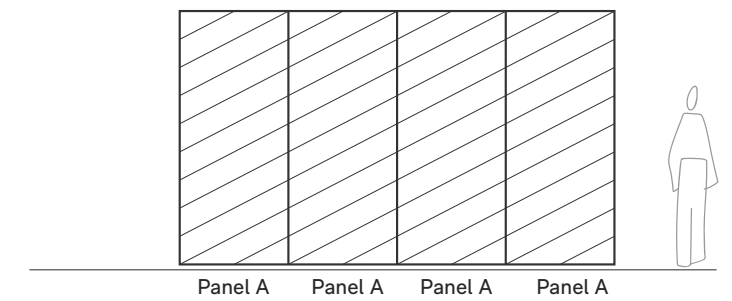

Alternate

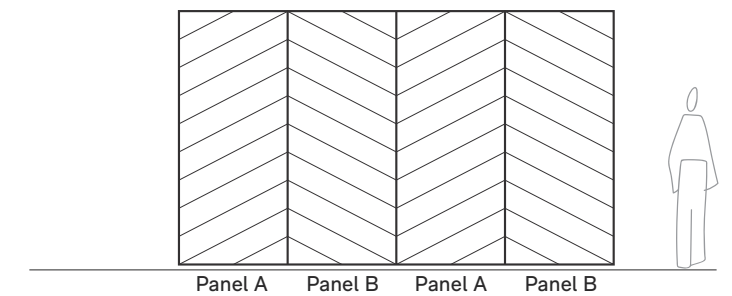

Panel measurements are in inches, and rounded to the nearest 1/8"



Mesh V3



- Mesh style is equal divisions of intersecting angled and vertical grooves across a panel
- The dimensions listed below are standard options, but can be changed if needed

Contact your Momentum account manager for further options.

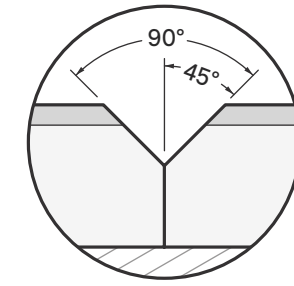

Panel side-edges are beveled with half of the specified groove angle for seamless panel joints

Panel A

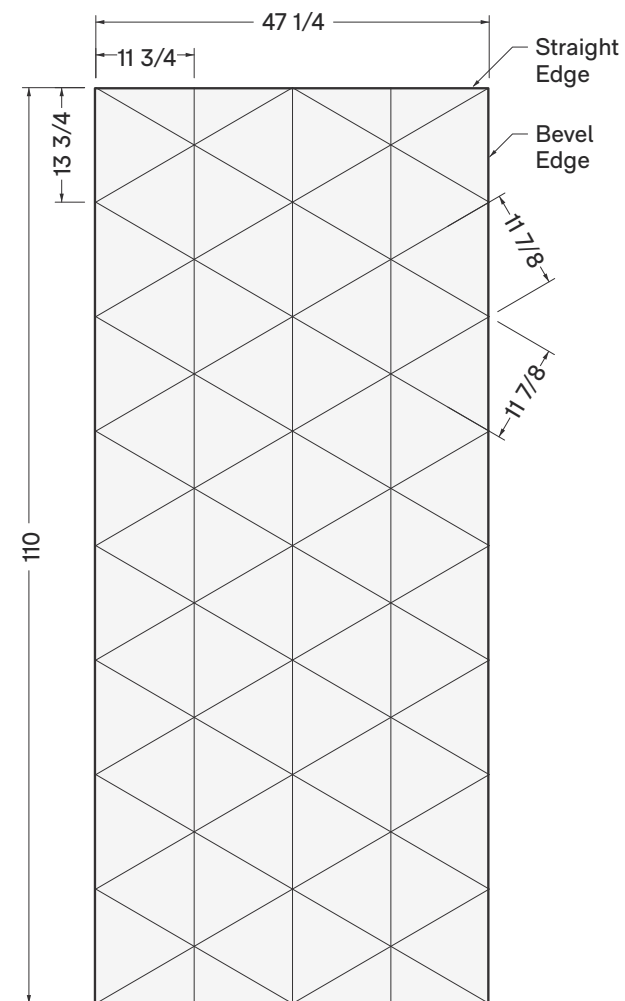

Layout Option

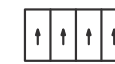

Match

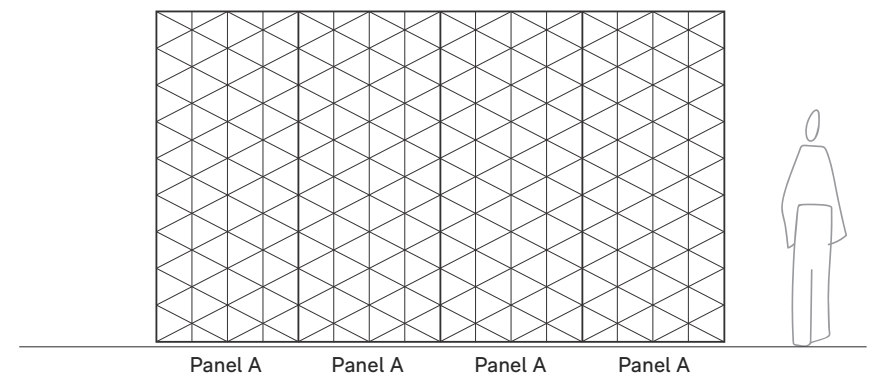

Panel measurements are in inches, and rounded to the nearest 1/8"



Gable V4



- Gable style is equal divisions of angled grooves, mirrored along the center of a panel
- The dimensions listed below are standard options, but can be changed if needed

Contact your Momentum account manager for further options.

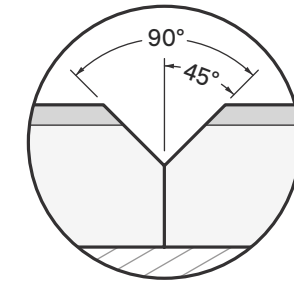

Panel side-edges are beveled with half of the specified groove angle for seamless panel joints

Panel A

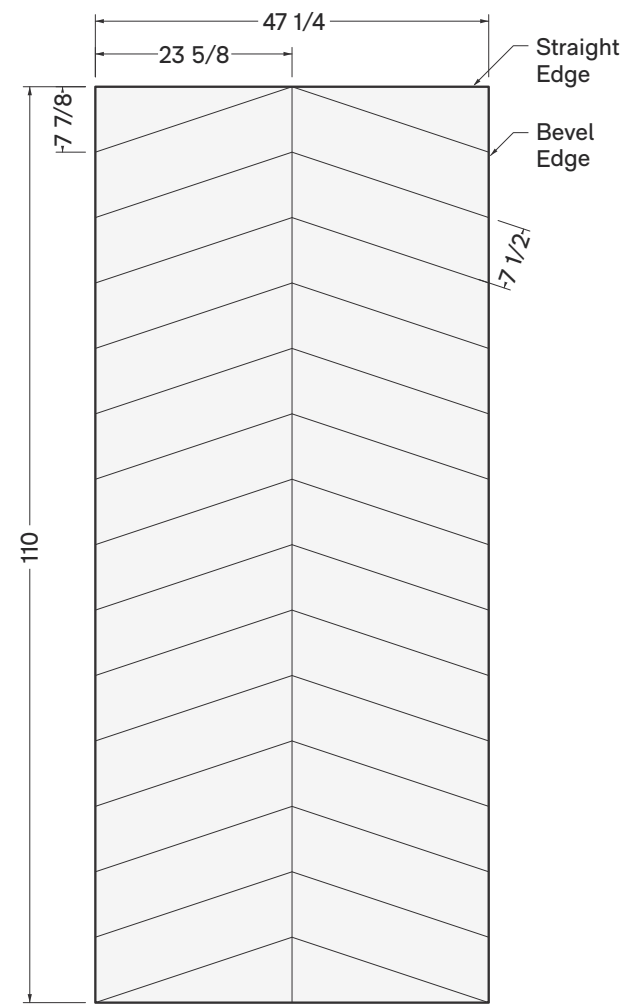

Layout Options

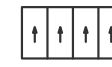

Match

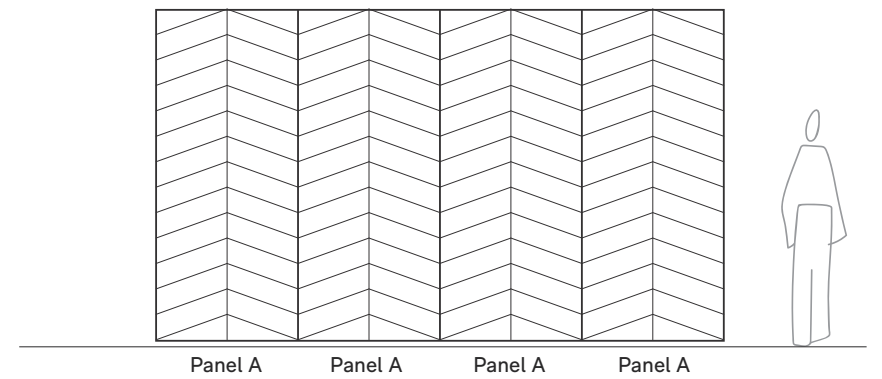

Panel measurements are in inches, and rounded to the nearest 1/8"



Radial V5

- Radial style is equal divisions of concentric grooves on opposite corners of a panel
- The dimensions listed below are standard options, but can be changed if needed
- Unless specified otherwise, orders will be assumed to be all Panel A

Contact your Momentum account manager for further options.

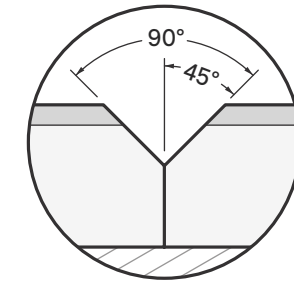

Panel side-edges are beveled with half of the specified groove angle for seamless panel joints

Panel A - Standard

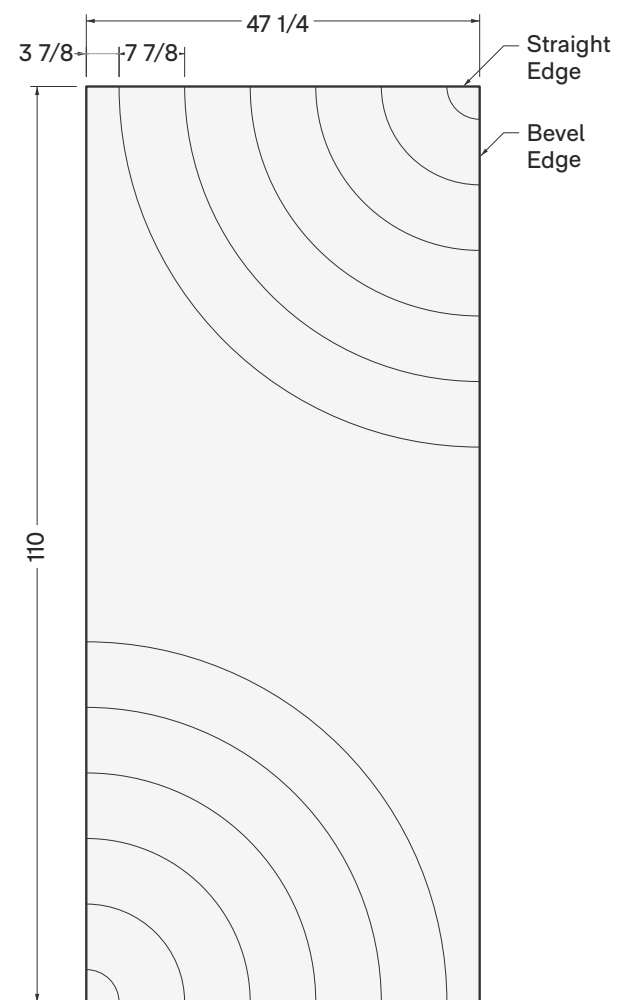

Panel B

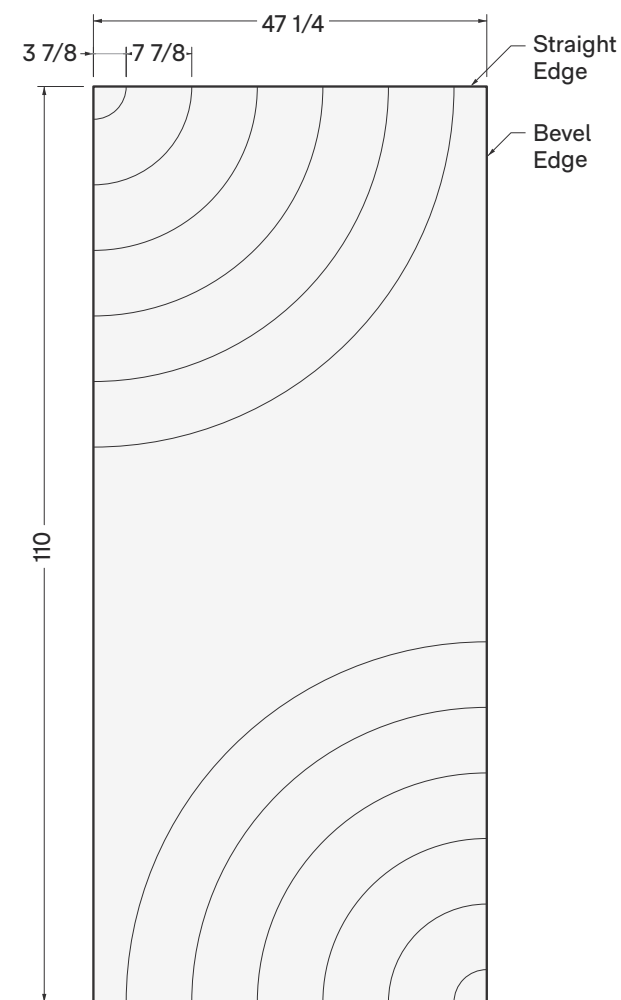

Layout Options

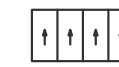

Match

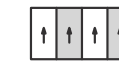
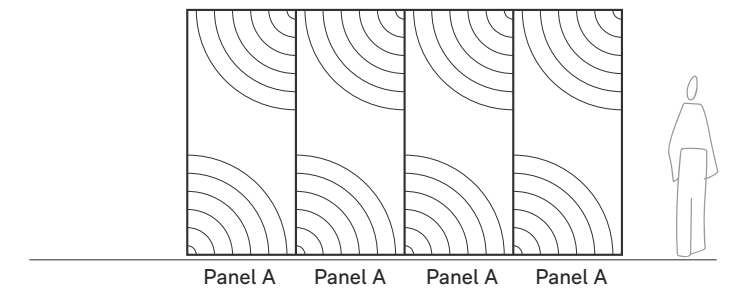

Alternate

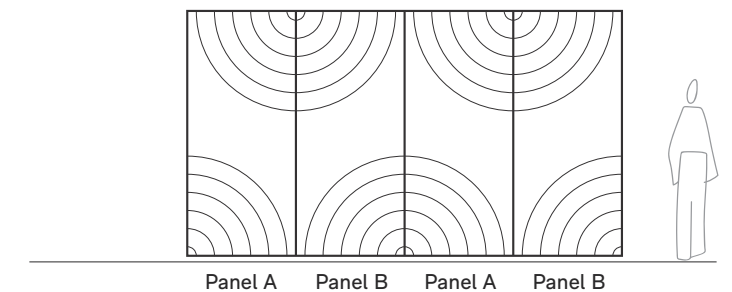

Panel measurements are in inches, and rounded to the nearest 1/8"



Bloc V6



- Bloc style is equally-spaced vertical and horizontal grooves across a panel
- The dimensions listed below are standard options, but can be changed if needed

Contact your Momentum account manager for further options.

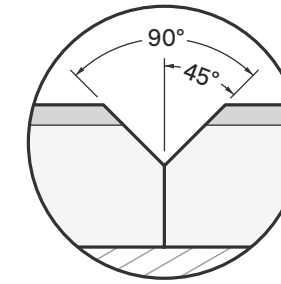

Panel side-edges are beveled with half of the specified groove angle for seamless panel joints

Panel A

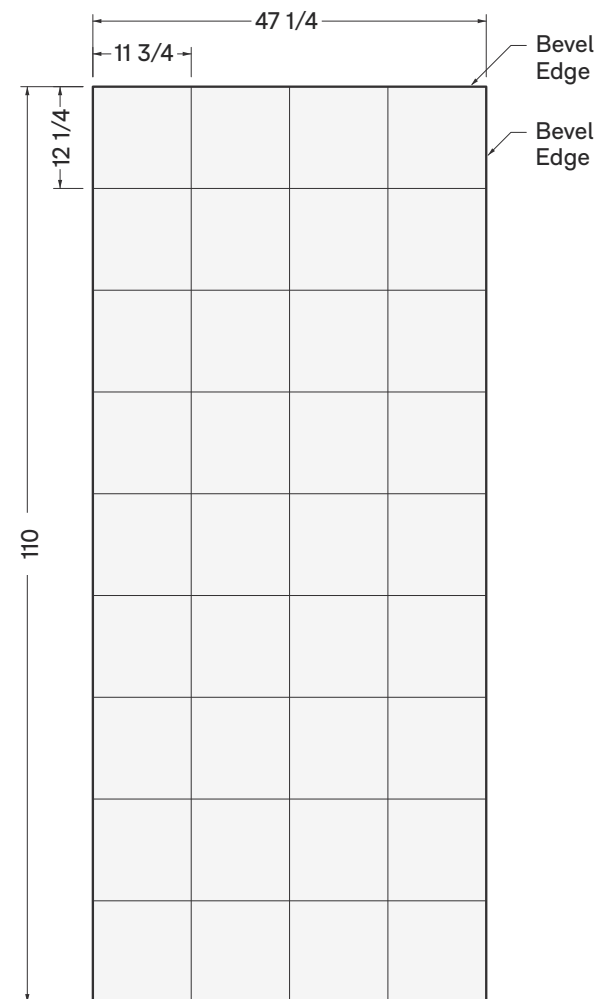

Layout Option

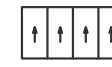

Match

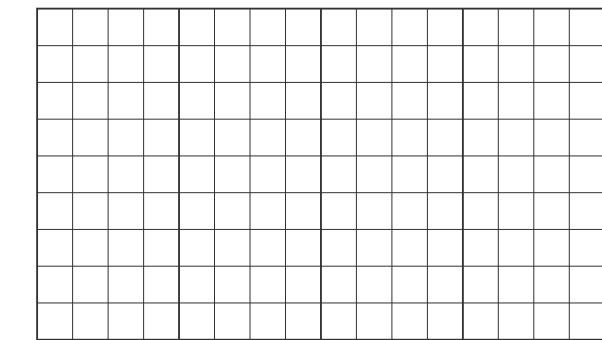

Panel A Panel A Panel A Panel A

Panel measurements are in inches, and rounded to the nearest 1/8"



Bamboo V7

- Bamboo style is irregular vertical spacings with angled grooves between
- The dimensions listed below are standard options, but can be changed if needed
- Unless specified otherwise, orders will be assumed to be all Panel A

Contact your Momentum account manager for further options.

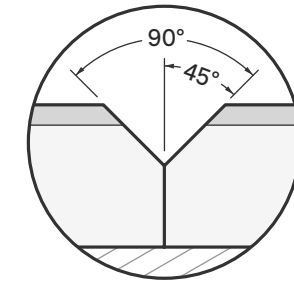

Panel side-edges are beveled with half of the specified groove angle for seamless panel joints

Panel A - Standard

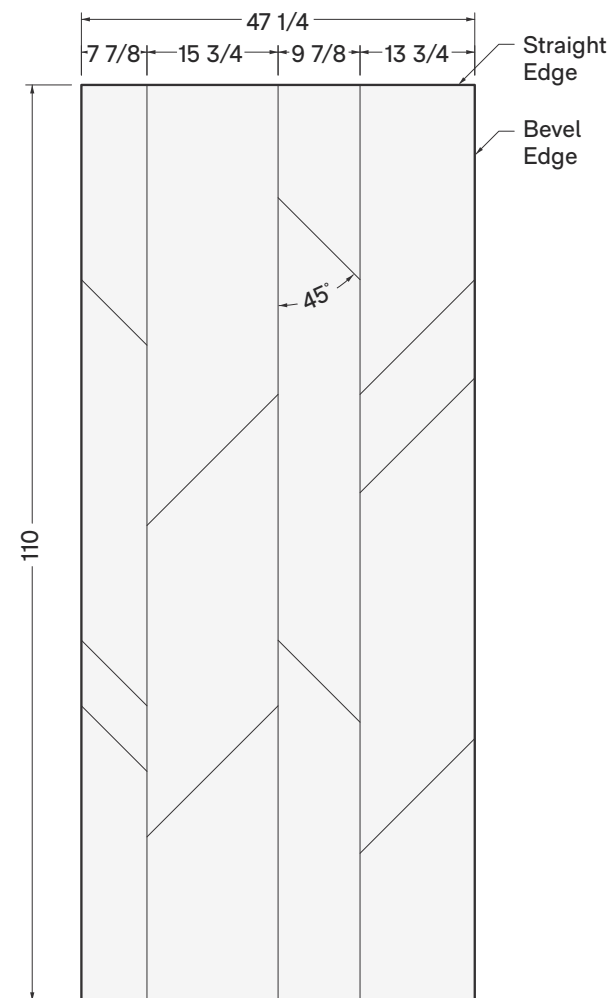

Panel B

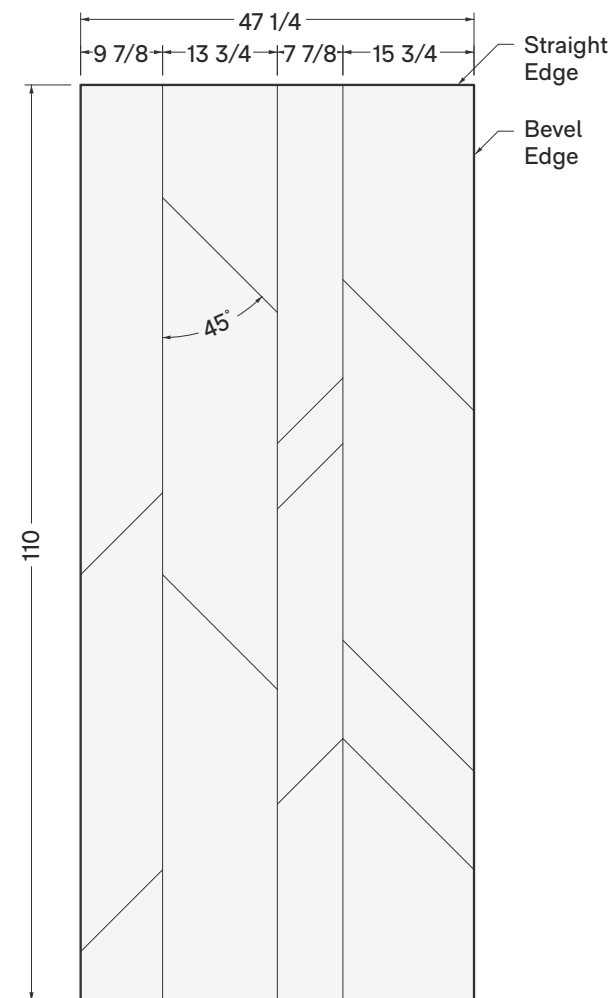

Layout Options

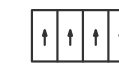

Match

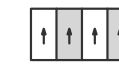
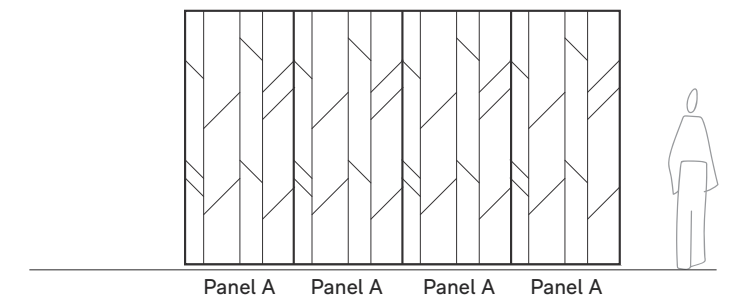

Alternate

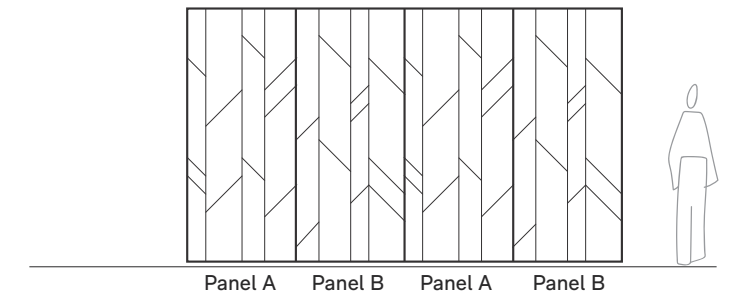

Panel measurements are in inches, and rounded to the nearest 1/8"



Facade V8



- Facade is a division of equal squares with a consistent notch detail in each
- The dimensions listed below are standard options, but can be changed if needed

Contact your Momentum account manager for further options.

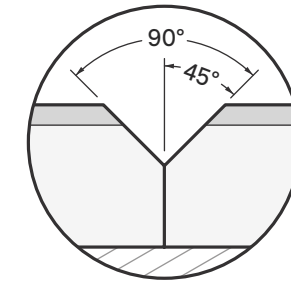

Panel side-edges are beveled with half of the specified groove angle for seamless panel joints

Panel A

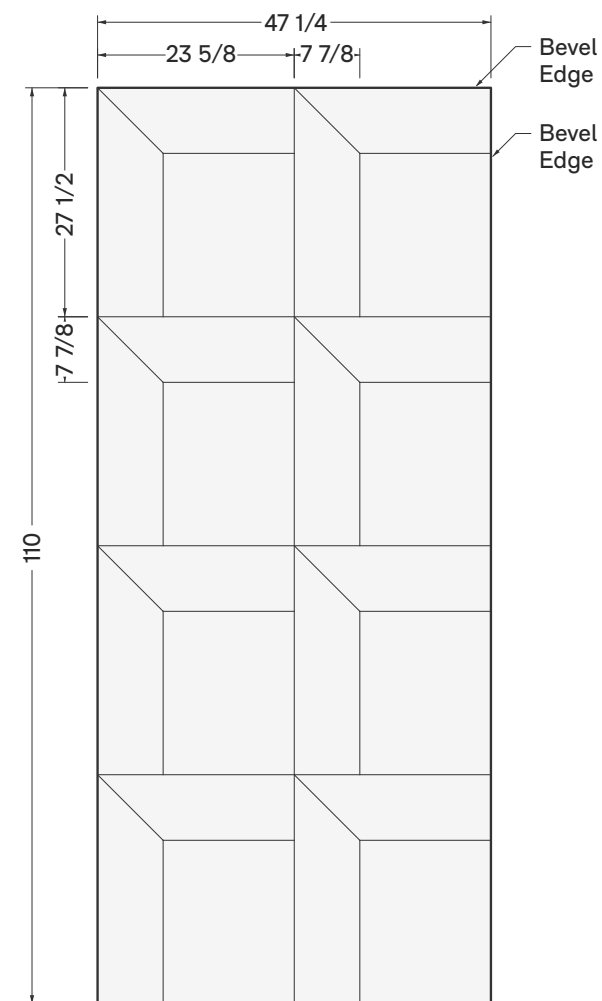

Layout Option

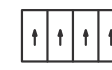

Match

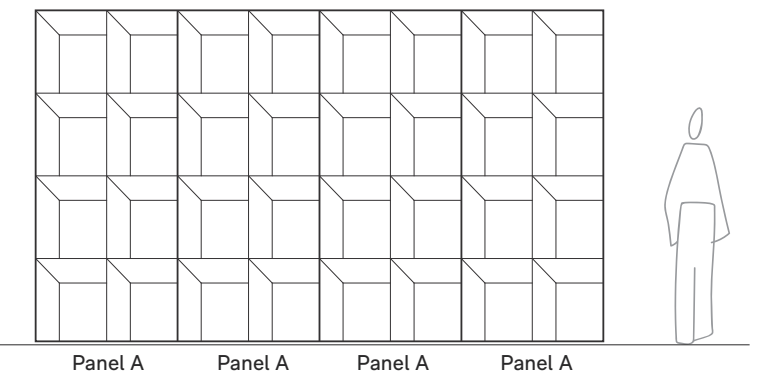

Panel measurements are in inches, and rounded to the nearest 1/8"



Whisp V9



- Whisp is a pair of organic sweeping curves which are rotationally symmetrical
- The dimensions listed below are standard options, but can be changed if needed

Contact your Momentum account manager for further options.

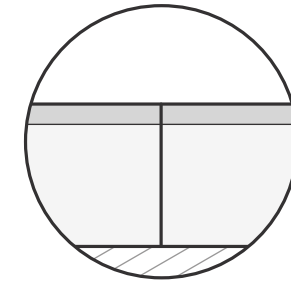

Panel side-edges are straight-cut for seamless panel joints

Panel A



Layout Option

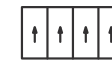

Match

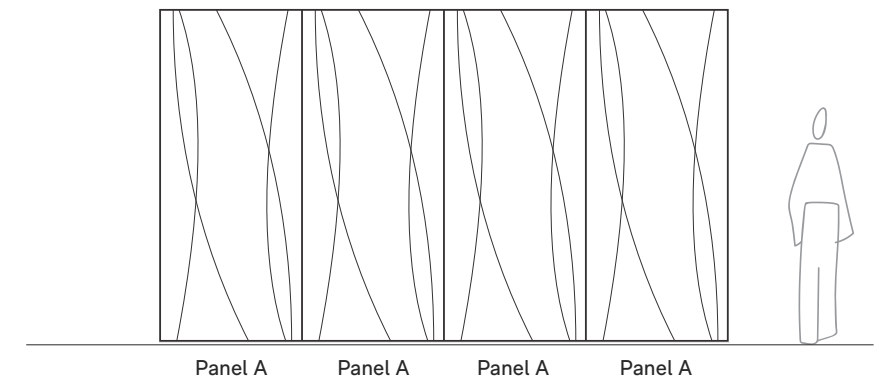



Arc V10



- Arc is a group of sweeping tangent curves, which allow for tessellation on all panel edges
- The dimensions listed below are standard options, but can be changed if needed
- Unless specified otherwise, orders will be assumed to be all Panel A

Contact your Momentum account manager for further options.

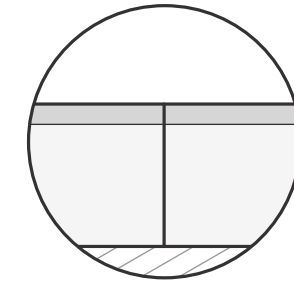

Panel side-edges are straight-cut for seamless panel joints

Panel A - Standard

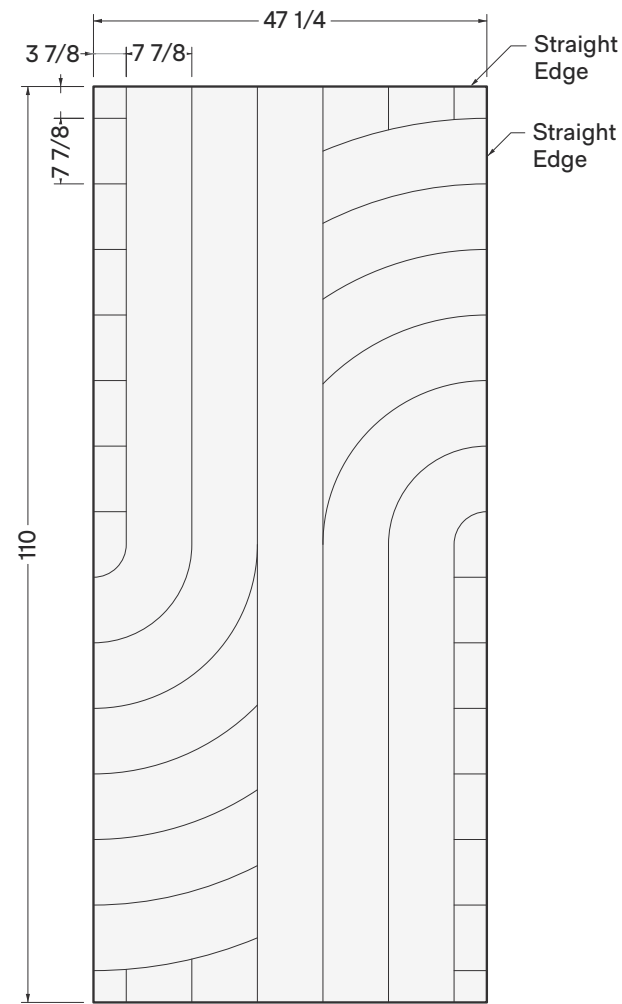

Panel B

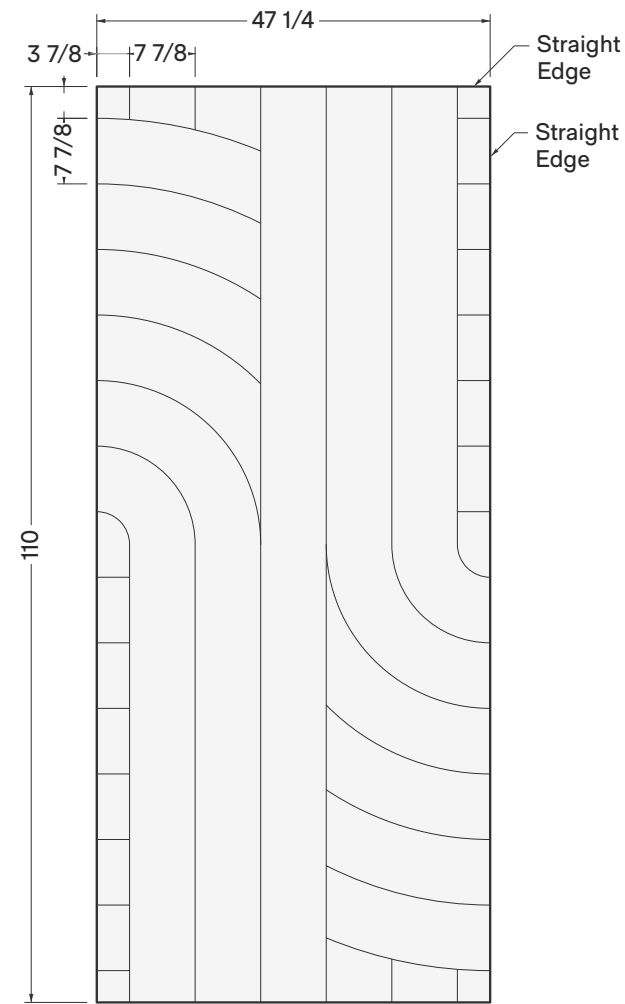

Layout Options

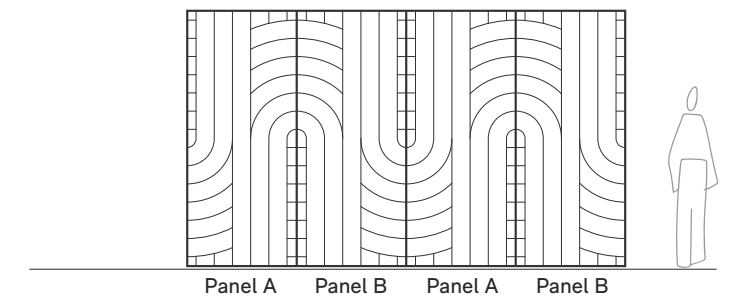
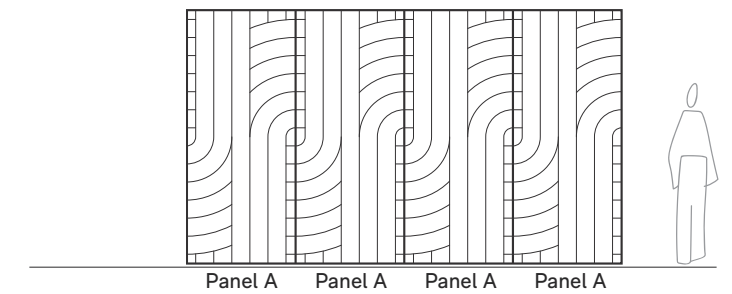
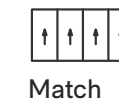



Refract V11



- Refract is a division of equally-spaced vertical and horizontal grooves with an alternating pattern throughout
- The dimensions listed below are standard options, but can be changed if needed

Contact your Momentum account manager for further options.

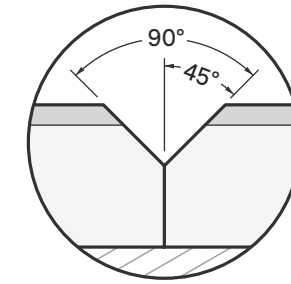

Panel side-edges are beveled with half of the specified groove angle for seamless panel joints

Panel A

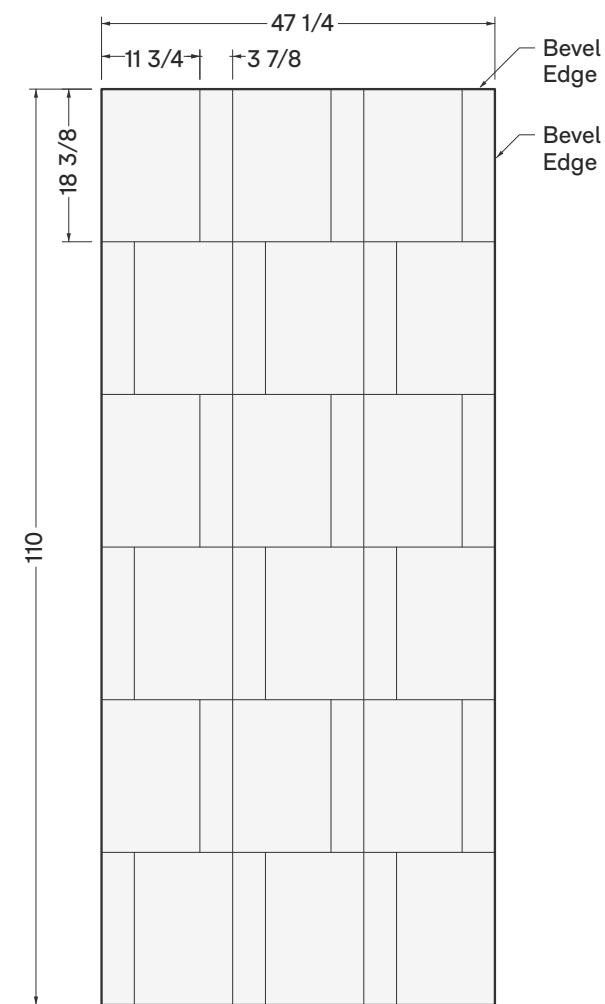

Layout Option

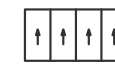

Match

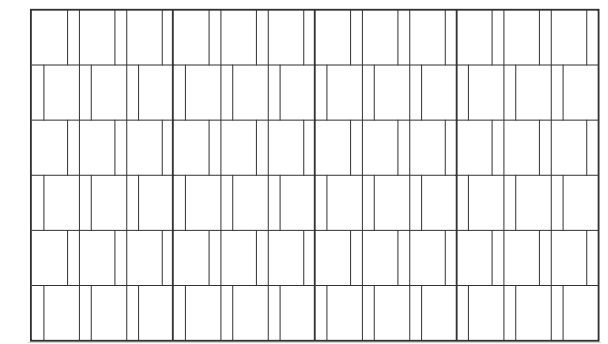

Panel A Panel A Panel A Panel A

Panel measurements are in inches, and rounded to the nearest 1/8"



Nova V12



- Nova is an array of truncated grooves, which collectively make a gridded pattern across panels.
- The dimensions listed below are standard options, but can be changed if needed

Contact your Momentum account manager for further options.

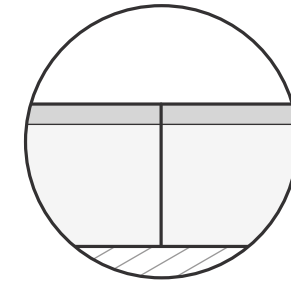

Panel side-edges are straight-cut for seamless panel joints

Panel A

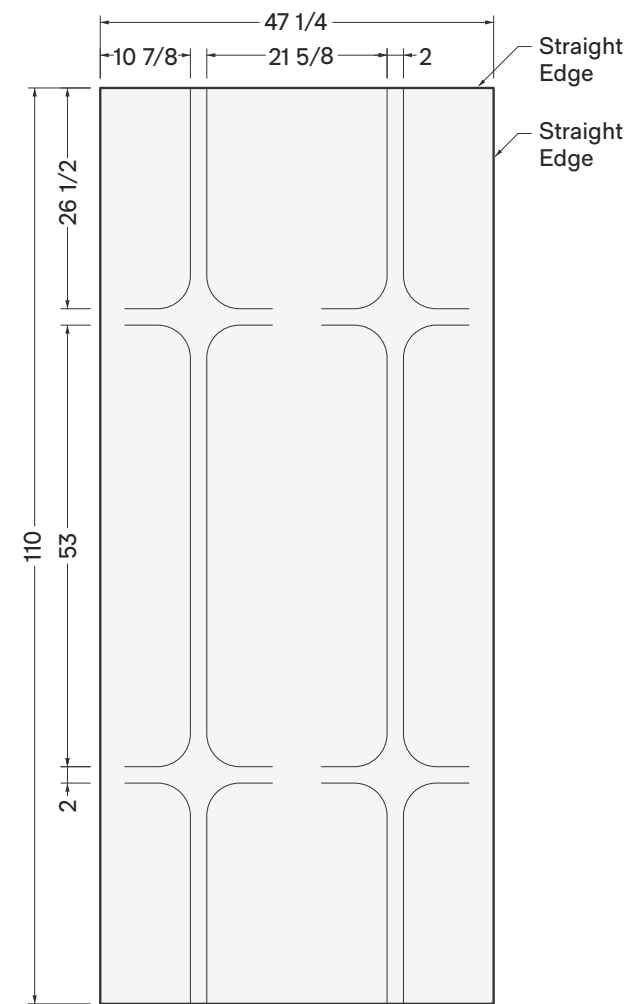

Layout Option

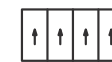

Match

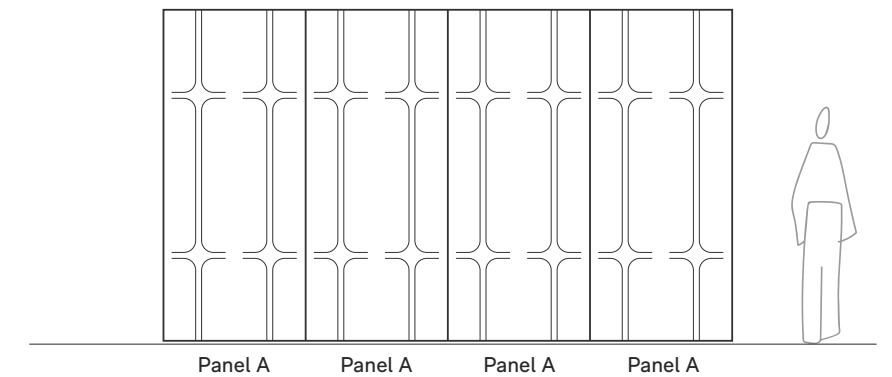



Detail Considerations

Trimming Panel

Groove Duet panels can be cut on-site if required.
We recommend using a snap-blade knife and straight edge.

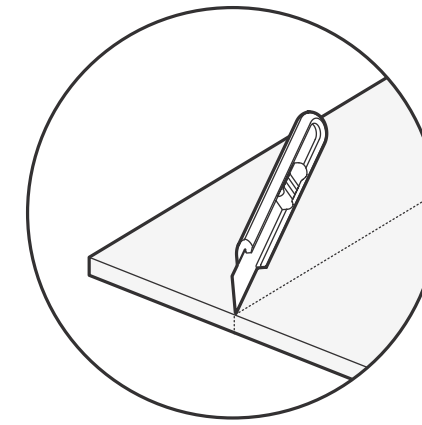

Power Outlets and Light Switches

Measure and cut out where the outlet would sit on the panel.
Apply the panel to the substrate and secure the outlet through the panel.

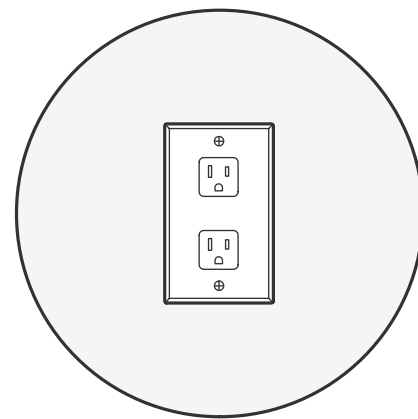

Internal Corners

We recommend a simple lap-join install. If the opposite end of your wall has an exposed edge, we recommend starting the install from that end, and cutting the final panel to fit into this lap join.

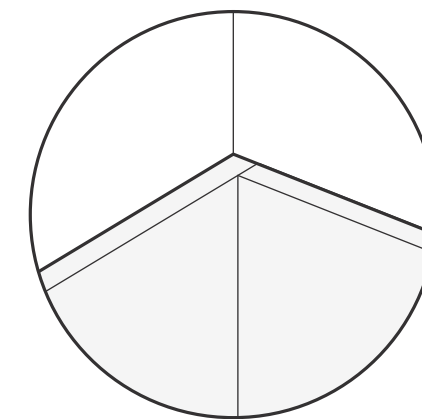

For further installation details, please refer to the Groove Duet Installation Guide.



Top Color

Vertiface® Colors

Groove Duet top layer is available in the full range of Vertiface colors.

Velour finish option available.

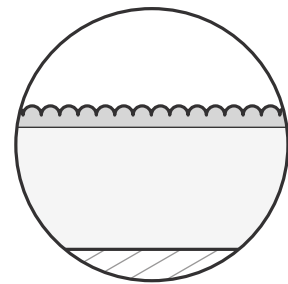

Velour Finish



Savoye



Opera



Parthenon



Senado



Beehive



Simba



Canyon



Vintage



Myst



Terrace



Cavalier

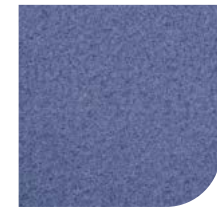

Calypso

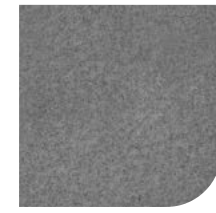

Flatiron



Blazing Red



Chilli Red



Sargazo



Porcelain



Stonewash



Atlantis



Electric Blue



Muralla



Ink

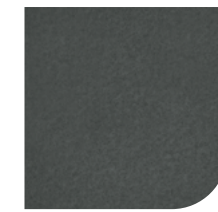

Caspian



Pinnacle



Falling Water

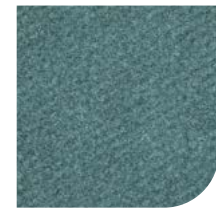

Spearmint

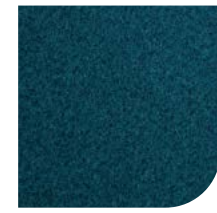

Octane

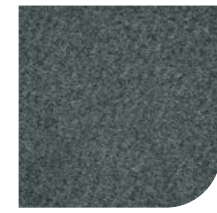

Sage



Koala



Empire

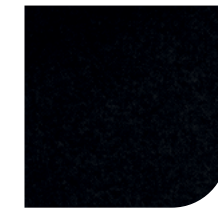

Petronas

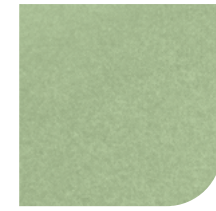

Acros

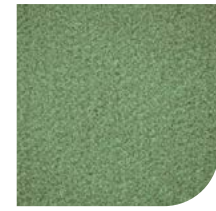

Jade



Granny Smith



Lime



Highland



Gherkin



Tree House



Base Color

Cube™ Colors

Groove Duet base panels are available in the full range of Cube colors.



Pavilion



Opera



Parthenon



Senado



Beehive



Terrace



Canyon



Sargazo



Savoye



Rushmore



Flatiron

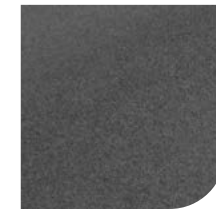

Herald

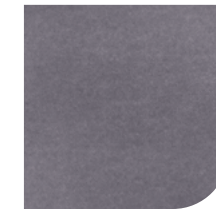

Cavalier

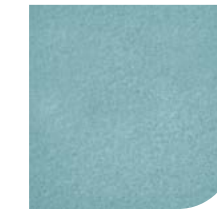

Falling Water



Muralla



Pinnacle

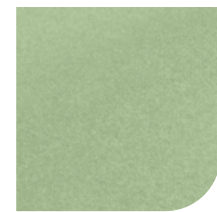

Acros

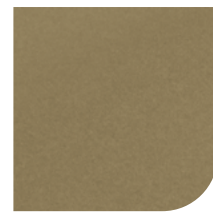

Highland



Gherkin



Tree House

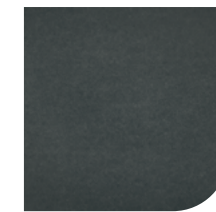

Caspian

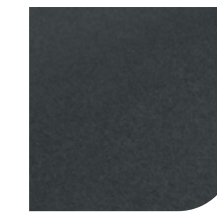

Empire



Petronas



Sound Materials



We're on a positive journey towards momentous change. It's about winning for the planet and its people, making a difference for healthy generations to come.

Sustainability is ingrained in everything we do, from fiber to finish. Our commitment to doing good now and in the future drives us to continuously evolve our practices, design with integrity, and take responsibility for the impact of our products. Our five sustainability pillars reflect this ethos, guiding our actions and shaping our decisions. Together, these pillars form a system that ensures our materials, products, and processes contribute meaningfully to a more sustainable world.



01



Climate change demands climate action

We are carbon neutral in everything we do.

02



Closing the loop

We are advocates for closing the loop on waste. We design with circularity front of mind.

03



Sustainable supply chain

We carefully select responsible suppliers and take action to mitigate unethical practices, and encourage good working conditions.

04



Supporting wellbeing in buildings

All our products are made using only safe materials. No harmful chemicals are present in our products.

05



Operating a business for purpose and profit

We strive to have a positive impact on our environment, our people, and the next generation.

Credentials

Sustainability isn't just a feature—it's a foundation. Our products are independently certified by trusted third-party certifications and labels to meet rigorous environmental and performance standards.

Our products also meet criteria for WELL, LEED, Green Star, and BREEAM building rating systems, helping you achieve certification for your project.



Declare.





Our Journey to Nature Positive



We want to make a material difference to the planet and its people. That's why we're not resting on achieving carbon neutrality across the organization and our products.

We're on a journey committed to Nature Positive, which ultimately delivers systems and products that contribute to biodiversity replenishment, carbon sequestration, and many positive environmental outcomes.

It's manufacturing that cares for human beings and the generations to come.

1967
Founded in Auckland, NZ, creating underfelt for the flooring industry.



1990
Established on-line recycling systems.

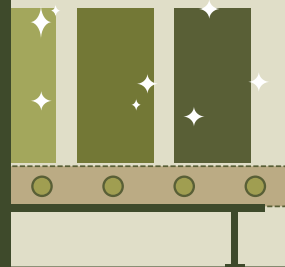

2020
Dematerialization project, which reduced raw material use by 30% for core product.



2017
First Environmental Product Declarations (EPDs) were published and started measuring GHG emissions.



2012
Reclaimed waste trimmings, reducing raw material use and associated emissions.

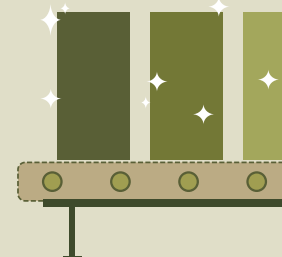

2021
We balanced all emissions from our acoustic products to zero.



2022
We balanced all emissions from our global operations to zero.



2025
We received the first NaturePositive+ Declaration in the construction industry for our first carbon negative product we launched in New Zealand. It uses a material with a -8.6 CO₂e carbon footprint.



Technical Information

Overview

NRC	0.40 - 0.70 and higher
Content	100% PET, min. 80% recycled
Form	Panel
Dimensions	47 1/4" x 110" (1200mm x 2794mm)
Thickness	3/8" (9mm), 1" (24mm)
Origin	Fabricated in the USA

Acoustic Performance

Groove Duet is specifically designed to reduce and control reverberation and echo noise in building interiors.

Frequency (Hz)	125	250	500	1000	2000	4000	NRC
● 3/8" Groove Duet	0.00	0.05	0.25	0.55	0.80	0.90	0.40
● 1" Groove Duet	0.05	0.25	0.65	0.95	1.00	1.00	0.70

Fire Considerations

ASTM E-84-15a: **Class A rating** (Test RJ9445F-1a)
 CAN/ULC-S102 (Test QA-2243F-3) 3/8" only
 Fire test reports available on request.

Twenty Year Manufacturer's Guarantee

Product Specifications

Hard body impact There is no surface damage or penetration when subjected to hard body impacts. When adhered to 0.39" (10mm) plasterboard, the system can resist a 9 joule impact.

Soft body impact There is no surface damage or penetration when subjected to soft body impacts. When adhered to 0.39" (10mm) plasterboard, the system can resist a 70 joule impact.

Microbial resistance (ASTM G21-15):
 Growth rating: 0

Color fastness to light (ISO 105-B02:2014):
 Rating: 6

Determination of colorfastness to rubbing (ISO 105-X12:2016):
 Dry assessment: 4 - 5
 Wet assessment: 4 - 5

Average % of water vapor sorption by weight after four days: 0.4%

For care and maintenance guidance, view the product Care and Maintenance Guide.

