

# WING

PERSONAL MIXING CONSOLE

## WING Remote Protocols



OSC remote control, MIDI SYSEX, Binary Interfaces,  
and wapi, an API for WING

[V3.0.5 - Wing FW 3.0.5 and above]

# Table of Contents

Introduction.....	7
About this document.....	7
General features of the WING console.....	7
Wing, a family.....	8
WING:.....	9
Rack:.....	9
Compact:.....	10
Sources vs. Inputs.....	11
WING Internal Data.....	12
WING File System.....	12
OS partition.....	13
Data Partition.....	13
Remote communications with WING.....	14
Keeping connections alive.....	14
Number of simultaneously connected applications.....	14
Accessing WING Internal Data and Functions from remote programs.....	14
OSC Remote Protocol.....	17
OSC Data Types.....	17
WING OSC Messages.....	18
Reading (Get) Parameter and Node data.....	18
Receiving OSC data on a specific port.....	19
Writing (Set) Parameter and Node data.....	19
Single Parameters.....	19
Enumerated strings.....	20
Node Data.....	20
Special Node Type/Arguments.....	22
OSC: Special Cases.....	24
JSON Structure dynamic changes.....	24
OSC Tag Type 'blob' or 'binary' use.....	25
Subscribing to OSC Data.....	28
WING ae_data OSC commands list.....	29
Status.....	29
General Configuration.....	30
System Settings.....	34
Input/Output Settings.....	35
Channel Settings.....	41
Aux Settings.....	46
Bus Settings.....	49
Mains Settings.....	52
Matrix Settings.....	55
DCA Settings.....	58
Mutegroup Settings.....	58
Effects Settings.....	59
Cards Settings.....	60
USB Player Settings.....	62
WING ce_data OSC commands list.....	63
Control Settings.....	63
Global Settings.....	80

WING native / binary data interface .....	82
Communication Channels .....	82
Sample receive routine .....	83
Sample transmit routine .....	83
Channel 2: Audio Engine .....	84
Binary Stream Format .....	84
Channel 3: Metering .....	86
Meter Request Tokens .....	86
Meter Data .....	87
Introducing wapi (wapi) .....	88
wapi tokens .....	88
Compiling a program using wapi .....	89
wapi Reference Guide .....	91
Open and Close .....	91
int wOpen(char* wip) .....	91
void wClose() .....	91
int wVer() .....	91
Setting Values .....	92
int wSetTokenFloat(wtoken token, float fval) .....	92
int wSetTokenInt(wtoken token, int ival) .....	92
int wSetTokenString(wtoken token, char* str) .....	92
Getting Values .....	93
wtype wGetType(wtoken token) .....	93
char* wGetName(wtoken token) .....	93
whash wGetHash(wtoken token) .....	94
int wGetToken(wtoken token, wtype *type, wvalue *value) .....	94
int wGetTokenFloat(wtoken token, float* fval) .....	95
int wGetTokenInt(wtoken token, int* ival) .....	95
int wGetTokenString(wtoken token, char* str) .....	96
int wGetTokenDef(wtoken token, int *num, unsigned char* str) .....	96
int wGetTokenTimed(wtoken token, wtype *type, wvalue *value, int timeout) .....	97
int wGetTokenFloatTimed(wtoken token, float *fval, int timeout) .....	97
int wGetTokenIntTimed(wtoken token, int *ival, int timeout) .....	97
int wGetTokenStringTimed(wtoken token, char* str, int timeout) .....	98
A Small Program Example .....	99
Event-driven updates .....	100
int wKeepAlive .....	100
int wGetParsedEvents(wTV *tv, int maxevents) .....	100
int wGetParsedEventsTimed(wTV *tv, int maxevents, int timeout) .....	100
Nodes .....	102
int wSetNode(char *str) .....	103
int wSetNodeFtomTVArray(wTV *array, int nTV) .....	103
int wSetBinaryNode (unsigned char *array, int len) .....	103
int wGetNode(wtoken node, char *str) .....	104
int wGetNodeToTVArray (wtoken node, wTV *array) .....	104
int wGetBinaryNode (wtoken node, unsigned char *array, int maxlen) .....	106
int wGetBinaryData (char *str, unsigned char *array, int maxlen) .....	107
Meters .....	108
Meters API .....	108
int wMeterUDPPort (int wport) .....	108

int wSetMetersRequest(int reqID, unsigned char *wMid).....	108
int wRenewMeters(int reqID) .....	109
int wGetMeters(unsigned char *buf, int maxlen, int timeout) .....	109
RTA test program .....	111
Effects and Plugins .....	115
Plugins.....	115
Effects .....	117
Channel strips layers .....	120
WING MIDI Remote-Control channels use.....	122
WING MIDI SYSEX .....	123
SYSEX Messages format .....	123
SYSEX Messages, Explained.....	124
Examples.....	124
cmd = 00 example:.....	124
cmd = 02 examples: .....	125
cmd = 03 examples: .....	125
cmd = 05 examples: .....	126
Appendix: Buttons (user/gpio, user/user, user/daw, user/) .....	128
user/gpio/1.4 .....	128
user/user/1.4 .....	128
user/daw1..4/1.4 .....	128
user/1..16/1.4 .....	128
Appendix: Effects and Plugins' Parameters list .....	132
Effects .....	132
Standard effects.....	132
Premium effects.....	140
Channel effects .....	147
Plugins.....	152
Filter plugins .....	152
Gate plugins .....	153
EQ plugins .....	155
Compressor plugins .....	158
Appendix: Routing.....	162
Input Routing .....	163
Output Routing .....	166
Advanced Routing Options .....	168
USER SIGNAL.....	168
USER PATCH.....	170
Appendix: Shows, Scenes (Snaps, Snippets, Presets & Audio Clips).....	172
Shows.....	172
Scenes.....	172
Snaps.....	173
Snippets .....	173
Presets .....	173
Audio Clips .....	174
Controlling Scenes and Shows via MIDI .....	174
Item Tags and arbitrary MIDI data .....	174
Appendix: Scopes and Safes.....	176

Library Scopes .....	176
CONTENTS Scopes (orange Icons).....	176
CONFIGURATION Scopes (blue icons) .....	177
CONFIG .....	177
SFC .....	177
PREFS .....	177
L, C, R, CC, CMPCT, RCK, EXT, VRT.....	177
Not Saved in Snapshots:.....	177
Console Init Scopes .....	178
Global Safes .....	179
Appendix: WING Startup Control.....	180
Appendix: MIDI Setup for REAPER Control Surface Use.....	181
REAPER Audio Setup .....	182
MIDI .....	182
WING MIDI setup.....	182
REAPER MIDI setup .....	184
Appendix: WING Icons .....	188
Appendix: WING Colors .....	190
Appendix: WING GPIOs:.....	191
Description.....	191
Electrical connections .....	191
Power-on delay .....	192
GPIO precedence on USER/LAYER CC GPIO function .....	192
Appendix: MCU [DAW BUTTONS] commands list .....	193
Appendix: MCU [DAW V-POTS] commands list.....	194
Appendix: MCU [DAW REMOTE MCU] commands list.....	195
Appendix: WING Snapshot and JSON Data Structure: .....	196
Wing Snapfile .....	196
Description.....	196
scopes .....	197
ae_data .....	198
ce_data .....	214
globals.....	218
More JSON files.....	218

# Introduction

# Introduction

## About this document

My name is Patrick-Gilles Maillot and I am authorized by Behringer to publish and maintain this “WING remote protocols” document; I am not a MusicTribe employee.

Starting with release 2.0 of the WING firmware, OSC and native remote protocols form a single (this) document under two separate sections, and share the same series of appendix chapters.

Most users will probably find it easier to remote access their WING with **OSC** commands while more advanced programming and less restricted control are possible using **native** commands and the Wing API (**wapi**) library.

Dedicated chapters provide additional details on MIDI, Custom Controls, Effects, Plugins, Shows, Snap and Snippets and much more.

I want to thank the Behringer dev team for their continuous support in writing this document.

## General features of the WING console

In 2019, Behringer has been designing a whole new digital mixing desk they would later call “personal mixing console”. The WING was unveiled to the public in November 2019 and first shipments took place in December. As to why calling it a “personal Mixing Console”, here is a perfectly valid answer from one of the fathers of the console: “A fundamental idea of WING was providing a high level of customization options to the engineer, allowing to adapt the console surface to his personal preferences and needs”.

The WING console was awaited by several X32 and M32 users as it carried the promise of new features, long expected since the first release the X32 and M32 family of digital mixing desks. It seems the WING receives a warm welcome from the community.

The Behringer WING provides 48-channel, 28-bus mixing with 24 motorized faders and a large 10” capacitive-touch LED screen. The desk is designed for live performance, live and studio recording, touring sound, A/V, club installs, and more. Three separate fader sections and a custom controls section can be easily and intuitively tailored to personal requirements.

The 48-channel inputs [in/aux] and 28-channel mixes [bus/matrix/main] can all be in mono/stereo or mid-side mode, with specific source mutes and metering, and provide dynamics, EQ and FX processing. They too can be given a color, icon, name and up to 8 console or user defined tags for grouping and filtering purposes. WING input channels provide low-cut & high-cut filters, tilt-EQs, all-pass or Sound Maxer, in addition to a 6-band parametric EQ. All buses, matrices, and mains feature 8-band parametric EQ. All channels and buses can also load high-end simulations modeled from hardware devices such as Pultec EQ, SSL Bus Compressor and Gate/Expander, SPL Transient Designer, Neve EQ, Compressor and Gate, Focusrite ISA and D3, DBX160, LA-2A, 1176, Elysia mPressor, Empirical Labs Distressor, and more. The built in FX rack supports 8 true stereo processors including TC VSS3 algorithms, Lexicon, Quantec, and EMT emulations. Other processing includes modulation, equalization, dynamics, nonlinear effects and four guitar amplifiers with cabinet simulations. A maximum of 16 stereo inserts can be used for applying internal FX or outboard processing to input channels or buses.

The channel editing section provides instant channel status overview and flow of operation. It allows working on the selected channel processing, even when the main display is used for something completely unrelated. Touch-sensitive rotary controls allow you to display the most relevant information, all at your fingertips. The central Custom Controls section<sup>1</sup> offers user-assignable controls including 4 rotary encoders and 20 buttons with 2 LCDs that can be set as functions readily available.

A big rotary wheel offers fine-adjustments for up to 8 user parameters or can be used for DAW remote control via USB MIDI.

The control configuration also includes predefined functionality for USB and SD-card recorder transport, show control and mute groups.

WING includes 8 (full size console) or 24 (Rack and Compact consoles) original MIDAS PRO microphone preamps and 8 XLR outputs with professional quality specifications. 8 TRS line auxiliary ins and outs help bring in signals from media players or computers.

A brand new StageCONNECT<sup>2</sup> interface allows connecting breakout boxes and delivers up to 32 channels of low-latency input or output over a single standard XLR microphone cable.

WING can accommodate 376 inputs<sup>3</sup> and 374 outputs thanks to 3 AES50 SuperMAC audio networking ports, which connect to digital stageboxes. In addition, 144 input and 144 output streams can be shared with other mixing consoles.

There are 48 channels of USB audio and 64 channels of Audio over IP (AoIP module optional), plus AES/EBU stereo I/O. The WING expansion card slot features the LIVE SD recording card with 64x64 channels of audio or can accommodate option cards for various standards such as ADAT, MADI, DANTE, and WSG.

All digital processing takes place on 40-bit floating point Digital Signal Processors, at 48 or 44.1 kHz, with a 1.3ms round-trip latency<sup>4</sup>.

WING provides MIDI In/Out and 2x2 GPIO (General Purpose Input Output, 1x2 on the compact console) that can be used as console event triggers and external show controls, including power-on delays for external gear that needs sync powering with the console.

Automixing is also implemented, with 2 groups of gain sharing on any 16 input channels. The management of the respective input channel gains depends on the levels received, reducing the sum gain in the group to maintain intelligibility and low noise during meetings, ideal when several speakers are collaborating to corporate events, panels, broadcast applications or house of worship.

## Wing, a family

Starting with FW version 3.0 in fall 2024, WING firmware addresses more devices than the 'big' WING which has been on the market for almost five years. **Note these will be disjoint firmware packages.**

**Compact** and **Rack** are now available and offer the same overall functionality than the initial WING, although the change in format implies modifications, some more important than others. We list below the main/obvious elements of WING, Rack and Compact.

---

<sup>1</sup> Not on all WING family devices, the provided description matches the full-size console, unless mentioned otherwise

<sup>2</sup> <https://www.klarktechnik.com/series.html?category=R-KLARKTEKNIK-STAGECONNECTSERIES>

<sup>3</sup> Not considering User Signal/Patch, FX send, or Bus send entries which overlap with actual sources and would bring this to a virtual value of 470 on the WING

<sup>4</sup> Typical value for In to Out trip without effect or insert.



## WING:

- Large control surface with a Left bank of 12 channel strips, a Center bank of 8 channel strips, a n area with CC encoders and buttons, and a Right Bank of 4 channel strips  
Each bank comes with a specific group select set of buttons (IN, AUX, MATRIX, MAIN, BUS, DCA, USER1, USER2, ...) on its left side
- Each channel strip is stereo and composed of a motorized fader, a MUTE, SOLO and SELECT button, a stereo vu-meter with clip, dynamics, and gate indicators, and a 2-line B/W scribble with a color LED above it
- Big Wheel, 4 cursor Buttons, and a DAW control button for enabling some of the fader banks to control MIDI connected DAWs
- A secondary screen besides the main LCD to control/manage 'in channel' settings such as EQ, COMP, etc.
- 8 local Inputs, 8 Aux inputs, 8 aux outputs, 8 local outputs
- 2 headphones jacks on the consoled rear surface sides (left and right), level control is on the top surface
- 4-pin, 12V XLR lamp socket on the rear of the console
- Main board with Power, 2 Ethernet sockets, a USB port, 3 AES50 ports, 1 StageCONNECT port, AES-BU In and Out ports and an expansion slot fitted with 2 SD recording/playback expansion card.
- 4 GPIO (2 TRS)
- MIDI IN and OUT
- A dedicated section for USB, Monitoring
- A large CC section with 2 sets of 8 buttons for CC, transport controls, and other WING dedicated functions (such as Mute Groups), DAW control and two LCD for displaying active functions
- A dedicated section with 4 additional encoders and 4 buttons and LCD, and 8 buttons to select functions

## Rack:

- 19", 4U rack format
- No wheel, no DAW control button(s)
- 24 Local Inputs (8 on the WING)
- No local Aux IO (8 IN, 8 OUT on the WING)
- 4 headphones outs mapped to the 8 local OUTs at the rear of the console with their own headphone amps for IEM applications
- 1 general headphone out with dedicated level knob on the front
- No faders, and a limited set of buttons on the surface.
- No encoders below the LCD touch screen (controls are only via the touch screen, and two encoders on the right side)
- 1 LCD + set of 4 encoders and 8 buttons CC section, with Layer level indicator, VIEW and >4 <4 buttons
- 4 GPIO (2 TRS)
- MIDI IN and OUT
- No Lamp socket
- A USB socket, and 4 buttons dedicated to selecting INPUT/AUX, BUSES/MAIN, DCA/Mute Groups, and CUST TRANSP (USB, SD1, SD2) on the CC section above
- Same Main board as on WING

## Compact:

- Smaller (19" rack compatible) surface with 3 sets of 4 faders and 1 main fader, with bank layer selection available from a vertical set of buttons on the left side of the console.
- 4-pin, 12V XLR lamp socket on the top surface of the console
- Similar channel strips as on WING
- No wheel, no DAW control button(s). Control is possible from the LCD screen.
- 24 Local Inputs (8 on the WING)
- No local Aux IO (8 IN, 8 OUT on the WING)
- Monitor/USB section on the right side of the screen
- 16 buttons in two vertical sets of 8 with a dedicated LCD acts as a CC section between the 12 faders left and the main fader
- 2 GPIO (1TRS) on the rear of the console (4 GPIO / 2 TRS on the WING)
- MIDI IN and OUT
- 1 headphone lack on the rear of the console (level control is on the top surface)
- Same Main board as on WING

In reading carefully later in this document, you will find out two other 'versions' of WING are available, or at least known in the FW: **'Virtual'** and **'External'** are these two versions; At time of this document, it is not clear what these are for; maybe the support of other connected surfaces or devices.

## Sources vs. Inputs

Unlike many digital or analogue desks, WING makes a clear separation between Sources and Input channels; Historically, consoles focus on input numbers assigned to Channels and Auxes. WING is offering a different perspective by focusing on the Source as the reason for any mixing. Sources can be in mono, stereo, or mid-side mode, own headamp parameters like gain and phantom power, with specific source mute and metering. They can be given a color, icon, name and up to 8 console or user defined tags for grouping and filtering purposes. All of this describes the actual Source first, before being patched to Input channels which focus on processing or mixing.

This patching process (also called “Routing”) is described in a specific “user-guide” like Appendix later in this document to help new users grasp the basic operations involved in assigning a physical source (local or remote) to a channel for mixing, as well as assigning WING processed audio data to a physical output (local or remote).

Sources can be labelled using the WING Co-Pilot app or other means such as **OSC** protocol described later in this document or the **wapi** function calls also presenter in the upcoming chapters<sup>5</sup>, and no matter if the signal is patched to a channel, to SD recording or to any other output, it can always be referred to as its assigned Source label.

### Notes

The internal real-time clock (RTC) is powered by a super-capacitor. If the WING is off mains for more about two weeks, it will most likely lose its clock data.

---

<sup>5</sup> Refer also to <https://github.com/pmaillot/wapi>

## WING Internal Data

Like all digital or programmable devices, WING relies on an internal set of parameters that are stored/saved in non-volatile memory. This enables you to find the console in the same state you left it when powering it OFF. WING data set is very large, and in line with the many features the console offers. Each button, each attribute, color setting, effect, parameter, etc. can be found as an internal variable, member of a hierarchical tree structure.

The WING tree is more than 25000 elements! To organize this large set of internal variables, WING uses a hierarchical tree of data, starting with a root and dispatching parameters into logical groups (sub-trees or branches) until the last element (leaves) that represent the actual parameter.

For example, the `fader` associated to `channel1` is part of the `channels` sub-tree, and is one of the many attributes of channel 1. The channel sub-tree is part of the `audio-engine`, itself at the root level.

A quick representation would be as shown below:

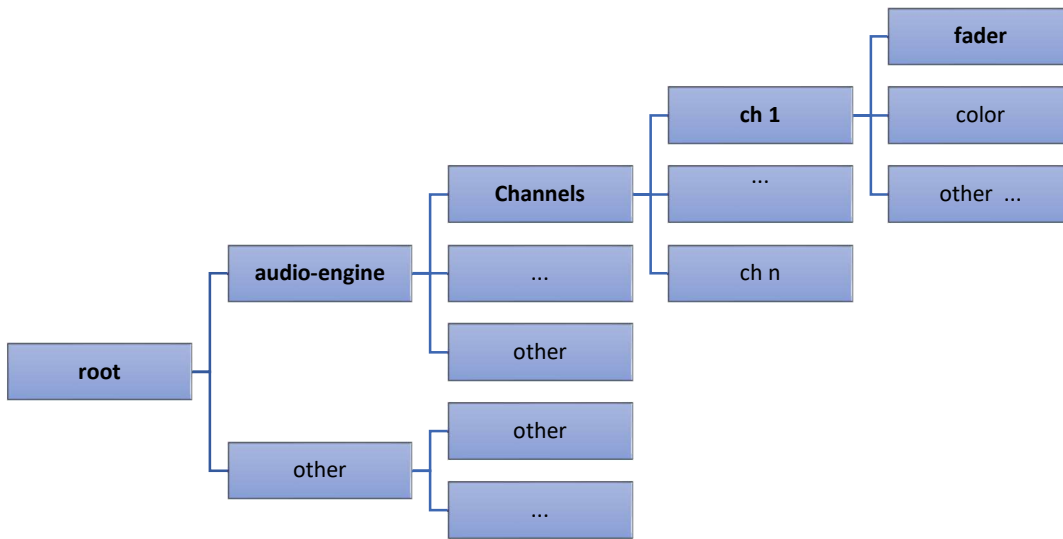

Computers use specific data structures to represent trees. WING uses one of them, based on `JSON`<sup>6</sup> notation. It is important to know/understand the list of sub-trees (nodes), and leaves (parameters) WING contains as this is how you can access to data. More detail on the WING data set is provided in appendix.

## WING File System

At the difference of the X32, WING can be directly connected to a computer via USB; There are two ways WING can be visible to your computer, depending on the setting of the `SETUP`→`GENERAL` screen (shown below, with WING connected as an active data partition):

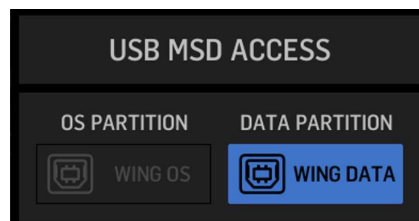

<sup>6</sup> JavaScript Object Notation: an efficient way to represent structured objects. Also used as a data-interchange format.

When actively connected to your PC either as an OS partition or a Data partition, the status at the top of the WING screen will show a red OS or DATA tag.



## OS partition

WING can be seen as an **OS PARTITION**, a directory where you can deposit the FW release you will use to boot from at next power up or reboot. Use with caution!

## Data Partition

A USB connected WING presents itself as an external disk drive. Therefore, the standard cautions apply when connecting and more important, disconnecting from the computer; ***Ensure you unmount the WING file system to avoid losing data.***

If the choice for **USB MSD ACCESS** in **SETUP→GENERAL** is set to **DATA PARTITION**, the WING file system will show as a standard external USB drive. There may be some folders already there, such as 'global' or 'shows', with subfolders, such as 'global/ch\_presets', 'global/fx\_presets', 'global/routing\_presets', 'global/snapshots'.

## Remote communications with WING

WING communicates via ports 2223 [UDP], and 2222 [UDP, TCP];

Initiating a communication with WING starts with sending the 5 bytes [UDP] datagram 'WING?' to the IP of your WING, port 2222.

WING will reply to the requesting IP and port with the following datagram:

```
'WING,' [c_ip] ',' [c_name] ',' [c_model] ',' [c_serial] ',' [firmware]
```

where

[c_ip]	e.g., '192.168.1.62'
[c_name]	ascii characters
[c_model]	'ngc-full' (standard Wing console)
[c_serial]	serial number (ascii)
[firmware]	version string (ascii)

For its native communication format, WING proposes 14 'communication channels' to enable separation between the different 'engines' or main blocks of the console. The following communication channels are currently in use:

**Control-engine** (a TCP communication channel) is using channel #1

**Audio-engine** (main TCP communication channel) is using channel #2

**Meters** (UDP communications) are using channel #3

OSC uses a single communication port: 2223

## Keeping connections alive

Open connections will time out after **10 seconds** of inactivity (on the receiving side). One way to keep a connection active is to request at regular intervals of less than 10 seconds some data from the console. There are many data that can be collected, as shown later in this document.

## Number of simultaneously connected applications

WING can simultaneously communicate with up to 16 **connected** 'clients'; The console will reject further connection requests, if the maximum number of simultaneous connections (**16**) is reached.

What we call 'clients' above refer to actual TCP ports that communicate with the console. Some applications may use several ports and this will reduce the actual number of applications that can simultaneously connect and communicate with WING.

UDP communications such as used for OSC do not have this limitation, being "connection-less". WING's OSC remote protocol enables **only one** (1) subscription to data (for receiving event messages) at any given time.

Subscriptions must be kept alive; they automatically die after 10 seconds.

## Accessing WING Internal Data and Functions from remote programs

As mention in the introduction, WING hosts an **OSC** compliant remote protocol server that offers access to the full set of features of the desk. This is described in the "**WING OSC protocol data interface**" chapter below.

WING also offers a native, binary protocol with the capability to access (read or write) parameters of its internal structures and take full advantage of the entire set of features of the digital desk, including remote control. The protocol is fully described in the “**WING native/binary data interface**” chapter below. To help users access the native protocol, a WING API written in C [**wapi**] has been developed and is available at <https://github.com/pmaillot/wapi> to write programs that directly call **wapi** functions.

## WING OSC protocol data interface



# OSC Remote Protocol

WING includes an OSC Remote Protocol server. This enables easy access to remote features for many professional, sound applications and extensions offered by third parties.

**OSC remote control** enables reading and modifying (when possible) all parameters included in the `ae_data` and `ce_data` JSON structures, all part of the main parameter tree.

WING OSC server implementation complies with the **OSC standard**<sup>7</sup> and proposes several ways to access data, parameters, and features. As all OSC compliant servers, the WING OSC server runs in the console and will reply to **UDP** on a specific port: **2223**.

When using standard **UDP** communication, clients will be replied onto their calling port. If needed, a specific feature enables WING to reply to a **UDP port** specified by the connected client, as explained later in this document.

## OSC Data Types

In compliance with the OSC standard, WING supports the following types:

- `int32` (32bits, bi-endian),
- `float32` (32bits, IEEE 754, big endian),
- `string` (non-null ASCII characters followed by a null, followed by 0-3 additional null characters to make the total number of bytes a multiple of 4),
- `blob` (An `int32` size count, followed by one or more bytes of arbitrary binary data, followed by 0-3 additional zero bytes to make the total number of bytes a multiple of 4).

As specified in the OSC standard, the unit of transmission of OSC is an `OSC Packet`. Any application that sends `OSC Packets` is an `OSC Client`; WING embeds and runs an `OSC Server`.

An `OSC Packet` consists of its contents, a contiguous block of binary data, and its size, the number of 8-bit bytes that comprise the contents. The size of an `OSC packet` is always a multiple of 4.

In the case of WING, the contents of an `OSC packet` is always an `OSC Message`, i.e. `OSC Bundles` are not supported. Note that wildcards `'?'` and `'*'` in `Address Patterns` are reserved for special cases.

An `OSC Message` consists of an `OSC Address Pattern` followed by an `OSC Type Tag String` followed by zero or more `OSC Arguments`. Some older implementations of OSC may omit the `OSC Type Tag` string and WING supports this.

- `OSC Address Patterns` always start with the character `'/'`.
- `OSC Type Tags` can be `i`, `f`, `s`, `b` for `int32`, `float32`, `string` and `blob`, respectively
- `OSC Arguments` consist in a single or a contiguous sequence of the binary representations of each argument

The maximum UDP packet size is 32k bytes.

---

<sup>7</sup> See [http://opensoundcontrol.org/spec-1\\_0](http://opensoundcontrol.org/spec-1_0)

## WING OSC Messages

In the following paragraphs, we assume a communication link exists between WING and a client program, and communications take place with a WING console at a known IP address, using UDP on port 2223.

All along this document, the character ‘~’ will represent a NULL byte (\0). Patterns ->W and W-> represent data sent to WING and data received from WING followed by the actual number of bytes transmitted or received, respectively.

Retrieving WING console information can be completed by sending the OSC Address Pattern “/?”

```
->W, 4 B: /?~~~
W->, 80 B: /?~~~,s~~WING,192.168.1.71,PGM,ngc-full,NO_SERIAL,1.07.2-40-g1b1b292b:develop~~~~
```

The actual bytes exchanged are displayed below (OSC is a binary protocol)

```
->W, 4 B: 2f3f0000
W->, 80 B:
2f3f00002c73000057494e472c3139322e3136382e312e37312c50474d2c6e67632d66756c6c2c4e4f5f53455249414c2c
312e30372e322d34302d6731623162323932623a646576656c6f7000000000
```

The line below is using a more compliant OSC format, and will result in the same answer

```
->W, 8 B: /?~~~,~~~
```

## Reading (Get) Parameter and Node data

There are two main ways to gain access to WING data: using one-parameter-at-a-time or using “nodes”.

WING “nodes” are a great way to access multiple parameters at a time, and therefore maximize communication bandwidth with the console. Nodes are represented as **string** OSC Data Type and are zero terminated (\0 byte ending the string).

Nodes are also a good way to discover WING parameters, as they offer easy access to the full map of the JSON internal data structures.

We show below WING’s first layer of JSON structure, and starting at the root, retrieved using OSC.

```
->W, 4 B: /~~~~
W->, 116 B:
/~~~~,ssssssssssssssssssss~~~$stat~~~cfg~~$syscfg~io~~ch~~aux~~bus~~main~~~~mtx~dca~mgrp~~~~fx~~cards~~~pl
ay~~~~rec~~$ctl~~~~
```

Retrieving a WING single parameter is quite easy: You must ensure your OSC request points to a leaf of the JSON structure (i.e. there is no more hierarchy data after the current one). This is for example the case for the fader value of a channel strip, or its mute state. Channel Strip 1 fader is represented as follows:

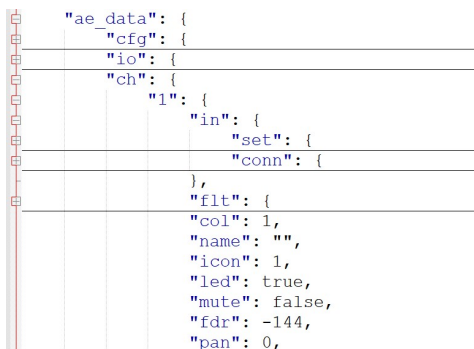

```
  "ae_data": {
    "cfg": {
      "io": {
        "ch": {
          "1": {
            "in": {
              "set": {
                "conn": {
                },
              },
            "flt": {
              "col": 1,
              "name": "",
              "icon": 1,
              "led": true,
              "mute": false,
              "fdr": -144,
              "pan": 0,
            },
          },
        },
      },
    },
  },
```

Or “ch”/”1”/”fdr”, which translates to OSC Address Pattern /ch/1/fdr:

```
->W, 12 B: /ch/1/fdr~~~
```

```
W->, 32 B: /ch/1/fdr~~~,sff~~~-oo~[0.0000] [-144.0000]
```

In the example above, the data [0.0000] [-144.0000] are ascii representation of two 32bits big-endian float data values, each coded on 4 bytes as binary. The binary data actually received is as shown below, and in order to ease the reading of numerical information in this document, we use readable values in brackets rather than the actual binary data. The color highlights are there to help distinguish data elements.

```
W->, 32 B: 2f63682f312f6664720000002c736666000000002d6f6f0000000000c3100000
```

Depending on the OSC Address Pattern, WING returns ',s' for strings or enums, ',sff' (ascii, raw, float value) for floats, ',sfi' (ascii, raw, int value) for ints. In the example above, fader position is a float and WING returns the ascii representation, the raw [0.0. .1.0] data and the actual float value in dB.

Similarly, requesting the mute state of channel strip 1 would return:

```
->W, 12 B: /ch/1/mute~~~
```

```
W->, 32 B: /ch/1/mute~~~,sfi~~~1~~~[1.0000] [ 1]
```

```
W->, 32 B: 2f63682f312f6d75746500002c73666900000000310000003f8000000000000001
```

It should be noted that WING will accept both OSC path or the native hash data for representing nodes or parameters; Indeed, all nodes and parameters in the console are assigned a binary address (a hash) as explained in the chapter on native interface to the console. For example, the channel 1 mute command above can be sent as OSC Address Patterns /ch/1/mute~~~ as shown, or /#f50f69f8~~~, and would return the same data as shown above. 0xf50f69f8 is the hash for command “Channel 1 mute”. The full set of WING hash values can be discovered by recursively traversing the JSON tree of WING nodes/commands, using the native binary interface or OSC protocol, but it is generally more convenient to use the more standard OSC node notation, rather than hexadecimal hash values to address the console features.

## Receiving OSC data on a specific port

Some OSC programs will request that data is returned on a specific port rather than being sent back to the port used by the requesting client for sending data. To enable this capability, WING OSC includes an optional, special notation for all OSC commands:

Any OSC command can be prefixed with the /%<port>, with <port> in the form “12345” to enable receiving the expected answer onto the specified port number. For example, the OSC request:

```
->W, 20 B: /%10027/ch/1/mute~~~
```

Will receive the expected reply from WING on port 10027, as shown below, using a sniffer program on said port. The IP does not change.

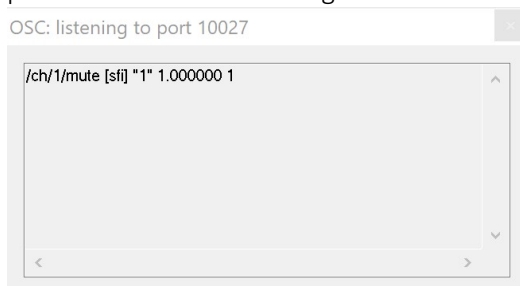

## Writing (Set) Parameter and Node data

### Single Parameters

OSC can be used to set or modify WING data. Taking the fader and mute examples above, we can modify their respective values using OSC commands, sending string, big-endian int32 or big-endian float32 with the corresponding OSC Type Tag following the OSC Address Pattern respective of the parameter to change.

WING does not echo data sent over UDP by the client application. The client application may nevertheless be notified with an OSC event in case of an error.

Individual parameters can be strings, integer, or floats; WING OSC server implementation enables to use several data types and will manage the conversion to ensure proper value setting inside the console. For example, fader position is a floating-point internal value. It can be set as a string or a float using the following OSC commands (in this example setting channel 2 fader position to -2 or -3dB):

```
->W, 20 B: /ch/2/fdr~~~,s~-2~~
->W, 12 B: /ch/2/fdr~~~
W->, 36 B: /ch/2/fdr~~~,sff~~~~-2.0~~~~[0.7000][-2.0000]

->W, 20 B: /ch/2/fdr~~~,f~-[-3.0000]
->W, 12 B: /ch/2/fdr~~~
W->, 36 B: /ch/2/fdr~~~,sff~~~~-3.0~~~~[0.6750][-3.0000]
```

### Enumerated strings

One of the data WING uses is “enumerated strings”, or the choice of one string in a list of elements to represent a specific state or attribute value. For example, /\$ctl/user/1/1/enc/mode can be any of the following strings: OFF, FDR, PAN, DCA, SSND, FSND, FX, DAWMCU, MON, MIDICC, SD A, or SD B

This can be set via a string OSC tag, as shown below if one wants to set the mode parameter to FX:

```
/$ctl/user/1/1/enc
->W, 20 B: /$ctl/user/1/1/enc~~
W->, 52 B: /$ctl/user/1/1/enc~~,sss~~~~mode~~~~name~~~~$fname~~
->W, 24 B: /$ctl/user/1/1/enc/mode~
W->, 32 B: /$ctl/user/1/1/enc/mode~,s~OFF~
/$ctl/user/1/1/enc/mode ,s FX
->W, 32 B: /$ctl/user/1/1/enc/mode~,s~FX~~
/$ctl/user/1/1/enc/mode
->W, 24 B: /$ctl/user/1/1/enc/mode~
W->, 32 B: /$ctl/user/1/1/enc/mode~,s~FX~~
```

But it can also be set as an int OSC tag, using the index of the list corresponding to the targeted value; in the example above, FX sits at index 6 in the list of 10 strings; This enables us to use the following OSC command to set the encoder mode to FX:

```
/$ctl/user/1/1/enc
->W, 20 B: /$ctl/user/1/1/enc~~
W->, 52 B: /$ctl/user/1/1/enc~~,sss~~~~mode~~~~name~~~~$fname~~
->W, 24 B: /$ctl/user/1/1/enc/mode~
W->, 32 B: /$ctl/user/1/1/enc/mode~,s~OFF~
/$ctl/user/1/1/enc/mode ,i 6
->W, 32 B: /$ctl/user/1/1/enc/mode~,i~~[ 6]
/$ctl/user/1/1/enc/mode
->W, 24 B: /$ctl/user/1/1/enc/mode~
W->, 32 B: /$ctl/user/1/1/enc/mode~,s~FX~~
```

One can also note the extensibility character of WING nodes; indeed, after the previous command, the user 1/1 encoder has additional parameters:

```
/$ctl/user/1/1/enc
->W, 20 B: /$ctl/user/1/1/enc~~
W->, 60 B: /$ctl/user/1/1/enc~~,sssss~mode~~~~name~~~~$fname~fx~par~
```

### Node Data

WING nodes can also be used to set multiple values with using a single OSC “/” command, and offer a simple yet effective way to navigate within the hierarchical structure of JSON data. Say you want/need to set fader and mute values to -1 dB, 0 dB, OFF and ON for channels 1 and 2; This can be achieved in a single OSC request using the following syntax:

```
->W, 44 B: /~~~,s~/ch.1.fdr=-1,mute=0,.2.fdr=0,mute=1~
```

Or setting channel 1 fader and mute values to 10 dB and ON, and setting bus 1 fader to 5 dB:

```
->W, 44 B: /~~~,s~/ch.1.fdr=10,mute=1,/bus.1.fdr=5~~~~
```

As shown above, each parameter group is separated by a ',' character, the '/' character represents the root of the JSON parameter tree, and '.' characters are used to navigate up and down within the JSON parameter tree.

The console will reply with /\*~~~,s~~OK~~ if the command was accepted, or one of the following:

```
/*~~~,s~~NODE NOT FOUND~~  
/*~~~,s~~VALUE ERROR~~~~~  
/*~~~,s~~BUFFER OVERFLOW~  
/*~~~,s~~NODE IS NOT PAR~  
/*~~~,s~~INCOMPLETE DATA~  
/*~~~,s~~STACK EMPTY~~~~~
```

if an error occurred during the execution of the command.

**Note:** Nodes can return large amounts of data; as a result, some nodes cannot be returned using OSC/UDP as they would overflow the 32kB UDP buffer limitation; In such situation, WING will return an error OSC message event.

Some nodes examples are provided below:

```
->W, 12 B: /ch/1/fdr~~~  
W->, 32 B: /ch/1/fdr~~~,sff~~~~-oo~[0.0000][-144.0000]  
->W, 12 B: /ch/1/mute~~~  
W->, 32 B: /ch/1/mute~~~,sfi~~~~1~~~[1.0000][ 1]  
->W, 12 B: /ch/2/fdr~~~  
W->, 32 B: /ch/2/fdr~~~,sff~~~~-oo~[0.0000][-144.0000]  
->W, 12 B: /ch/2/mute~~~  
W->, 32 B: /ch/2/mute~~~,sfi~~~~0~~~[0.0000][ 0]
```

```
->W, 44 B: /~~~,s~/ch.1.fdr=-1,mute=0,.2.fdr=0,mute=1~  
W->, 12 B: /*~~~,s~~OK~~
```

```
->W, 12 B: /ch/1/fdr~~~  
W->, 36 B: /ch/1/fdr~~~,sff~~~~-1.0~~~~[0.7250][-1.0000]  
->W, 12 B: /ch/1/mute~~~  
W->, 32 B: /ch/1/mute~~~,sfi~~~~0~~~[0.0000][ 0]  
->W, 12 B: /ch/2/fdr~~~  
W->, 32 B: /ch/2/fdr~~~,sff~~~~0.0~[0.7500][0.0000]  
->W, 12 B: /ch/2/mute~~~  
W->, 32 B: /ch/2/mute~~~,sfi~~~~1~~~[1.0000][ 1]
```

Nodes can also be located deeper in the JSON structure tree. For example, changing a single parameter in the node channel 1 ["/ch/1"] can be done as shown below:

```
->W, 20 B: /ch/1~~~,s~~fdr=3~~~  
W->, 16 B: /ch/1*~~~,s~~OK~~
```

```
->W, 12 B: /ch/1/fdr~~~  
W->, 32 B: /ch/1/fdr~~~,sff~~~~3.0~[0.8250][3.0000]  
->W, 12 B: /ch/1/mute~~~  
W->, 32 B: /ch/1/mute~~~,sfi~~~~0~~~[0.0000][ 0]
```

The OSC command is replied to with an OK status if execution went well; error messages can be returned too, as explained earlier.

The same type of command can be used to set/change several parameters at once; For example, fader and mute values of channel 1 can be done as follows:

```

->W, 28 B: /ch/1~~~,s~~fdr=4,mute=1~~~
W->, 16 B: /ch/1*~~,s~~OK~~

->W, 12 B: /ch/1/fdr~~~
W->, 32 B: /ch/1/fdr~~~,sff~~~4.0~[0.8500][4.0000]
->W, 12 B: /ch/1/mute~~
W->, 32 B: /ch/1/mute~~,sfi~~~1~~~[1.0000][ 1]

```

### Special Node Type/Arguments

There are three special tag/argument that are specifically implemented for nodes. They enable listing the complete set of data, parameter description, and description including values for the node provided as OSC address pattern. The arguments to use are '\*', '?', and '#', respectively. Examples of use are provided below, applied to OSC address pattern /fx/1 when no effect is loaded to keep the description as short as possible.

#### Node data dump:

When using this format, The data returned will strictly correspond to what would be saved in a snap file; Read-only and temporary data are not returned.

```

/fx/1 ,s *
->W, 16 B: /fx/1~~~,s~~*~~~
W->, 32 B: /fx/1~~~,s~~mdl=NONE,fxmix=100,~

```

#### Node parameter description:

```

/fx/1 ,s ?
->W, 16 B: /fx/1~~~,s~~?~~~
W->, 696 B: /fx/1~~~,s~~ mdl list [NONE, EXT, HALL, ROOM, CHAMBER, PLATE, CONCERT,
AMBI, V-ROOM, V-REV, V-PLATE, GATED, REVERSE, DEL/REV, SHIMMER, SPRING, DIMCRS, CHORUS, FLANGER,
ST-DL, TAP-DL, TAPE-DL, OILCAN, BBD-DL, PITCH, D-PITCH, VSS3, BPLATE, GEQ, PIA, DOUBLE, PCORR,
LIMITER, DE-S2, ENHANCE, EXCITER, P-BASS, ROTARY, PHASER, PANNER, TAPE, MOOD, SUB, RACKAMP,
UKROCK, ANGEL, JAZZC, DELUXE, BODY, SOUL, E88, E84, F110, PULSAR, MACH4, C5-CMB, SUB-M, V-IMG,
SPKMAN, DEQ3, *EVEN*, *SOUL*, *VINTAGE*, *BUS*, *MASTER*]~ fxmix lin [0 .. 100 %], 101
steps~ $esrc int [0 .. 400]~ $emode list [M, ST, M/S]~ $a_chn int [0
.. 76]~ $a_pos int [0 .. 1]~~~

```

#### Node description including values:

```

/fx/1 ,s #
->W, 16 B: /fx/1~~~,s~~#~~~
W->, 816 B: /fx/1~~~,s~~ mdl NONE list [NONE, EXT, HALL, ROOM,
CHAMBER, PLATE, CONCERT, AMBI, V-ROOM, V-REV, V-PLATE, GATED, REVERSE, DEL/REV, SHIMMER, SPRING,
DIMCRS, CHORUS, FLANGER, ST-DL, TAP-DL, TAPE-DL, OILCAN, BBD-DL, PITCH, D-PITCH, VSS3, BPLATE,
GEQ, PIA, DOUBLE, PCORR, LIMITER, DE-S2, ENHANCE, EXCITER, P-BASS, ROTARY, PHASER, PANNER, TAPE,
MOOD, SUB, RACKAMP, UKROCK, ANGEL, JAZZC, DELUXE, BODY, SOUL, E88, E84, F110, PULSAR, MACH4,
C5-CMB, SUB-M, V-IMG, SPKMAN, DEQ3, *EVEN*, *SOUL*, *VINTAGE*, *BUS*, *MASTER*]~ fxmix
100 lin [0 .. 100 %], 101 steps~ $esrc 0 r/o int [0 ..
400]~ $emode M r/o list [M, ST, M/S]~ $a_chn 0 r/o
int [0 .. 76]~ $a_pos 0 r/o int [0 .. 1]~~~

```

As a second example, we give below the node data dump for OSC address pattern /ch/1, when loaded with default values after init:

```

/ch/1 ,s *
->W, 16 B: /ch/1~~~,s~~*~~~
W->, 2156 B:
/ch/1~~~,s~~in.set.srcauto=0,altsrc=0,inv=0,trim=0.0,bal=0.0,dlymode=M,dly=0.1,dlyon=0,.conn.grp=L
CL,in=1,altgrp=OFF,altin=1,..flt.lc=0,lcf=100.2,lcs=24,hc=0,hcf=10k02,hcs=12,tf=0,mdl=TILT,tilt=0.
00,.clink=1,col=1,name=,icon=0,led=1,mute=0,fdr=-
oo,pan=0,wid=100,solosafe=0,mon=A,proc=GEDI,ptap=5,peq.on=0,1g=0.0,1f=100,1q=1.00,2g=0.0,2f=999,2q
=1.00,3g=0.0,3f=10k0,3q=1.00,.gate.on=0,mdl=GATE,thr=-
40.0,range=40.0,att=10,hld=10,rel=199,acc=0,ratio='1:3'..gatesc.type=OFF,f=1k0,q=2.00,src=SELF,tap
=IN,.eq.on=0,mdl=STD,mix=100,lg=0.0,lf=80.2,lq=1.00,leq=SHV,1g=0.0,1f=200.0,1q=1.00,2g=0.0,2f=601.

```

4,2q=1.00,3g=0.0,3f=1k50,3q=1.00,4g=0.0,4f=3k99,4q=1.00,hg=0.0,hf=12k00,hq=1.00,heq=SHV,.dyn.on=0,  
mdl=COMP,mix=100,gain=0.0,thr=-  
10.0,ratio=3.0,knee=3,det=RMS,att=50,hld=20,rel=153,env=LOG,auto=1,.dynxo.depth=6.0,type=OFF,f=1k0  
,.dynsc.type=OFF,f=1k0,q=2.00,src=SELF,tap=IN,.preins.on=0,ins=NONE,.main.1.on=1,lv1=0.0,pre=0,.2.  
on=0,lv1=0.0,pre=0,.3.on=0,lv1=0.0,pre=0,.4.on=0,lv1=0.0,pre=0,.send.1.on=0,lv1=-  
oo,pon=0,mode=PRE,plink=0,pan=0,.2.on=0,lv1=-oo,pon=0,mode=PRE,plink=0,pan=0,.3.on=0,lv1=-  
oo,pon=0,mode=PRE,plink=0,pan=0,.4.on=0,lv1=-oo,pon=0,mode=PRE,plink=0,pan=0,.5.on=0,lv1=-  
oo,pon=0,mode=PRE,plink=0,pan=0,.6.on=0,lv1=-oo,pon=0,mode=PRE,plink=0,pan=0,.7.on=0,lv1=-  
oo,pon=0,mode=PRE,plink=0,pan=0,.8.on=0,lv1=-oo,pon=0,mode=PRE,plink=0,pan=0,.9.on=0,lv1=-  
oo,pon=0,mode=GRP,plink=1,pan=0,.10.on=0,lv1=-oo,pon=0,mode=GRP,plink=1,pan=0,.11.on=0,lv1=-  
oo,pon=0,mode=POST,plink=1,pan=0,.12.on=0,lv1=-oo,pon=0,mode=POST,plink=1,pan=0,.13.on=0,lv1=-  
oo,pon=0,mode=POST,plink=1,pan=0,.14.on=0,lv1=-oo,pon=0,mode=POST,plink=1,pan=0,.15.on=0,lv1=-  
oo,pon=0,mode=POST,plink=1,pan=0,.16.on=0,lv1=-oo,pon=0,mode=POST,plink=1,pan=0,.MX1.on=0,lv1=-  
oo,pon=0,mode=PRE,plink=0,pan=0,.MX2.on=0,lv1=-oo,pon=0,mode=PRE,plink=0,pan=0,.MX3.on=0,lv1=-  
oo,pon=0,mode=PRE,plink=0,pan=0,.MX4.on=0,lv1=-oo,pon=0,mode=PRE,plink=0,pan=0,.MX5.on=0,lv1=-  
oo,pon=0,mode=PRE,plink=0,pan=0,.MX6.on=0,lv1=-oo,pon=0,mode=PRE,plink=0,pan=0,.MX7.on=0,lv1=-  
oo,pon=0,mode=PRE,plink=0,pan=0,.MX8.on=0,lv1=-  
oo,pon=0,mode=PRE,plink=0,pan=0,.tapwid=100,postins.on=0,mode=FX,ins=NONE,w=0.0,.tags=,~~~

## OSC: Special Cases

### JSON Structure dynamic changes

As parameters get changed on the WING console, its JSON structure tree evolves to reflect the changes; This can be a specific parameter that when changing to an ON state, offers new capabilities in the audio chain, or in the way the console will react.

It is also typical of **effects** and **plugins**: WING consoles support dynamic allocation of effect or plugins that can generate large changes within the default JSON tree. As already mentioned, WING nodes are a great way to list the parameters available for a given effect and therefore a way to get and possibly set effect parameter values.

The WING effects and plugins, and their respective parameters are listed later in this document<sup>8</sup>.

The OSC commands below show how you can access effects slots, allocate an effect, and list parameters and later modify effect parameter values.

Accessing effects with currently no effect loaded in effect slot 1, listing the effect node:

```
->W, 4 B: /fx~
W->, 88 B:
/fx~, sssssssssssssss~1~2~3~4~5~6~7~8~9~10~11~12~13~14~15~16~

->W, 8 B: /fx/1~
W->, 60 B: /fx/1~, ssssss~mdl~fxmix~$esrc~$emode~$a_chn~$a_pos~
->W, 12 B: /fx/1/mdl~
W->, 24 B: /fx/1/mdl~, s~NONE~
```

Loading a PIA effect in effect slot 1:

```
->W, 20 B: /fx/1/mdl~, s~pia~
->W, 12 B: /fx/1/mdl~
W->, 20 B: /fx/1/mdl~, s~PIA~
```

PIA effect is now loaded, listing the effect Node gives a different set of parameters:

```
->W, 8 B: /fx/1~
W->, 120 B:
/fx/1~, sssssssssssssss~mdl~fxmix~$esrc~$emode~$a_chn~$a_pos~mix~g~31~63~125~250~50
0~1k~2k~4k~8k~16k~
```

We can now get/set effect 1 PIA parameters, for example the 125Hz band:

```
->W, 12 B: /fx/1/125~
W->, 32 B: /fx/1/125~, sff~0.0~[0.5000][0.0000]
```

The 125Hz band is at 0dB, change it to 10dB and verify the change:

```
->W, 20 B: /fx/1/125~, f~[10.000]
->W, 12 B: /fx/1/125~
W->, 36 B: /fx/1/125~, sff~10.0~[0.9233][10.000]
```

---

<sup>8</sup> Please refer to the “Effects” paragraph



## OSC Tag Type 'blob' or 'binary' use

WING OSC server implementation supports the 'blob'/'binary' OSC Tag type, enabling the use of 'native' commands<sup>9</sup> within OSC, making it possible with the proper information at hand to send and receive binary data.

An alternative to standard node requests (such as the request on root below) is to use binary.

```
->W, 4 B: /~~~  
W->, 116 B:  
/~~~,ssssssssssssss~$stat~$cfg~$syscfg~io~ch~aux~bus~main~mtx~dca~mgrp~fx~cards~pl  
ay~rec~$ctl~
```

Binary types typically apply on WING nodes to retrieve the internal binary equivalent of the JSON tree level respective of a WING node.

Shown below is a request at root level using the native commands part of the binary data [all bytes sent shown as hex data]

```
/ ,b dd
```

Data actually sent (in hex): ->W, 16 B: 2f0000002c62000000000001dd000000

WING's reply is:

```
W->, 440 B: /~~~,b~425 bytes:  
df0018000000097a0043900000524737461740553544154450000df001100000000edca7af900000363666700000df00  
150000000f89818a60000072473797363666700000df00130000000294f7794000002696f03492f4f0000df00170000  
000070b101390000026368074348414e4e454c0000df001c000000008fa3078d0000036175780b415558204348414e4e45  
4c0000df001400000000f46c185e000003627573034255530000df00160000000004d3a3a80000046d61696e044d41494e  
0000df001700000000f82a5af20000036d7478064d41545249580000df001400000000e313aef00000364636103444341  
0000df001c00000000d252398b0000046d6772700a4d5554452047524f5550000df001700000000473c91340000026678  
07454646454354530000df002200000000b4296fc900000563617264730f455850414e53494f4e2043415244530000df00  
18000000057297a28000004706c617906504c415945520000df001900000000fab1762c000003726563085245434f5244  
45520000df001900000000cbb951430000042463746c07434f4e54524f4c0000de
```

Lots of information are returned either as string, or more often as blob/binary. In the reply above, after each 'df' byte is a data length on two bytes, immediately followed by the binary address (the hash) where a node, parameter, or subtree data can be found. For example, the subtree entry for channel (/ch) can be found at address/hash 70b10139

An example on retrieving the DAW node (hash is df17c242, part of the \$ctl subtree) is shown below. Sending the OSC blob:

```
/$ctl/daw ,b dd  
or  
/ ,b d7df17c242dd
```

Respectively translate in the following binary data being sent to the console:

```
->W, 24 B: 2f2463746c2f6461770000002c62000000000001dd000000  
or  
->W, 20 B: 2f0000002c62000000000006d7df17c242dd0000
```

To which the console replies with (it can also reply with one of the errors listed earlier in the OSC chapters):

```
W->, 876 B: /$ctl/daw~~~,b~856 bytes:  
df0022df17c2423cb129d50000026f6e0a44415720454e41424c4500400000000000000001df0028df17c2424e5c7f3400  
0004636f6e6e0a434f4e4e454354494f4e005000020344494e000355534200df0027df17c242e5681680000004656d756c  
09454d554c4154494f4e00500002034d4355000348554900df0071df17c24242701ca9000006636f6e6669670000500004  
02434314435553544f4d20434f4e54524f4c53204f4e4c59044d5354520a53494e474c45204d4355084d53545231455854  
0e4d4355202b20455854454e444552084d53545232455854114d4355202b20327820455854454e444552df002edf17c242  
ae1538a400000463637570145553452055050455220434320464f522044415700400000000000000001df0035df17c242  
9fa4e7320000066469736a6f671944495341424c4520574845454c20445552494e4720504c415900400000000000000001
```

<sup>9</sup> Detail information on native commands is provided in a separate chapter

```
df0097df17c242892e512d000006707265736574124c415354204c4f414445442050524553455400500008012d012d0663
756261736506435542415345046c697665044c495645066c6f67696378074c4f4749432058066e75656e64f064e55454e
444f0870726f746f6f6c730950524f20544f4f4c5306726561706572065245415045520973747564696f6f6e650a535455
44494f204f4e45df001fdf17c242beefaeab000003246f6e06444157204f4e024000000000000001df0027df17c24296
31559f0000062462706167650b425554544f4e20504147450040000000000000004df0031df17c242012dc54600000924
62746e746f7563681242544e53454c20464144455220544f554348004000000000000001df002adf17c242775c19c200
00082462746e76706f740c42544e53454c20562d504f54004000000000000001df002ddf17c24242aeb92800000a2462
746e7265637264790d42544e53454c20524543524459004000000000000001df0029df17c242fccfbee07000008246274
6e6175746f0b42544e53454c204155544f00400000000000000001df002adf17c24285cdce3f0000082462746e7673656c
0c42544e53454c20562d53454c004000000000000001df002ddf17c24215abd96800000a2462746e696e736572740d42
544e53454c20494e53455254004000000000000001de
```

The above is more difficult to read than the more standard way of retrieving the node, but contains more information:

```
->W, 12 B: /$ctl/daw~~~
W->, 156 B:
/$ctl/daw~~~, sssssssssssss~on~~conn~~~~emul~~~~config~~ccup~~~~preset~~$on~$bpage~~$bntouch~~~$b
tnvpot~~~~$bntnrecrdy~~$bntnauto~~~~$bntnysel~~~~$bntninsert~~
```

Matching the two representations tell us that:

```
daw/on is at binary address 3cb129d5,
daw/conn at 4e5c7f34,
daw/emul at e5681680,
daw/config at 42701ca9,
daw/ccup at ae1538a4,
daw/preset at 892e512d,
daw/$on at beefaeab,
and so on (highlighted values above).
```

The blob /binary Type Tag can also be used to execute native/binary commands. Using for example the daw/\$on hash/binary address value of beefaeab, we can set the console in and out of DAW mode, as if one would have pressed the DAW button.

For example, sending any of the following commands will set DAW mode ON:

```
/ ,b d7beefaeab01
->W, 20 B: /~~~,b~~6 bytes: d7beefaeab01
W->, 12 B: /*~~,s~~OK~~
/$ctl/daw/$on ,b 01
->W, 28 B: /$ctl/daw/$on~~~,b~~1 bytes: 01~~~
W->, 12 B: /*~~,s~~OK~~
```

In the binary data sent with the line above, the segment 01 is equivalent to asking the value of the parameter to be set using a 32bit integer with value 1.

The following lines are requesting to turn OFF DAW mode:

```
/ ,b d7beefaeab00
->W, 20 B: /~~~,b~~6 bytes: d7beefaeab00
W->, 12 B: /*~~,s~~OK~~
/$ctl/daw/$on ,b 00
->W, 28 B: /$ctl/daw/$on~~~,b~~1 bytes: 00~~~
W->, 12 B: /*~~,s~~OK~~
```

In both blob Type Tag commands above, the console replies with a blob. Depending on the cases, it can also return strings.

As seen above, the Tag Type blob can be used to retrieve the description of WING parameters when using the native command 'data description' a.k.a. 'dd'; In an example below, still using the DAW ON state, we can get the data using the following command:

```
/$ctl/daw/$on ,b dd  
->W, 28 B: /$ctl/daw/$on~~~,b~~1 bytes: dd~~~
```

WING returns the following which includes the hash value for /\$ctl/daw/\$on and its full description:

```
W->, 60 B: /$ctl/daw/$on~~~,b~~35 bytes:  
df001fdf17c242beefaeab000003246f6e06444157204f4e0040000000000000001de  
parse 35 bytes node  
  len: 31, parent: df17c242, hash: beefaeab, index: 0, flags: 0040  
  name: $on longname: DAW ON, type: <int> [0..1]
```

End node

The blob Tag Type can be used to retrieve the value of WING parameters when using the native command 'data request', a.k.a. 'dc'; In an example below, still using the DAW ON state, we can get the data using the following command:

```
->W, 20 B: /~~~,b~~6 bytes: d7beefaeabdc  
W->, 20 B: /~~~,b~~7 bytes: d7beefaeab01de
```

With 01 indicating the DAW [Remote control] button is in an ON state.

Detailed information on the native/binary interface to WING and data value coding is provided later in this document.

## Subscribing to OSC Data

There are three main types of subscription for receiving binary or OSC messages.

A single OSC subscription is active at any time, provided to the last requestor. Subscriptions must be renewed every 10 seconds to keep the subscription alive by sending one of the 3 messages shown below.

`/*b~` (or `/*b~,~~~`) will enable receiving event driven binary messages

Binary messages are formatted exactly as the binary/native interface and therefore can be sent back to the console with no change.

Example using mutes and faders

```
->W,    4 B: /*b~
W->,   32 B: /~~~,b~~20 bytes: d738ae75c2d5c310000d77e463474d5c3100000
W->,   24 B: /~~~,b~~12 bytes: d7f50f69f801d726855cd301
```

`/*s~` (or `/*s~,~~~`) will enable receiving event OSC messages

OSC messages are received as triplets of data, as previously presented<sup>10</sup>, and shown below; Sending back data to WING will require to select one of the (up to) 3 parameters received, depending on the chosen format. The 'string' argument will always work for all messages.

Example using mutes and faders

```
->W,    4 B: /*s~
W->,   32 B: /ch/1/fdr~~~,sff~~~~-oo~[0.0000][-144.0000]
W->,   32 B: /ch/1/$fdr~~~,sff~~~~-oo~[0.0000][-144.0000]
W->,   32 B: /ch/1/mute~~~,sfi~~~~1~~~[1.0000][ 1]
W->,   32 B: /ch/1/$mute~~~,sfi~~~~1~~~[0.5000][ 1]
```

`/*S~` (or `/*S~,~~~`) will enable receiving event OSC messages

OSC messages are received as single tag data, as shown below; WING reports the native format of the OSC pattern (ex: 'f' for floats, 'i' for integers, etc.). Data received with events resulting of a `/*S~` subscription can be sent back to the console with no change.

Example using mutes and faders

```
->W,    4 B: /*S~
W->,   20 B: /ch/1/fdr~~~,f~~[-144.0000]
W->,   20 B: /ch/1/$fdr~~~,f~~[-144.0000]
W->,   20 B: /ch/1/mute~~~,i~~[ 1]
W->,   20 B: /ch/1/$mute~~~,i~~[ 1]
```

Using the simple forms of subscription requests will provide data from the console to the requesting IP/port. It is possible to redirect the data received from WING by prefixing the commands with a port specifier element as shown below:

`/%23456/*b~` will subscribe to binary messages, being sent by WING to port 23456.

`/%23456/*s~` will subscribe to OSC messages, being sent by WING to port 23456.

`/%23456/*S~` will subscribe to OSC messages, being sent by WING to port 23456.

---

<sup>10</sup> Refer to "Writing (Set) Parameter and Node data", paragraph "Single Parameters"

## WING ae\_data OSC commands list

The next chapters provide an abridged<sup>11</sup> list of all OSC commands available for WING.

All commands and parameters below are part of the *ae\_data* section in JSON snapshot files. Other console control commands part of the *ce\_data* section in JSON snapshot files are described later in this document.

### Status

Command	Type	Range	Text	Description
/ \$stat	N			Status node
/ \$stat/A	N			AES50 A node
/ \$stat/A/stat	S		-, OK, ERR, UPD	AES50 A state [RO]
/ \$stat/A/dev	S		128 chars max	AES50 A Device [RO]
/ \$stat/B	N			AES50 B node
/ \$stat/B/stat	S		-, OK, ERR, UPD	AES50 B state [RO]
/ \$stat/B/dev	S		128 chars max	AES50 B Device [RO]
/ \$stat/C	N			AES50 C node
/ \$stat/C/stat	S		-, OK, ERR, UPD	AES50 C state [RO]
/ \$stat/C/dev	S		128 chars max	AES50 C Device [RO]
/ \$stat/lock	I	0..1		Clock lock [RO]
/ \$stat/ppm	I	-200..200		Clock ppm [RO]
/ \$stat/solo	I	0..1		Solo [RO]
/ \$stat/sip	I	0..1		Solo In Place [RO]
/ \$stat/rtcerr	I	0..1		Real Time Clock Error [RO]
/ \$stat/time	S		12 chars max	Clock time (depending on time format) [RO]
/ \$stat/date	S		12 chars max	Clock date (depending on date format) [RO]
/ \$stat/usbstate	S		-, ERR, IDLE, BUSY	USB Player state [RO]
/ \$stat/usbvolname	S		20 chars max	USB Player volume name [RO]
/ \$stat/sc_stat	S		OK, ERR	StageConnect status [RO]
/ \$stat/sc_devices	S		128 chars max	StageConnect devices [RO]
/ \$stat/sc_upcnt	I	0..32		StageConnect upstreams [RO]
/ \$stat/sc_dncnt	I	0..32		StageConnect downstreams [RO]
/ \$stat/sc_uprout	S		32 char max	StageConnect upstream routing [RO]
/ \$stat/rmt_a	S		16 chars max	Name of the console connected on AES50 port A [RO]
/ \$stat/rmt_b	S		16 chars max	Name of the console connected on AES50 port A [RO]
/ \$stat/rmt_c	S		16 chars max	Name of the console connected on AES50 port A [RO]

<sup>11</sup> It includes the set of commands for the first element of a series. For example, /ch/1 set of OSC commands are listed, but not /ch/2 to /ch/40.

## General Configuration

Command	Type	Range	Text	Description
/cfg	N			General Configuration node
/cfg/mainlink	S		OFF, 2, 2-3, 2-4	Main Link
/cfg/dcamgrp	I	0..1		DCA mutegroups (DCA mute mutes all channels assigned to DCA)
/cfg/mon	N			Monitor buses config node
/cfg/mon/1	N	1..2		Monitor bus 1 node
/cfg/mon/1/\$lvl	F	-144..10	-∞..10 in 1024 steps	Monitor bus 1 level (dB) <sup>12</sup>
/cfg/mon/1/inv	I	0..1		Monitor bus 1 invert (polarity)
/cfg/mon/1/pan	F	-100..100	201 steps	Monitor bus 1 pan
/cfg/mon/1/wid	F	-150..150	61 steps	Monitor bus 1 width (%)
/cfg/mon/1/eq	N			Monitor bus 1 EQ node
/cfg/mon/1/eq/on	I	0..1		Monitor bus 1 EQ off/on
/cfg/mon/1/eq/lsg	F	-15..15	301 steps	Monitor bus 1 EQ low shelf gain (dB)
/cfg/mon/1/eq/lsf	F	20..2000	641 steps	Monitor bus 1 EQ low shelf frequency (Hz)
/cfg/mon/1/eq/1g	F	-15..15	301 steps	Monitor bus 1 EQ band 1 gain (dB)
/cfg/mon/1/eq/1f	F	20..20000	961 steps	Monitor bus 1 EQ band 1 frequency (Hz)
/cfg/mon/1/eq/1q	F	0.44..10	181 steps	Monitor bus 1 EQ band 1 Q
/cfg/mon/1/eq/2g	F	-15..15	301 steps	Monitor bus 1 EQ band 2 gain (dB)
/cfg/mon/1/eq/2f	F	20..20000	961 steps	Monitor bus 1 EQ band 2 frequency (Hz)
/cfg/mon/1/eq/2q	F	0.44..10	181 steps	Monitor bus 1 EQ band 2 Q
/cfg/mon/1/eq/3g	F	-15..15	301 steps	Monitor bus 1 EQ band 3 gain (dB)
/cfg/mon/1/eq/3f	F	20..20000	961 steps	Monitor bus 1 EQ band 3 frequency (Hz)
/cfg/mon/1/eq/3q	F	0.44..10	181 steps	Monitor bus 1 EQ band 3 Q
/cfg/mon/1/eq/4g	F	-15..15	301 steps	Monitor bus 1 EQ band 4 gain (dB)
/cfg/mon/1/eq/4f	F	20..20000	961 steps	Monitor bus 1 EQ band 4 frequency (Hz)
/cfg/mon/1/eq/4q	F	0.44..10	181 steps	Monitor bus 1 EQ band 4 Q
/cfg/mon/1/eq/5g	F	-15..15	301 steps	Monitor bus 1 EQ band 5 gain (dB)
/cfg/mon/1/eq/5f	F	20..20000	961 steps	Monitor bus 1 EQ band 5 frequency (Hz)
/cfg/mon/1/eq/5q	F	0.44..10	181 steps	Monitor bus 1 EQ band 5 Q
/cfg/mon/1/eq/6g	F	-15..15	301 steps	Monitor bus 1 EQ band 6 gain (dB)
/cfg/mon/1/eq/6f	F	20..20000	961 steps	Monitor bus 1 EQ band 6 frequency (Hz)
/cfg/mon/1/eq/6q	F	0.44..10	181 steps	Monitor bus 1 EQ band 6 Q
/cfg/mon/1/eq/hsg	F	-15..15	301 steps	Monitor bus 1 EQ high shelf gain (dB)
/cfg/mon/1/eq/hsf	F	50..20000	833 steps	Monitor bus 1 EQ high shelf frequency (Hz)
/cfg/mon/1/lim	F	-40..0	41 steps	Monitor bus 1 limiter level(dB)
/cfg/mon/1/dly	N			Monitor bus 1 delay node
/cfg/mon/1/dly/on	I	0..1		Monitor bus 1 delay off/on
/cfg/mon/1/dly/m	F	0.1..100	1000 steps	Monitor bus 1 delay (meters)

<sup>12</sup> This command is considered RO on the full-size WING, and can be set for other devices where the actual surface control potentiometer is not present.

/cfg/mon/1/dim	F	40..0	41 steps	Monitor bus 1 delay dim level (dB)
/cfg/mon/1/pfldim	F	40..0	41 steps	Monitor bus 1 PFL Dim (dB)
/cfg/mon/1/eqbdtrim	F	0..24	25 steps	Monitor bus 1 band solo trim {dB}
/cfg/mon/1/srclvl	F	-144..10	-oo..10 in 1024 steps	Monitor bus 1 source level
/cfg/mon/1/srcmix	F	-144..10	-oo..10 in 1024 steps	Monitor bus 1 source mix (dB)
/cfg/mon/1/src	S		OFF, MAIN.1..MAIN.4, MTX.1..MTX.8, BUS.1..BUS.16, AUX.1..AUX.8	Monitor bus 1 source
/cfg/mon/1/\$lvlact	F	-144..10	-oo..10 in 1024 steps	Monitor bus 1 fader level [RO]
/cfg/mon/1/tags	S		Up to 80 chars	Monitor bus 1 tags
/cfg/solo	N			Solo config node
/cfg/solo/mode	S		LIVE, STUDIO, SIP	Solo mode
/cfg/solo/mon	S		A, B, A+B	Solo monitor
/cfg/solo/mute	I	0..1		Solo mute
/cfg/solo/\$dim	I	0..1		Solo dim off/on
/cfg/solo/\$mono	I	0..1		Solo mono off/on
/cfg/solo/\$flip	I	0..1		Solo left and right channels flipped
/cfg/solo/chtap	S		PFL, AFL	Solo channel tap
/cfg/solo/bustap	S		PFL, AFL	Solo bus tap
/cfg/solo/maintap	S		PFL, AFL	Solo main tap
/cfg/solo/mtxtap	S		PFL, AFL	Solo matrix tap
/cfg/solo/srcsolo	S		OFF, CH39, AUX7	Source Solo Enable
/cfg/solo/\$srcsolo	I	0..1		Source Solo
/cfg/solo/\$srcsgrp	I	1..13		Source Solo Group
/cfg/solo/\$srcsin	I	1..64		Source Solo In
/cfg/rta <sup>13 14</sup>	N			RTA config node (dsp)
/cfg/rta/\$src	I	1..76		RTA source [RO]
/cfg/rta/\$tap	S		IN, POST, FILT, PREEQ, POSTEQ, PREFDR, GATEK, DYNK, DYNXO, PRETAP, SOLO, MON.A, MON.B, FXIN, FXOUT	RTA source tap [RO]
/cfg/rta/\$dec	S		SLOW, MED, FAST	RTA Decay [RO]
/cfg/rta/\$det	S		PEAK, RMS	RTA Detector [RO]
/cfg/rta/rtaSrc	I	0..76		*RTA source (indexed)
/cfg/rta/rtaTap	S		IN, POST, FILT, PREEQ, POSTEQ, PREFDR, GATEK, DYNK, DYNXO, PRETAP, SOLO, MON.A, MON.B	*RTA source tap
/cfg/rta/rtaDecay	S		SLOW, MED, FAST	*RTA decay
/cfg/rta/rtaDet	S		PEAK, RMS, AVG	*RTA detector
/cfg/rta/rtaRange	F	30, 60		*RTA range (dB)
/cfg/rta/rtaGain	F	-5..50	56 steps	*RTA gain (dB)
/cfg/rta/rtaAuto	I	0..1		*RTA autogain
/cfg/rta/eqDecay	S		SLOW, MED, FAST	RTA eq decay
/cfg/rta/eqDet	S		PEAK, RMS, AVG	RTA eq detector
/cfg/rta/eqRange	F	30, 60		RTA eq range (dB)
/cfg/rta/eqGain	F	-5..50	56 steps	RTA eq gain (dB)
/cfg/rta/eqAuto	I	0..1		RTA eq autogain
/cfg/mtr	N			Meter config node
/cfg/mtr/\$scopesrc	I	1..76		Meter scope source [RO]

<sup>13</sup> Tags (marked with \*) are only used with metering RTA and future RTA screen, as opposed to EQ (on-screen) RTA

<sup>14</sup> See also /\$ctl/cfg/rta commands

/cfg/mtr/\$scopetap	S		IN, POST, FILT, PREEQ, POSTEQ, PREFDR, GATEK, DYNK, DYNXO, PRETAP, SOLO, MON.PH, MON.SPK, FXIN, FXOUT	Meter scope source tap point [RO]
/cfg/mtr/scopesrc	I	0..76		Meter scope source
/cfg/mtr/scopetap	S		IN, POST, FILT, PREEQ, POSTEQ, PREFDR, GATEK, DYNK, DYNXO, PRETAP, SOLO, MON.PH, MON.SPK	Meter scope source tap point
/cfg/mtr/mtrsfc	N			Meters fader node [Setup→Surface]
/cfg/mtr/mtrsfc/in	S		PRE, POST	Meters fader section channel tap
/cfg/mtr/mtrsfc/bus	S		PRE, POST	Meters fader section bus tap
/cfg/mtr/mtrsfc/main	S		PRE, POST	Meters fader section main tap
/cfg/mtr/mtrsfc/mtx	S		PRE, POST	Meters fader section matrix tap
/cfg/mtr/mtrsfc/dca	S		PRE, POST	Meters fader section DCA tap
/cfg/mtr/mtrpage	N			Meters page node (Meters screen)
/cfg/mtr/mtrpage/in	S		PRE, POST	Meters page channels tap
/cfg/mtr/mtrpage/bus	S		PRE, POST	Meters page bus tap
/cfg/mtr/mtrpage/main	S		PRE, POST	Meters page mains tap
/cfg/mtr/mtrpage/mtx	S		PRE, POST	Meters page matrix tap
/cfg/mtr/mtrpage/dca	S		PRE, POST	Meters page DCA tap
/cfg/mtr/mainmtr	S		[MAIN.1...4, MTX.1...8, MON.PH, MON.SPK, SEL_CH	Main meter
/cfg/mtr/mainpos	S		AUTO, PRE, POST	Main position
/cfg/talk	N			Talkback config node
/cfg/talk/assign	S		OFF, CH40, AUX8	Talkback assignments
/cfg/talk/\$lvl	F	-144..10	-oo..10 in 1024 steps	Talkback level (dB) [RO]
/cfg/talk/A	N			Talkback A node
/cfg/talk/A/\$on	I	0..1		Talkback A off/on
/cfg/talk/A/mode	S		AUTO, PUSH, LATCH	Talkback A mode
/cfg/talk/A/mondim	I	40..0	41 steps	Talkback A monitor dim
/cfg/talk/A/busdim	F	40..0	41 steps	Talkback A bus dim
/cfg/talk/A/indiv	I	0..1		Use individual Bus/Main TB send levels
/cfg/talk/A/B1	I	0..1		Talkback A bus 1 assign
/cfg/talk/A/B2	I	0..1		Talkback A bus 2 assign
/cfg/talk/A/B3	I	0..1		Talkback A bus 3 assign
/cfg/talk/A/B4	I	0..1		Talkback A bus 4 assign
/cfg/talk/A/B5	I	0..1		Talkback A bus 5 assign
/cfg/talk/A/B6	I	0..1		Talkback A bus 6 assign
/cfg/talk/A/B7	I	0..1		Talkback A bus 7 assign
/cfg/talk/A/B8	I	0..1		Talkback A bus 8 assign
/cfg/talk/A/B9	I	0..1		Talkback A bus 9 assign
/cfg/talk/A/B10	I	0..1		Talkback A bus 10 assign
/cfg/talk/A/B11	I	0..1		Talkback A bus 11 assign
/cfg/talk/A/B12	I	0..1		Talkback A bus 12 assign
/cfg/talk/A/B13	I	0..1		Talkback A bus 13 assign
/cfg/talk/A/B14	I	0..1		Talkback A bus 14 assign
/cfg/talk/A/B15	I	0..1		Talkback A bus 15 assign
/cfg/talk/A/B16	I	0..1		Talkback A bus 16 assign



/cfg/talk/A/MX1	I	0..1		Talkback A matrix 1 assign
/cfg/talk/A/MX2	I	0..1		Talkback A matrix 2 assign
/cfg/talk/A/MX3	I	0..1		Talkback A matrix 3 assign
/cfg/talk/A/MX4	I	0..1		Talkback A matrix 4 assign
/cfg/talk/A/MX5	I	0..1		Talkback A matrix 5 assign
/cfg/talk/A/MX6	I	0..1		Talkback A matrix 6 assign
/cfg/talk/A/MX7	I	0..1		Talkback A matrix 7 assign
/cfg/talk/A/MX8	I	0..1		Talkback A matrix 8 assign
/cfg/talk/A/M1	I	0..1		Talkback A main 1 assign
/cfg/talk/A/M2	I	0..1		Talkback A main 2 assign
/cfg/talk/A/M3	I	0..1		Talkback A main 3 assign
/cfg/talk/A/M4	I	0..1		Talkback A main 4 assign
/cfg/talk/B	N			Talkback B node
/cfg/talk/B/\$on	I	0..1		Talkback B off/on
/cfg/talk/B/mode	S		AUTO, PUSH, LATCH	Talkback B mode
/cfg/talk/B/mondim	F	40..0	41 steps	Talkback B monitor dim
/cfg/talk/B/busdim	F	40..0	41 steps	Talkback B bus dim
/cfg/talk/B/indiv	I	0..1		Use individual Bus/Main TB send levels
/cfg/talk/B/B1	I	0..1		Talkback B bus 1 assign
/cfg/talk/B/B2	I	0..1		Talkback B bus 2 assign
/cfg/talk/B/B3	I	0..1		Talkback B bus 3 assign
/cfg/talk/B/B4	I	0..1		Talkback B bus 4 assign
/cfg/talk/B/B5	I	0..1		Talkback B bus 5 assign
/cfg/talk/B/B6	I	0..1		Talkback B bus 6 assign
/cfg/talk/B/B7	I	0..1		Talkback B bus 7 assign
/cfg/talk/B/B8	I	0..1		Talkback B bus 8 assign
/cfg/talk/B/B9	I	0..1		Talkback B bus 9 assign
/cfg/talk/B/B10	I	0..1		Talkback B bus 10 assign
/cfg/talk/B/B11	I	0..1		Talkback B bus 11 assign
/cfg/talk/B/B12	I	0..1		Talkback B bus 12 assign
/cfg/talk/B/B13	I	0..1		Talkback B bus 13 assign
/cfg/talk/B/B14	I	0..1		Talkback B bus 14 assign
/cfg/talk/B/B15	I	0..1		Talkback B bus 15 assign
/cfg/talk/B/B16	I	0..1		Talkback B bus 16 assign
/cfg/talk/B/MX1	I	0..1		Talkback B matrix 1 assign
/cfg/talk/B/MX2	I	0..1		Talkback B matrix 2 assign
/cfg/talk/B/MX3	I	0..1		Talkback B matrix 3 assign
/cfg/talk/B/MX4	I	0..1		Talkback B matrix 4 assign
/cfg/talk/B/MX5	I	0..1		Talkback B matrix 5 assign
/cfg/talk/B/MX6	I	0..1		Talkback B matrix 6 assign
/cfg/talk/B/MX7	I	0..1		Talkback B matrix 7 assign
/cfg/talk/B/MX8	I	0..1		Talkback B matrix 8 assign
/cfg/talk/B/M1	I	0..1		Talkback B main 1 assign
/cfg/talk/B/M2	I	0..1		Talkback B main 2 assign
/cfg/talk/B/M3	I	0..1		Talkback B main 3 assign
/cfg/talk/B/M4	I	0..1		Talkback B main 4 assign
/cfg/amix	N			Automixing node
/cfg/amix/x	I	0..1		Automix X group enable
/cfg/amix/y	I	0..1		Automix Y group enable

## System Settings

Command	Type	Range	Text	Description
/\$syscfg	N			System configuration node
/\$syscfg/consolename	S		16 chars max	Console name
/\$syscfg/logflags	S		256 char max	Log flags
/\$syscfg/ipmode	S		DHCP, STATIC	IP Mode
/\$syscfg/ip0	I	0..255		IP first number
/\$syscfg/ip1	I	0..255		IP second number
/\$syscfg/ip2	I	0..255		IP third number
/\$syscfg/ip3	I	0..255		IP fourth number
/\$syscfg/msk0	I	0..255		IP mask first number
/\$syscfg/msk1	I	0..255		IP mask second number
/\$syscfg/msk2	I	0..255		IP mask third number
/\$syscfg/msk3	I	0..255		IP mask fourth numbe
/\$syscfg/gw0	I	0..255		IP gateway first number
/\$syscfg/gw1	I	0..255		IP gateway second number
/\$syscfg/gw2	I	0..255		IP gateway third number
/\$syscfg/gw3	I	0..255		IP gateway fourth number
/\$syscfg/\$ipapply	I	0..1		IP applied
/\$syscfg/\$firmware	S		64 chars max	Firmware version number [RO]
/\$syscfg/\$serial	S		32 chars max	Serial number [RO]
/\$syscfg/\$cncscfg	S		64 chars max	Console configuration/build type string [RO], typically start with "wing", "wing-rack", "wing-compact"
/\$syscfg/\$cncmdl	S		32 chars max	Console Model right to Console Name in Setup screen [RO], typically "ngc-full" for the full sized desk, can also be "wing-bk", "wing-rack", "wing-compact"
/\$syscfg/\$chwversion	S		32 chars max	Main board HW version [RO]
/\$syscfg/tcplock	I	0..1		Prevent modifications from TCP input
/\$syscfg/usbh_spd	S		FS, HS	USB driver speed setting Full Speed, High Speed <sup>15</sup>
/\$syscfg/\$usbspd_act	S		FS, HS	USB driver speed setting Full Speed, High Speed [RO]
/\$syscfg/eth/cfg	S		SEPARATE, SWITCHED	Optional module Ethernet mode
/\$syscfg/opt_mod	S		NONE, DANTE, WSG	Installed optional module [RO]

<sup>15</sup> When in FS, record is limited to 2 tracks/16bits. 4 tracks/24bits playing at once from USB stick may be affected; USB 3.1 capable memory sticks are recommended.

## Input/Output Settings

Command	Type	Range	Text	Description
/io	N			Input/Output node
/io/altsw	I	0..1		Main/Alt switch
/io/autoaltovr	I	0..1		Global Input Select Override
/io/in	N			Input node
/io/in/LCL	N			Local Input node
/io/in/LCL/1	N	1..24 <sup>16</sup>		Local Input 1 node
/io/in/LCL/1/mode	S		M, ST, M/S	Local Input 1 mode
/io/in/LCL/1/g	F	-3..45.5	98 steps	Local Input 1 gain (dB)
/io/in/LCL/1/vph	I	0..1		Local Input 1 phantom
/io/in/LCL/1/mute	I	0..1		Local Input 1 mute
/io/in/LCL/1/pol	I	0..1		Local Input 1 polarity
/io/in/LCL/1/col	I	1..12		Local Input 1 color
/io/in/LCL/1/name	S		16 chars max	Local Input 1 name
/io/in/LCL/1/icon	I	0..999		Local Input 1 icon (indexed)
/io/in/LCL/1/tags	S		80 chars max	Local Input 1 tags
/io/in/LCL/1/\$ha	I	0..5		Local input 1 ha type [RO]
/io/in/LCL/1/rmt	S		OFF, AES A, AES B, AES C	Local input 1 remote control
/io/in/LCL/1/\$ract	I	0..1		Local input 1 remote active [RO]
/io/in/LCL/1/\$rdest	S		7 chars max	Local input 1 remote dest [RO]
/io/in/LCL/1/rcvc	I	0..1		Local input 1 remote customizations sync
/io/in/LCL/1/\$mute	I	0..2		Local input 1 mute [RO]
/io/in/AUX	N			Aux Input node
/io/in/AUX/1	N	1..8		Aux Input 1 node
/io/in/AUX/1/mode	S		M, ST, M/S	Aux Input 1 mode
/io/in/AUX/1/mute	I	0..1		Aux Input 1 mute
/io/in/AUX/1/pol	I	0..1		Aux Input 1 polarity
/io/in/AUX/1/col	I	1..12		Aux Input 1 color
/io/in/AUX/1/name	S		16 chars max	Aux Input 1 name
/io/in/AUX/1/icon	I	0..999		Aux Input 1 icon (indexed)
/io/in/AUX/1/tags	S		80 chars max	Aux Input 1 tags
/io/in/AUX/1/\$mute	I	0..2		Aux input 1 mute [RO]
/io/in/A	N			AES50 A Input node
/io/in/A/1	N	1..48		AES50 A Input 1 node
/io/in/A/1/mode	S		M, ST, M/S	AES50 A Input 1 mode
/io/in/A/1/g	F	-3..45.5	98 steps	AES50 A Input 1 gain (dB)
/io/in/A/1/vph	I	0..1		AES50 A Input 1 phantom power
/io/in/A/1/mute	I	0..1		AES50 A Input 1 mute
/io/in/A/1/pol	I	0..1		AES50 A Input 1 polarity
/io/in/A/1/col	I	1..12		AES50 A Input 1 color
/io/in/A/1/name	S		16 chars max	AES50 A Input 1 name
/io/in/A/1/icon	I	0..999		AES50 A Input 1 icon (indexed)
/io/in/A/1/tags	S		80 chars max	AES50 A Input 1 tags
/io/in/A/1/\$ha	I	0..5		AES50 A input 1 ha type [RO]
/io/in/A/1/rmt	S		OFF, AES A, AES B, AES C	AES50 A input 1 remote control
/io/in/A/1/\$ract	I	0..1		AES50 A input 1 remote active [RO]
/io/in/A/1/\$rdest	S		7 chars max	AES50 A input 1 remote dest [RO]

<sup>16</sup> All 24 local inputs may not be available depending on the console model

/io/in/A/1/rcvc	I	0..1		AES50 A input 1 remote customizations sync
/io/in/A/1/\$mute	I	0..2		AES50 A input 1 mute [RO]
/io/in/B	N			AES50 B Input node
/io/in/B/1	N	1..48		AES50 B Input 1 node
/io/in/B/1/mode	S		M, ST, M/S	AES50 B Input 1 mode
/io/in/B/1/g	F	-3..45.5	98 steps	AES50 B Input 1 gain (dB)
/io/in/B/1/vph	I	0..1		AES50 B Input 1 phantom power
/io/in/B/1/mute	I	0..1		AES50 B Input 1 mute
/io/in/B/1/pol	I	0..1		AES50 B Input 1 polarity
/io/in/B/1/col	I	1..12		AES50 B Input 1 color
/io/in/B/1/name	S		16 chars max	AES50 B Input 1 name
/io/in/B/1/icon	I	0..999		AES50 B Input 1 icon (indexed)
/io/in/B/1/tags	S		80 chars max	AES50 B Input 1 tags
/io/in/B/1/\$ha	I	0..5		AES50 B input 1 ha type [RO]
/io/in/B/1/rmt	S		OFF, AES A, AES B, AES C	AES50 B input 1 remote control
/io/in/B/1/\$ract	I	0..1		AES50 B input 1 remote active [RO]
/io/in/B/1/\$rdest	S		7 chars max	AES50 B input 1 remote dest [RO]
/io/in/B/1/rcvc	I	0..1		AES50 B input 1 remote customizations sync
/io/in/B/1/\$mute	I	0..2		AES50 B input 1 mute [RO]
/io/in/C	N			AES50 C Input node
/io/in/C/1	N	1..48		AES50 C Input 1 node
/io/in/C/1/mode	S		M, ST, M/S	AES50 C Input 1 mode
/io/in/C/1/g	F	-3..45.5	98 steps	AES50 C Input 1 gain (dB)
/io/in/C/1/vph	I	0..1		AES50 C Input 1 phantom power
/io/in/C/1/mute	I	0..1		AES50 C Input 1 mute
/io/in/C/1/pol	I	0..1		AES50 C Input 1 polarity
/io/in/C/1/col	I	1..12		AES50 C Input 1 color
/io/in/C/1/name	S		16 chars max	AES50 C Input 1 name
/io/in/C/1/icon	I	0..999		AES50 C Input 1 icon (indexed)
/io/in/C/1/tags	S		80 chars max	AES50 C Input 1 tags
/io/in/C/1/\$ha	I	0..4		AES50 C input 1 ha type [RO]
/io/in/C/1/rmt	S		OFF, AES A, AES B, AES C	AES50 C input 1 remote control
/io/in/C/1/\$ract	I	0..1		AES50 C input 1 remote active [RO]
/io/in/C/1/\$rdest	S		7 chars max	AES50 C input 1 remote dest [RO]
/io/in/C/1/rcvc	I	0..1		AES50 C input 1 remote customizations sync
/io/in/C/1/\$mute	I	0..2		AES50 C input 1 mute [RO]
/io/in/SC	N			StageConnect Input node
/io/in/SC/1	N	1..32		StageConnect Input 1 node
/io/in/SC/1/mode	S		M, ST, M/S	StageConnect Input 1 mode
/io/in/SC/1/mute	I	0..1		StageConnect Input 1 mute
/io/in/SC/1/pol	I	0..1		StageConnect Input 1 polarity
/io/in/SC/1/col	I	1..12		StageConnect Input 1 color
/io/in/SC/1/name	S		16 chars max	StageConnect Input 1 name
/io/in/SC/1/icon	I	0..999		StageConnect Input 1 icon (indexed)
/io/in/SC/1/tags	S		80 chars max	StageConnect Input 1 tags
/io/in/SC/1/\$mute	I	0..2		StageConnect 1 mute [RO]
/io/in/USB	N			USB Input node
/io/in/USB/1	N	1..48		USB Input 1 node

/io/in/USB/1/mode	S		M, ST, M/S	USB Input 1 mode
/io/in/USB/1/mute	I	0..1		USB Input 1 mute
/io/in/USB/1/pol	I	0..1		USB Input 1 polarity
/io/in/USB/1/col	I	1..12		USB Input 1 color
/io/in/USB/1/name	S		16 chars max	USB Input 1 name
/io/in/USB/1/icon	I	0..999		USB Input 1 icon (indexed)
/io/in/USB/1/tags	S		80 chars max	USB Input 1 tags
/io/in/USB/1/\$mute	I	0..2		USB Input 1 mute [RO]
/io/in/CRD	N			Card Input node
/io/in/CRD/1	N	1..64		Card Input 1 node
/io/in/CRD/1/mode	S		M, ST, M/S	Card Input 1 mode
/io/in/CRD/1/mute	I	0..1		Card Input 1 mute
/io/in/CRD/1/pol	I	0..1		Card Input 1 polarity
/io/in/CRD/1/col	I	1..12		Card Input 1 color
/io/in/CRD/1/name	S		16 chars max	Card Input 1 name
/io/in/CRD/1/icon	I	0..999		Card Input 1 icon (indexed)
/io/in/CRD/1/tags	S		80 chars max	Card Input 1 tags
/io/in/CRD/1/\$mute	I	0..2		Card Input 1 mute [RO]
/io/in/MOD	N			Module Input node
/io/in/MOD/1	N	1..64		Module Input 1 node
/io/in/MOD/1/mode	S		M, ST, M/S	Module Input 1 mode
/io/in/MOD/1/mute	I	0..1		Module Input 1 mute
/io/in/MOD/1/pol	I	0..1		Module Input 1 polarity
/io/in/MOD/1/col	I	1..12		Module Input 1 color
/io/in/MOD/1/name	S		16 chars max	Module Input 1 name
/io/in/MOD/1/icon	I	0..999		Module Input 1 icon (indexed)
/io/in/MOD/1/tags	S		80 chars max	Module Input 1 tags
/io/in/MOD/1/\$mute	I	0..2		Module Input 1 mute [RO]
/io/in/PLAY	N			USB Player Input node
/io/in/PLAY/1	N	1..4		USB Player Input 1 node
/io/in/PLAY/1/mode	S		M, ST, M/S	USB Player Input 1 mode
/io/in/PLAY/1/mute	I	0..1		USB Player Input 1 mute
/io/in/PLAY/1/pol	I	0..1		USB Player Input 1 polarity
/io/in/PLAY/1/col	I	1..12		USB Player Input 1 color
/io/in/PLAY/1/name	S		16 chars max	USB Player Input 1 name
/io/in/PLAY/1/icon	I	0..999		USB Player Input 1 icon (indexed)
/io/in/PLAY/1/tags	S		80 chars max	USB Player Input 1 tags
/io/in/PLAY/1/\$mute	I	0..2		USB Player Input 1 mute [RO]
/io/in/AES	N			AES/EBU Input node
/io/in/AES/1	N	1..2		AES/EBU Input 1 node
/io/in/AES/1/mode	S		M, ST, M/S	AES/EBU Input 1 mode
/io/in/AES/1/mute	I	0..1		AES/EBU Input 1 mute
/io/in/AES/1/pol	I	0..1		AES/EBU Input 1 polarity
/io/in/AES/1/col	I	1..12		AES/EBU Input 1 color
/io/in/AES/1/name	S		16 chars max	AES/EBU Input 1 name
/io/in/AES/1/icon	I	0..999		AES/EBU Input 1 icon (indexed)
/io/in/AES/1/tags	S		80 chars max	AES/EBU Input 1 tags
/io/in/AES/1/\$mute	I	0..2		AES/EBU Input 1 mute [RO]
/io/in/USR	N			User Signal Input node

/io/in/USR/1	N	1..48		User Signal Input 1 node 1-24 are User Signals, 25-48 are User Patches
/io/in/USR/1/mode	S		M, ST, M/S	User Signal Input 1 mode
/io/in/USR/1/mute	I	0..1		User Signal Input 1 mute
/io/in/USR/1/pol	I	0..1		User Signal Input 1 polarity
/io/in/USR/1/col	I	1..12		User Signal Input 1 color
/io/in/USR/1/name	S		16 chars max	User Signal Input 1 name
/io/in/USR/1/icon	I	0..999		User Signal Input 1 icon (indexed)
/io/in/USR/1/tags	S		80 chars max	User Signal Input 1 tags
/io/in/USR/1/\$mute	I	0..2		User Signal Input 1 mute [RO]
/io/in/USR/1/user	N			User Signal 1 source node
/io/in/USR/1/user/grp	S		OFF, CH, AUX, BUS, MAIN, MTX	User Signal 1 source group
/io/in/USR/1/user/in	I	1..40		User Signal 1 source number
/io/in/USR/1/user/tap <sup>17</sup>	S		PRE, POST	User Signal 1 source tap point
/io/in/USR/1/user/lr <sup>18</sup>	S		L+R, L, R	User Signal 1 source take
/io/in/OSC	N			Oscillator Input node
/io/in/OSC/1	N	1..2		Oscillator Input 1 node
/io/in/OSC/1/mode	S		M, ST, M/S	Oscillator Input 1 mode [RO]
/io/in/OSC/1/mute	I	0..1		Oscillator Input 1 mute
/io/in/OSC/1/col	I	1..12		Oscillator Input 1 color
/io/in/OSC/1/name	S		16 chars max	Oscillator Input 1 name
/io/in/OSC/1/icon	I	0..999		Oscillator Input 1 icon (indexed)
/io/in/OSC/1/tags	S		80 chars max	Oscillator Input 1 tags
/io/in/OSC/1/\$mute	I	0..2		Oscillator Input 1 mute [RO]
/io/in/OSC/1/osc	N			Oscillator 1 source node
/io/in/OSC/1/osc/lvl	F	-40..6	69 steps	Oscillator 1 source level
/io/in/OSC/1/osc/mode	S		SINE, PINK, WHITE	Oscillator 1 source mode
/io/in/OSC/1/osc/f	F	20...20000	2323 steps	Oscillator 1 source frequency
/io/in/\$BUS	N			Bus Input node
/io/in/\$BUS/1	N	1..32		Bus Input 1 node
/io/in/\$BUS/1/mode	S		M, ST, M/S	Bus Input 1 mode [RO]
/io/in/\$BUS/1/col	I	1..12		Bus Input 1 color [RO]
/io/in/\$BUS/1/name	S		16 chars max	Bus Input 1 name [RO]
/io/in/\$BUS/1/icon	I	0..999		Bus Input 1 icon [RO]
/io/in/\$BUS/1/tags	S		80 chars max	Bus Input 1 tags [RO]
/io/in/\$MAIN	N			Main Input node
/io/in/\$MAIN/1	N	1..8		Main Input 1 node
/io/in/\$MAIN/1/mode	S		M, ST, M/S	Main Input 1 mode [RO]
/io/in/\$MAIN/1/col	I	1..12		Main Input 1 color [RO]
/io/in/\$MAIN/1/name	S		16 chars max	Main Input 1 name [RO]
/io/in/\$MAIN/1/icon	I	0..999		Main Input 1 icon [RO]
/io/in/\$MAIN/1/tags	S		80 chars max	Main Input 1 tags [RO]
/io/in/\$MTX	N			Matrix Input node
/io/in/\$MTX/1	N	1..16		Matrix Input 1 node
/io/in/\$MTX/1/mode	S		M, ST, M/S	Matrix Input 1 mode [RO]

<sup>17</sup> Only for nodes 1..24 [User Signals]

<sup>18</sup> Only for nodes 1..24 [User Signals]

/io/in/\$MTX/1/col	I	1..12		Matrix Input 1 color [RO]
/io/in/\$MTX/1/name	S		16 chars max	Matrix Input 1 name [RO]
/io/in/\$MTX/1/icon	I	0..999		Matrix Input 1 icon [RO]
/io/in/\$MTX/1/tags	S		80 chars max	Matrix Input 1 tags [RO]
/io/in/\$SEND	N			FX Send Input node
/io/in/\$SEND/1	N	1..32		FX Send Input 1 node
/io/in/\$SEND/1/mode	S		M, ST, M/S	FX Send Input 1 mode [RO]
/io/in/\$SEND/1/col	I	1..12		FX Send Input 1 color [RO]
/io/in/\$SEND/1/name	S		16 chars max	FX Send Input 1 name [RO]
/io/in/\$SEND/1/icon	I	0..999		FX Send Input 1 icon [RO]
/io/in/\$SEND/1/tags	S		80 chars max	FX Send Input 1 tags [RO]
/io/in/\$MON	N			Monitor Input node
/io/in/\$MON/1	N	1..4		Monitor Input 1 node
/io/in/\$MON/1/mode	S		M, ST, M/S	Monitor Input 1 mode [RO]
/io/in/\$MON/1/col	I	1..12		Monitor Input 1 color [RO]
/io/in/\$MON/1/name	S		16 chars max	Monitor Input 1 name [RO]
/io/in/\$MON/1/icon	I	0..999		Monitor Input 1 icon [RO]
/io/in/\$MON/1/tags	S		80 chars max	Monitor Input 1 tags [RO]
/io/out	N			Output node
/io/out/LCL	N			Local Output node
/io/out/LCL/1	N	1..8		Local Output 1 node
/io/out/LCL/1/grp	S		OFF, LCL, AUX, A, B, C, SC, USB, CRD, MOD, PLAY, AES, USR, OSC, BUS, MAIN, MTX, SEND, MON	Local Output 1 group
/io/out/LCL/1/in	I	1..64		Local Output 1 input
/io/out/AUX	N			Aux Output node
/io/out/AUX/1	N	1..8 <sup>19</sup>		Aux Output 1 node
/io/out/AUX/1/grp	S		OFF, LCL, AUX, A, B, C, SC, USB, CRD, MOD, PLAY, AES, USR, OSC, BUS, MAIN, MTX, SEND, MON	Aux Output 1 group
/io/out/AUX/1/in	I	1..64		Aux Output 1 input
/io/out/A	N			AES50 A Output node
/io/out/A/1	N	1..48		AES50 A Output 1 node
/io/out/A/1/grp	S		OFF, LCL, AUX, A, B, C, SC, USB, CRD, MOD, PLAY, AES, USR, OSC, BUS, MAIN, MTX, SEND, MON	AES50 A Output 1 group
/io/out/A/1/in	I	1..64		AES50 A Output 1 input
/io/out/B	N			AES50 B Output node
/io/out/B/1	N	1..48		AES50 B Output 1 node
/io/out/B/1/grp	S		OFF, LCL, AUX, A, B, C, SC, USB, CRD, MOD, PLAY, AES, USR, OSC, BUS, MAIN, MTX, SEND, MON	AES50 B Output 1 group
/io/out/B/1/in	I	1..64		AES50 B Output 1 input
/io/out/C	N			AES50 C Output node
/io/out/C/1	N	1..48		AES50 C Output 1 node

<sup>19</sup> Aux 1..6 may be 'not available' on some models

/io/out/C/1/grp	S		OFF, LCL, AUX, A, B, C, SC, USB, CRD, MOD, PLAY, AES, USR, OSC, BUS, MAIN, MTX, SEND, MON	AES50 C Output 1 group
/io/out/C/1/in	I	1..64		AES50 C Output 1 input
/io/out/SC	N			StageConnect Output node
/io/out/SC/1	N	1..32		StageConnect Output 1 node
/io/out/SC/1/grp	S		OFF, LCL, AUX, A, B, C, SC, USB, CRD, MOD, PLAY, AES, USR, OSC, BUS, MAIN, MTX, SEND, MON	StageConnect Output 1 group
/io/out/SC/1/in	I	1..64		StageConnect Output 1 input
/io/out/USB	N			USB Output Audio node
/io/out/USB/1	N	1..48		USB Output Audio 1 node
/io/out/USB/1/grp	S		OFF, LCL, AUX, A, B, C, SC, USB, CRD, MOD, PLAY, AES, USR, OSC, BUS, MAIN, MTX, SEND, MON	USB Output Audio 1 group
/io/out/USB/1/in	I	1..64		USB Output Audio 1 input
/io/out/CRD	N			Card Output node
/io/out/CRD/1	N	1..64		Card Output 1 node
/io/out/CRD/1/grp	S		OFF, LCL, AUX, A, B, C, SC, USB, CRD, MOD, PLAY, AES, USR, OSC, BUS, MAIN, MTX, SEND, MON	Card Output 1 group
/io/out/CRD/1/in	I	1..64		Card Output 1 input
/io/out/MOD	N			Module Output node
/io/out/MOD/1	N	1..64		Module Output 1 node
/io/out/MOD/1/grp	S		OFF, LCL, AUX, A, B, C, SC, USB, CRD, MOD, PLAY, AES, USR, OSC, BUS, MAIN, MTX, SEND, MON	Module Output 1 group
/io/out/MOD/1/in	I	1..64		Module Output 1 input
/io/out/REC	N			USB Record Output node
/io/out/REC/1	N	1..4		USB Record Output 1 node
/io/out/REC/1/grp	S		OFF, LCL, AUX, A, B, C, SC, USB, CRD, MOD, PLAY, AES, USR, OSC, BUS, MAIN, MTX, SEND, MON	USB Record Output 1 group
/io/out/REC/1/in	I	1..64		USB Record Output 1 input
/io/out/AES	N			AES/EBU Output node
/io/out/AES/1	N	1..2		AES/EBU Output 1 node
/io/out/AES/1/grp	S		OFF, LCL, AUX, A, B, C, SC, USB, CRD, MOD, PLAY, AES, USR, OSC, BUS, MAIN, MTX, SEND, MON	AES/EBU Output 1 group
/io/out/AES/1/in	I	1..64		AES/EBU Output 1 input



## Channel Settings

Command	Type	Range	Text	Description
/ch	N			Channel node
/ch/1	N	1..40		Channel 1 node
/ch/1/in	N			Channel 1 input node
/ch/1/in/set	N			Channel 1 input set node
/ch/1/in/set/\$mode	S		M, ST, M/S	Channel 1 input mode [RO]
/ch/1/in/set/srcauto	I	0..1		Channel 1 input auto source switch
/ch/1/in/set/altsrc	I	0..1		Channel 1 input main/alt switch
/ch/1/in/set/inv	I	0..1		Channel 1 input phase invert switch
/ch/1/in/set/trim	F	-18..18	361 steps	Channel 1 input trim (dB)
/ch/1/in/set/bal	F	-9..9	181 steps	Channel 1 input balance (dB)
/ch/1/in/set/\$g	F	-2.5..45 -3.0..45.5	20 steps (LCL) 98 steps (AES)	Channel 1 input gain (dB) – depends on source type
/ch/1/in/set/\$vph	I	0..1		Channel 1 input phantom power – depends on source type
/ch/1/in/set/dlymode	S		M, FT, MS, SMP	Meters, feet, milliseconds, samples
/ch/1/in/set/dly	F	0..150 m / 0.5..500 ft / 0.5..500 ms / / 16..500 smp	1501 steps / 1000 steps / 4996 steps / 485 steps	Channel 1 input delay (meters, feet, ms, samples)
/ch/1/in/set/dlyon	I	0..1		Channel 1 input delay
/ch/1/in/conn	N			Channel 1 input connection node
/ch/1/in/conn/grp	S		OFF, LCL, AUX, A, B, C, SC, USB, CRD, MOD, PLAY, AES, USR, OSC, BUS, MAIN, MTX	Channel 1 main input connection group
/ch/1/in/conn/in	I	1..64		Channel 1 main input connection group index
/ch/1/in/conn/altgrp	S		OFF, LCL, AUX, A, B, C, SC, USB, CRD, MOD, PLAY, AES, USR, OSC, BUS, MAIN, MTX	Channel 1 alt input connection group
/ch/1/in/conn/altin	I	1..64		Channel 1 alt input connection group index
/ch/1/flt	N			Channel 1 filter node
/ch/1/flt/lc	I	0..1		Channel 1 low cut switch
/ch/1/flt/lcf	F	20..2000	641 steps	Channel 1 low cut frequency (Hz)
/ch/1/flt/lcs	S		6, 12, 18, 24	Channel 1 low cut slope
/ch/1/flt/hc	I	0..1		Channel 1 high cut switch
/ch/1/flt/hcf	F	50..20000	833 steps	Channel 1 high cut frequency (Hz)
/ch/1/flt/hcs	S		6, 12	Channel 1 high cut slope
/ch/1/flt/tf	I	0..1		Channel 1 tool filter switch
/ch/1/flt/mdl	S		TILT, MAX, AP1, AP2	Channel 1 filter model (see Appendix on Filter plugins for parameters details, OSC patterns in italic below correspond to TILT)
/ch/1/flt/ <i>tilt</i> <sup>20</sup>	F	-6..6	49 steps	Channel 1 tilt level (dB)
/ch/1/clink	I	0..1		Channel 1 custom link
/ch/1/col	I	1..12		Channel 1 color

<sup>20</sup> This is for the TILT filter model. Can use more parameters depending on model type

/ch/1/name	S		16 chars max	Channel 1 name
/ch/1/icon	I	0..999		Channel 1 icon
/ch/1/led	I	0..1		Channel 1 scribble light
/ch/1/\$col	I	1..12		Channel 1 color [RO] reflects linked source or current strip value
/ch/1/\$name	S		16 chars max	Channel 1 name [RO] reflects linked source or current strip value
/ch/1/\$icon	I	0..999		Channel 1 icon [RO] reflects linked source or current strip value
/ch/1/mute	I	0..1		Channel 1 mute
/ch/1/fdr	F	-144..10	-oo..10 in 1024 steps	Channel 1 fader
/ch/1/pan	F	-100..100	201 steps	Channel 1 pan
/ch/1/wid	F	-150..150	61 steps	Channel 1 width (%)
/ch/1/\$solo	I	0..1		Channel 1 solo switch
/ch/1/\$sololed	I	0..2		Channel 1 solo LED [RO]
/ch/1/solosafe	I	0..1		Channel 1 solo safe
/ch/1/mon	S		A, B, A+B	Channel 1 monitor mode
/ch/1/proc	S		GEDI, GEID, GIED, IGED, GDEI, GDIE, GIDE, IGDE, EGDI, EGID, EIGD, IEGD, EDGI, EDIG, EIDG, IEDG, DEGI, DEIG, DIEG, IDEG, DGEI, DGIE, DIGE, IDGE	Channel 1 process order (G: gate, E: EQ, D: Dynamics, I: Insert)
/ch/1/ptap	S		IN, FILT, 3, 4, 5, PFL, AFL, POST	Channel 1 pretap (to sends)
/ch/1/\$presolo	I	0..1		Channel 1 presolo
/ch/1/peq	N			Channel 1 PreSend EQ node
/ch/1/peq/on	I	0..1		Channel 1 PEQ switch
/ch/1/peq/1g	F	-15..15	301 steps	Channel 1 PEQ band 1 gain (dB)
/ch/1/peq/1f	F	20..20000	960 steps	Channel 1 PEQ band 1 frequency (Hz)
/ch/1/peq/1q	F	0.44..10	181 steps	Channel 1 PEQ band 1 Q
/ch/1/peq/2g	F	-15..15	301 steps	Channel 1 PEQ band 2 gain 9dB
/ch/1/peq/2f	F	20..20000	960 steps	Channel 1 PEQ band 2 frequency (Hz)
/ch/1/peq/2q	F	0.44..10	181 steps	Channel 1 PEQ band 2 Q
/ch/1/peq/3g	F	-15..15	301 steps	Channel 1 PEQ band 3 gain 9dB
/ch/1/peq/3f	F	20..20000	960 steps	Channel 1 PEQ band 3 frequency (Hz)
/ch/1/peq/3q	F	0.44..10	181 steps	Channel 1 PEQ band 3 Q
/ch/1/gate	N			Channel 1 gate node
/ch/1/gate/on	I	0..1		Channel 1 gate switch
/ch/1/gate/mdl	S		GATE, DUCK, E88, 9000G, D241, DS902, WAVE, DEQ, WARM, 76LA, LA, RIDE, PSE, CMB	Channel 1 gate model (see Appendix on Gate plugins for parameters details, OSC patterns in italic below correspond to GATE)
/ch/1/gate/thr <sup>21</sup>	F	-80..0	161 steps	Channel 1 gate threshold (dB)
/ch/1/gate/range	F	3..60	115 steps	Channel 1 gate range (dB)
/ch/1/gate/att	F	0..120	121 steps	Channel 1 gate attack (ms)
/ch/1/gate/hld	F	0..200	200 steps	Channel 1 gate hold (ms)
/ch/1/gate/rel	F	4..4000	130 steps	Channel 1 gate release(ms)
/ch/1/gate/acc	F	0..100	21 steps	Channel 1 gate accent (5)
/ch/1/gate/ratio	S		1:1.5, 1:2, 1:3, 1:4, GATE	Channel 1 gate ratio

<sup>21</sup> This is for the GATE gate model. Can use more parameters depending on model type

/ch/1/gatesc	N			Channel 1 gate sidechain node
/ch/1/gatesc/type	S		Off, LP12, HP12, BP	Channel 1 gate sidechain type
/ch/1/gatesc/f	F	20..20000	961 steps	Channel 1 gate sidechain frequency (Hz)
/ch/1/gatesc/q	F	0.44..10	181 steps	Channel 1 gate sidechain Q
/ch/1/gatesc/src	S		SHELF, Ch.1..Ch.40	Channel 1 gate sidechain source
/ch/1/gatesc/tap	S		IN, FILT, 3, 4, 5, PFL, AFL, POST	Channel 1 gate sidechain tap
/ch/1/gatesc/\$solo	I	0..1		Channel 1 gate sidechain solo
/ch/1/eq	N			Channel 1 EQ node
/ch/1/eq/on	I	0..1		Channel 1 EQ switch
/ch/1/eq/mdl	S		STD, SOUL, E88, E84, F110, PULSAR, MACH4	Channel 1 EQ model (see Appendix on EQ plugins for parameters details, OSC patterns in italic below correspond to STD)
/ch/1/eq/mix	F	0..125	126 steps	Channel 1 EQ mix (%)
/ch/1/eq/\$solo	I	0..1		Channel 1 EQ solo
/ch/1/eq/\$solobd	I	0..6		Channel 1 EQ solo band
/ch/1/eq/lg <sup>22</sup>	F	-15..15	301 steps	Channel 1 EQ low gain (dB)
/ch/1/eq/lf	F	20..2000	641 steps	Channel 1 EQ low frequency (Hz)
/ch/1/eq/lq	F	0.44..10	181 steps	Channel 1 EQ low Q
/ch/1/eq/leq	S		PEQ, SHV	Channel 1 EQ low type
/ch/1/eq/1g	F	-15..15	301 steps	Channel 1 EQ band 1 gain (dB)
/ch/1/eq/1f	F	20..20000	961 steps	Channel 1 EQ band 1 frequency (Hz)
/ch/1/eq/1q	F	0.44..10	181 steps	Channel 1 EQ band 1 Q
/ch/1/eq/2g	F	-15..15	301 steps	Channel 1 EQ band 2 gain (dB)
/ch/1/eq/2f	F	20..20000	961 steps	Channel 1 EQ band 2 frequency (Hz)
/ch/1/eq/2q	F	0.44..10	181 steps	Channel 1 EQ band 2 Q
/ch/1/eq/3g	F	-15..15	301 steps	Channel 1 EQ band 3 gain (dB)
/ch/1/eq/3f	F	20..20000	961 steps	Channel 1 EQ band 3 frequency (Hz)
/ch/1/eq/3q	F	0.44..10	181 steps	Channel 1 EQ band 3 Q
/ch/1/eq/4g	F	-15..15	301 steps	Channel 1 EQ band 4 gain (dB)
/ch/1/eq/4f	F	20..20000	961 steps	Channel 1 EQ band 4 frequency (Hz)
/ch/1/eq/4q	F	0.44..10	181 steps	Channel 1 EQ band 4 Q
/ch/1/eq/hg	F	-15..15	301 steps	Channel 1 EQ high gain (dB)
/ch/1/eq/hf	F	50..20000	833 steps	Channel 1 EQ high frequency (Hz)
/ch/1/eq/hq	F	0.44..10	181 steps	Channel 1 EQ high Q
/ch/1/eq/heq	S		SHV, PEQ	Channel 1 EQ high type
/ch/1/dyn	N			Channel 1 dynamic (compressor) node
/ch/1/dyn/on	I	0..1		Channel 1 compressor switch
/ch/1/dyn/mdl	S		COMP, EXP, B160, B560, D241, ECL33, 9000C, SBUS, RED3, 76LA, LA, F670, BLISS, NSTR, WAVE, RIDE, 2250, L100, CMB <sup>23</sup>	Channel 1 compressor model (see Appendix on Compressor plugins for parameters details, OSC patterns in italic below correspond to COMP)
/ch/1/dyn/mix	F	0..100	101 steps	Channel 1 compressor mix (%)
/ch/1/dyn/gain	F	-6..12	37 steps	Channel 1 compressor gain (dB)
/ch/1/dyn/thr <sup>24</sup>	F	-60..0	121 steps	Channel 1 compressor threshold (dB)

<sup>22</sup> This is for the STD eq model. Can use more parameters depending on model type

<sup>23</sup> Side chain EQ is not available when auxcombo [CMB] is used in dyn slot

<sup>24</sup> This is for the COMP dyn model. Can use more parameters depending on model type

/ch/1/dyn/ratio	S		1.1, 1.2, 1.3, 1.5, 1.7, 2.0, 2.5, 3.0, 3.5, 4.0, 5.0, 6.0, 8.0, 10, 20, 50, 100	Channel 1 compressor ratio
/ch/1/dyn/knee	I	0..5		Channel 1 compressor knee
/ch/1/dyn/det	S		PEAK, RMS	Channel 1 compressor detect
/ch/1/dyn/att	F	0..120	121 steps	Channel 1 compressor attack (ms)
/ch/1/dyn/hld	F	1..200	200 steps	Channel 1 compressor hold (ms)
/ch/1/dyn/rel	F	4..4000	130 steps	Channel 1 compressor release (ms)
/ch/1/dyn/env	S		LIN, LOG	Channel 1 compressor envelope
/ch/1/dyn/auto	I	0..1		Channel 1 compressor auto switch
/ch/1/dynxo	N			Channel 1 compressor crossover node
/ch/1/dynxo/depth	F	0..20	41 steps	Channel 1 compressor crossover depth (dB)
/ch/1/dynxo/type	S		OFF, LO6, LO12, HI6, HI12, PC	Channel 1 compressor crossover type
/ch/1/dynxo/f	F	20..20000	901 steps	Channel 1 compressor crossover frequency (Hz)
/ch/1/dynxo/\$solo	I	0..1		Channel 1 compressor crossover solo
/ch/1/dynsc	N			Channel 1 compressor sidechain node
/ch/1/dynsc/type	S		Off, LP12, HP12, BP	Channel 1 compressor sidechain type
/ch/1/dynsc/f	F	20..20000	901 steps	Channel 1 compressor sidechain frequency (Hz)
/ch/1/dynsc/q	F	0.44..10	181 steps	Channel 1 compressor sidechain Q
/ch/1/dynsc/src	S		SELF, CH.1..CH.40	Channel 1 compressor sidechain source
/ch/1/dynsc/tap	S		IN, FILT, 3, 4, 5, PFL, AFL, POST	Channel 1 compressor sidechain tap
/ch/1/dynsc/\$solo	I	0..1		Channel 1 compressor sidechain solo
/ch/1/preins	N			Channel 1 pre-insert node
/ch/1/preins/on	I	0..1		Channel 1 pre-insert switch
/ch/1/preins/ins	S		NONE, FX1..FX16	Channel 1 pre-insert FX slot
/ch/1/preins/\$stat	S		-, OK, N/A	Channel 1 pre-insert status [RO]
/ch/1/main	N			Channel 1 Main node
/ch/1/main/1	N	1..4 <sup>25</sup>		Channel 1 Main 1 node
/ch/1/main/1/on	I	0..1		Channel 1 Main 1 on switch
/ch/1/main/1/lvl	F	-144..10	-oo..10 in 1024 steps	Channel 1 Main 1 fader level (dB)
/ch/1/main/pre	I	0..1		Channel 1 sent pre fader to Main 1
/ch/1/send	N			Channel 1 sends node
/ch/1/send/1	N	1..16		Channel 1 sends 1 node
/ch/1/send/1/on	I	0..1		Channel 1 sends 1 on switch
/ch/1/send/1/lvl	F	-144..10	-oo..10 in 1024 steps	Channel 1 sends 1 fader level (dB)
/ch/1/send/1/pon	I	0..1		Channel 1 sends 1 pre always on switch
/ch/1/send/1/mode	S		PRE, POST, GRP	Channel 1 sends 1 mode
/ch/1/send/1/plink	I	0..1		Channel 1 sends 1 pan link (0=individual)
/ch/1/send/1/pan	F	-100..100	201 steps	Channel 1 sends 1 pan
/ch/1/send/MX<x>	N	<x>:1..8		Channel 1 sends matrix <x> node
/ch/1/send/MX<x>/on	I	0..1		Channel 1 sends mtX on switch

<sup>25</sup> 1..8 on WING Rack model, used for the 4 headphones stereo outputs on the back on the rack.

/ch/1/send/MX<x>/lvl	F	-144..10	-oo..10 in 1024 steps	Channel 1 sends mtX fader level (dB)
/ch/1/send/MX<x>/pon	I	0..1		Channel 1 sends mtX pre always on switch
/ch/1/send/MX<x>/mode	S		PRE, POST, GRP	Channel 1 sends mtX mode
/ch/1/send/MX<x>/plink	I	0..1		Channel 1 sends mtX pan link (0=individual)
/ch/1/send/MX<x>/pan	F	-100..100	201 steps	Channel 1 sends mtX pan
/ch/1/tapwid	F	-150..150		Channel 1 width
/ch/1/postins	N			Channel 1 post insert node
/ch/1/postins/on	I	0..1		Channel 1 post insert on switch
/ch/1/postins/mode	S		FX, AUTO_X, AUTO_Y	Channel 1 post insert mode
/ch/1/postins/ins	S		NONE, FX1..FX16	Channel 1 post insert FX slot
/ch/1/postins/w	F	-12..12	241 steps	Channel 1 post insert autogain weight
/ch/1/postins/\$stat	S		-, OK, N/A	Channel 1 post insert status [RO]
/ch/1/tags	S		80 chars max	Channel 1 tags <sup>26</sup>
/ch/1/\$fdr	F	-144..10	-oo..10 in 1024 steps	Channel 1 fader level as affected by dca (dB) [RO]
/ch/1/\$mute	I	0..2		Channel 1 mute [RO]
/ch/1/\$muteovr	I	0..1		Channel 1 mute override

<sup>26</sup> Tags #D1..#D16 are 'reserved' for DCA1..16 assignment

## Aux Settings

Command	Type	Range	Text	Description
/aux	N			Aux node
/aux/1	N	1..8		Aux 1 node
/aux/1/in	N			Aux 1 input node
/aux/1/in/set	N			Aux 1 input set node
/aux/1/in/set/\$mode	S		M, ST, M/S	Aux 1 input mode [RO]
/aux/1/in/set/srcauto	I	0..1		Aux 1 input auto source switch
/aux/1/in/set/altsrc	I	0..1		Aux 1 input main/alt switch
/aux/1/in/set/inv	I	0..1		Aux 1 input phase invert switch
/aux/1/in/set/trim	F	-18..18	361 steps	Aux 1 input trim (dB)
/aux/1/in/set/bal	F	-9..9	181 steps	Aux 1 input balance (dB)
/aux/1/in/set/\$g	F	-3..45	98 steps	Aux 1 input gain (dB)
/aux/1/in/set/\$vph	I	0..1		Aux 1 input phantom power
/aux/1/in/set/dlymode	S		M, FT, MS, SMP	Meters, feet, milliseconds, samples
/aux/1/in/set/dly	F	0..150 m / 0.5..500 ft / 0.5..500 ms / 16..500 smp	1501 steps / 1000 steps / 4996 steps / 485 steps	Aux 1 input delay (meters, feet, ms, samples)
/aux/1/in/set/dlyon	I	0..1		Aux 1 input delay
/aux/1/in/conn	N			Aux 1 input connection node
/aux/1/in/conn/grp	S		OFF, LCL, AUX, A, B, C, SC, USB, CRD, MOD, PLAY, AES, USR, OSC, BUS, MAIN, MTX	Aux 1 input connection group
/aux/1/in/conn/in	I	1..64		Aux 1 input connection group index
/aux/1/in/conn/altgrp	S		OFF, LCL, AUX, A, B, C, SC, USB, CRD, MOD, PLAY, AES, USR, OSC, BUS, MAIN, MTX	Aux 1 alt input connection group
/aux/1/in/conn/altin	I	1..64		Aux 1 alt input connection group index
/aux/1/clink	I	0..1		Aux 1 custom link
/aux/1/col	I	1..12		Aux 1 color
/aux/1/name	S		16 chars max	Aux 1 name
/aux/1/icon	I	0..999		Aux 1 icon
/aux/1/led	I	0..1		Aux 1 scribble light
/aux/1/\$col	I	1..12		Aux 1 color [RO] reflects linked source or current strip value
/aux/1/\$name	S		16 chars max	Aux 1 name [RO] reflects linked source or current strip value
/aux/1/\$icon	I	0..999		Aux 1 icon [RO] reflects linked source or current strip value
/aux/1/mute	I	0..1		Aux 1 mute
/aux/1/fdr	F	-144..10	-oo..10 in 1024 steps	Aux 1 fader level (dB)
/aux/1/pan	F	-100..100	201 steps	Aux 1 pan
/aux/1/wid	F	-150..150	61 steps	Aux 1 width (%)
/aux/1/\$solo	I	0..1		Aux 1 solo
/aux/1/\$sololed	I	0..2		Aux 1 solo LED [RO]
/aux/1/solosafe	I	0..1		Aux 1 solo safe
/aux/1/mon	S		A, B, A+B	Aux 1 monitor mode
/aux/1/eq	N			Aux 1 EQ node
/aux/1/eq/on	I	0..1		Aux 1 EQ switch

/aux/1/eq/mdl	S		STD, SOUL, E88, E84, F110, PULSAR	Aux 1 EQ model (see Appendix on EQ plugins for parameters details, OSC patterns in italic below correspond to STD)
/aux/1/eq/mix	F	0..125	126 steps	Aux 1 EQ mix (%)
/aux/1/eq/\$solo	I	0..1		Aux 1 EQ solo
/aux/1/eq/\$solobd	I	0..6		Aux 1 EQ solo band
/aux/1/eq/lg <sup>27</sup>	F	-15..15	301 steps	Aux 1 EQ low gain (dB)
/aux/1/eq/lf	F	20..2000	641 steps	Aux 1 EQ low frequency (Hz)
/aux/1/eq/lq	F	0.44..10	181 steps	Aux 1 EQ low Q
/aux/1/eq/leq	S		SHV, PEQ, CUT	Aux 1 EQ low type
/aux/1/eq/1g	F	-15..15	301 steps	Aux 1 EQ band 1 gain (dB)
/aux/1/eq/1f	F	20..20000	961 steps	Aux 1 EQ band 1 frequency (Hz)
/aux/1/eq/1q	F	0.44..10	181 steps	Aux 1 EQ band 1 Q
/aux/1/eq/2g	F	-15..15	301 steps	Aux 1 EQ band 2 gain (dB)
/aux/1/eq/2f	F	20..20000	961 steps	Aux 1 EQ band 2 frequency (Hz)
/aux/1/eq/2q	F	0.44..10	181 steps	Aux 1 EQ band 2 Q
/aux/1/eq/3g	F	-15..15	301 steps	Aux 1 EQ band 3 gain (dB)
/aux/1/eq/3f	F	20..20000	961 steps	Aux 1 EQ band 3 frequency (Hz)
/aux/1/eq/3q	F	0.44..10	181 steps	Aux 1 EQ band 3 Q
/aux/1/eq/4g	F	-15..15	301 steps	Aux 1 EQ band 4 gain (dB)
/aux/1/eq/4f	F	20..20000	961 steps	Aux 1 EQ band 4 frequency (Hz)
/aux/1/eq/4q	F	0.44..10	181 steps	Aux 1 EQ band 4 Q
/aux/1/eq/hg	F	-15..15	301 steps	Aux 1 EQ high gain (dB)
/aux/1/eq/hf	F	50..20000	833 steps	Aux 1 EQ high frequency (Hz)
/aux/1/eq/hq	F	0.44..10	181 steps	Aux 1 EQ high Q
/aux/1/eq/heq	S		SHV, PEQ, CUT	Aux 1 EQ high type
/aux/1/dyn	N			Aux 1 dynamic (PSE/LA combo) node
/aux/1/dyn/on	I	0..1		Aux 1 compressor switch
/aux/1/dyn/thr	F	-36..12	97 steps	Aux 1 compressor threshold (dB)
/aux/1/dyn/depth	F	0..20	41 steps	Aux 1 compressor depth (dB)
/aux/1/dyn/fast	I	0..1		Aux 1 compressor fast switch
/aux/1/dyn/peak	I	0..1		Aux 1 compressor peak switch
/aux/1/dyn/ingain	F	0..100	101 steps	Aux 1 compressor input gain
/aux/1/dyn/cpeak	F	0..100	101 steps	Aux 1 compressor peak
/aux/1/dyn/cmode	S		COMP, LIM	Aux 1 compressor mode
/aux/1/preins	N			Aux 1 pre-insert node
/aux/1/preins/on	I	0..1		Aux 1 pre-insert switch
/aux/1/preins/ins	S		NONE, FX1..FX16	Aux 1 pre-insert FX slot
/aux/1/preins/\$stat	S		-, OK, N/A	Aux 1 pre-insert status [RO]
/aux/1/main	N			Aux 1 Main node
/aux/1/main/1	N	1..4		Aux 1 Main 1 node
/aux/1/main/1/on	I	0..1		Aux 1 Main 1 on switch
/aux/1/main/1/lvl	F	-144..10	-oo..10 in 1024 steps	Aux 1 Main 1 fader level (dB)
/aux/1/main/1/pre	I	0..1		Aux 1 sent pre fader to Main 1
/aux/1/send	N			Aux 1 sends node
/aux/1/send/1	N	1..16		Aux 1 sends 1 node
/aux/1/send/1/on	I	0..1		Aux 1 sends 1 on switch

<sup>27</sup> This is for the STD eq model. Can use more parameters depending on model type

/aux/1/send/1/lvl	F	-144..10	-oo..10 in 1024 steps	Aux 1 sends 1 fader level (dB)
/aux/1/send/1/pon	I	0..1		Aux 1 sends 1 pre always on switch
/aux/1/send/1/mode	S		PRE, POST, GRP	Aux 1 sends 1 mode
/aux/1/send/1/plink	I	0..1		Aux 1 sends 1 pan link (0=individual)
/aux/1/send/1/pan	F	-100..100	201 steps	Aux 1 sends 1 pan
/aux/1/send/MX<x>	N	<x>:1..8		Aux 1 sends matrix <x> node
/aux/1/send/MX<x>/on	I	0..1		Aux 1 sends mtX on switch
/aux/1/send/MX<x>/lvl	F	-144..10	-oo..10 in 1024 steps	Aux 1 sends mtX fader level (dB)
/aux/1/send/MX<x>/pon	I	0..1		Aux 1 sends mtX pre always on switch
/aux/1/send/MX<x>/mode	S		PRE, POST, GRP	Aux 1 sends mtX mode
/aux/1/send/MX<x>/plink	I	0..1		Aux 1 sends mtX pan link (0=individual)
/aux/1/send/MX<x>/pan	F	-100..100	201 steps	Aux 1 sends mtX pan
/aux/1/tags	S	80 chars max		Aux 1 tags <sup>28</sup>
/aux/1/\$fdr	F	-144..10	-oo..10 in 1024 steps	Aux 1 fader level as affected by dca (dB)[RO]
/aux/1/\$mute	I	0..2		Aux 1 mute {RO}
/aux/1/\$muteovr	I	0..1		Aux 1 mute override

<sup>28</sup> Tags #D1..#D16 are 'reserved' for DCA1..16 assignment



## Bus Settings

Command	Type	Range	Text	Description
/bus	N			Bus node
/bus/1	N	1..16		Bus 1 node
/bus/1/in	N			Bus 1 input node
/bus/1/in/set	N			Bus 1 input set node
/bus/1/in/set/inv	I	0..1		Bus 1 input phase invert
/bus/1/in/set/trim	F	-18..18	361 steps	Bus 1 input trim (dB)
/bus/1/in/set/bal	F	-9..9	181 steps	Bus 1 input balance (dB)
/bus/1/col	I	1..12		Bus 1 color
/bus/1/name	S		16 chars max	Bus 1 name
/bus/1/icon	I	0..999		Bus 1 icon
/bus/1/led	I	0..1		Bus 1 scribble light
/bus/1/\$col	I	1..12		Bus 1 color [RO] reflects linked source or current strip value
/bus/1/\$name	S		16 chars max	Bus 1 name [RO] reflects linked source or current strip value
/bus/1/\$icon	I	0..999		Bus 1 icon [RO] reflects linked source or current strip value
/bus/1/busmono	I	0..1		Bus 1 mono switch
/bus/1/mute	I	0..1		Bus 1 mute
/bus/1/fdr	F	-144..10	-∞..10 in 1024 steps	Bus 1 fader level (dB)
/bus/1/pan	F	-100..100	201 steps	Bus 1 pan
/bus/1/wid	F	-150..150	61 steps	Bus 1 width (%)
/bus/1/\$solo	I	0..1		Bus 1 solo
/bus/1/\$sololed	I	0..2		Bus 1 solo LED {RO}
/bus/1/mon	S		A, B, A+B	Bus 1 monitor mode
/bus/1/eq	N			Bus 1 EQ node
/bus/1/eq/on	I	0..1		Bus 1 EQ on switch
/bus/1/eq/mdl	S		STD, SOUL, E88, E84, F110, PULSAR, PIA	Bus 1 EQ model (see Appendix on EQ plugins for parameters details, OSC patterns in italic below correspond to STD)
/bus/1/eq/mix	F	0..100	126 steps	Bus 1 EQ mix
/bus/1/eq/\$solo	I	0..1		Bus 1 EQ solo
/bus/1/eq/\$solobd	I	0..1		Bus 1 EQ band solo
/bus/1/eq/l <sup>g</sup> <sup>29</sup>	F	-15..15	301 steps	Bus 1 EQ low gain (dB)
/bus/1/eq/lf	F	20..2000	641 steps	Bus 1 EQ low frequency (Hz)
/bus/1/eq/lq	F	0.44..10	181 steps	Bus 1 EQ low Q
/bus/1/eq/leq	S		PEQ, SHV, CUT, BW6, BW12, BS12, LR12, BW18, BW24, BS24, LR24, BW48, LR48	Bus 1 EQ low type
/bus/1/eq/1g	F	-15..15	301 steps	Bus 1 EQ band 1 gain (dB)
/bus/1/eq/1f	F	20..20000	961 steps	Bus 1 EQ band 1 frequency (Hz)
/bus/1/eq/1q	F	0.44..10	181 steps	Bus 1 EQ band 1 Q
/bus/1/eq/2g	F	-15..15	301 steps	Bus 1 EQ band 2 gain (dB)
/bus/1/eq/2f	F	20..20000	961 steps	Bus 1 EQ band 2 frequency (Hz)
/bus/1/eq/2q	F	0.44..10	181 steps	Bus 1 EQ band 2 Q
/bus/1/eq/3g	F	-15..15	301 steps	Bus 1 EQ band 3 gain (dB)
/bus/1/eq/3f	F	20..20000	961 steps	Bus 1 EQ band 3 frequency (Hz)
/bus/1/eq/3q	F	0.44..10	181 steps	Bus 1 EQ band 3 Q

<sup>29</sup> This is for the STD eq model. Can use more parameters depending on model type

/bus/1/eq/4g	F	-15..15	301 steps	Bus 1 EQ band 4 gain (dB)
/bus/1/eq/4f	F	20..20000	961 steps	Bus 1 EQ band 4 frequency (Hz)
/bus/1/eq/4q	F	0.44..10	181 steps	Bus 1 EQ band 4 Q
/bus/1/eq/5g	F	-15..15	301 steps	Bus 1 EQ band 5 gain (dB)
/bus/1/eq/5f	F	20..20000	961 steps	Bus 1 EQ band 5 frequency (Hz)
/bus/1/eq/5q	F	0.44..10	181 steps	Bus 1 EQ band 5 Q
/bus/1/eq/6g	F	-15..15	301 steps	Bus 1 EQ band 6 gain (dB)
/bus/1/eq/6f	F	20..20000	961 steps	Bus 1 EQ band 6 frequency (Hz)
/bus/1/eq/6q	F	0.44..10	181 steps	Bus 1 EQ band 6 Q
/bus/1/eq/hg	F	-15..15	301 steps	Bus 1 EQ high gain (dB)
/bus/1/eq/hf	F	50..20000	833 steps	Bus 1 EQ high frequency (Hz)
/bus/1/eq/hq	F	0.44..10	181 steps	Bus 1 EQ high Q
/bus/1/eq/heq	S		PEQ, SHV, CUT, BW6, BW12, BS12, LR12, BW18, BW24, BS24, LR24, BW48, LR48	Bus 1 EQ high type
/bus/1/eq/tilt	F	-6..6	49 steps	Bus 1 EQ tilt level
/bus/1/dyn	N			Bus 1 dynamic (compressor) node
/bus/1/dyn/on	I	0..1		Bus 1 compressor switch
/bus/1/dyn/mdl	S		COMP, EXP, B160, B560, D241, ECL33, 9000C, SBUS, RED3, 76LA, LA, F670, BLISS, NSTR, WAVE, RIDE, 2250, L100, CMB <sup>30</sup>	Bus 1 compressor model, (see Appendix on Compressor plugins for parameters details, OSC patterns in <i>italic</i> below correspond to COMP)
/bus/1/dyn/mix	F	0..100	101 steps	Bus 1 compressor mix (%)
/bus/1/dyn/gain	F	-6..12	37 steps	Bus 1 compressor gain (dB)
/bus/1/dyn/thr <sup>31</sup>	F	-60..0	121 steps	Bus 1 compressor threshold (dB)
/bus/1/dyn/ratio	F	1.1..100		Bus 1 compressor ratio
/bus/1/dyn/knee	I	0..5		Bus 1 compressor knee
/bus/1/dyn/det	S		PEAK, RMS	Bus 1 compressor detect
/bus/1/dyn/att	F	0..120	121 steps	Bus 1 compressor attack (ms)
/bus/1/dyn/hld	F	1..200	200 steps	Bus 1 compressor hold (ms)
/bus/1/dyn/rel	F	4..4000	130 steps	Bus 1 compressor release (ms)
/bus/1/dyn/env	S		Lin, Log	Bus 1 compressor envelope
/bus/1/dyn/auto	I	0..1		Bus 1 compressor auto switch
/bus/1/dynxo	N			Bus 1 compressor crossover node
/bus/1/dynxo/depth	F	0..20	41 steps	Bus 1 compressor crossover depth (dB)
/bus/1/dynxo/type	S		OFF, LO6, LO12, HI6, HI12, PC	Bus 1 compressor crossover type
/bus/1/dynxo/f	F	20..20000	901 steps	Bus 1 compressor crossover frequency (Hz)
/bus/1/dynxo/\$solo	I	0..1		Bus 1 compressor crossover solo
/bus/1/dynsc	N			Bus 1 compressor sidechain node
/bus/1/dynsc/type	S		OFF, LP12, HP12, BP	Bus 1 compressor sidechain type
/bus/1/dynsc/f	F	20..20000	901 steps	Bus 1 compressor sidechain frequency (Hz)
/bus/1/dynsc/q	F	0.44..10	181 steps	Bus 1 compressor sidechain Q
/bus/1/dynsc/src	S		SELF, BUS.1..BUS.16, MAIN.1..MAIN.4, MTX.1..MTX.8, AUX.1..AUX.8	Bus 1 compressor sidechain source
/bus/1/dynsc/tap	S		BUS, DYN, PFL, AFL, EQ, INS2	Bus 1 compressor sidechain tap

<sup>30</sup> Side chain EQ is not available when auxcombo [CMB] is used in dyn slot

<sup>31</sup> This is for the COMP dyn model. Can use more parameters depending on model type

/bus/1/dynsc/\$solo	I	0..1		Bus 1 compressor sidechain solo
/bus/1/preins	N			Bus 1 pre-insert node
/bus/1/preins/on	I	0..1		Bus 1 pre-insert switch
/bus/1/preins/ins	S		NONE, FX1..FX16	Bus 1 pre-insert FX slot
/bus/1/preins/\$stat	S		-, OK, N/A	Bus 1 pre-insert status [RO]
/bus/1/main	N			Bus 1 Main node
/bus/1/main/1	N	1..4		Bus 1 Main 1 node
/bus/1/main/1/on	I	0..1		Bus 1 Main 1 on switch
/bus/1/main/1/lvl	F	-144..10	-oo..10 in 1024 steps	Bus 1 Main 1 fader level (dB)
/bus/1/main/1/pre	I	0..1		Bus 1 sent pre fader to Main 1
/bus/1/send	N			Bus 1 sends node
/bus/1/send/1	N	1..16		Bus 1 sends 1 node
/bus/1/send/1/on	I	0..1		Bus 1 sends 1 on switch <sup>32</sup>
/bus/1/send/1/lvl	F	-144..10	-oo..10 in 1024 steps	Bus 1 sends 1 fader level (dB)
/bus/1/send/1/pre	I	0..1		Bus 1 sends 1 pre/post switch
/bus/1/send/MX<x>	N	<x>:1..8		Bus 1 matrix <x> sends node
/bus/1/send/MX<x>/on	I	0..1		Bus 1 mtx on switch
/bus/1/send/MX<x>/lvl	F	-144..10	-oo..10 in 1024 steps	Bus 1 mtx fader level (dB)
/bus/1/send/MX<x>/pre	I	0..1		Bus 1 mtx pre/post switch
/bus/1/postins	N			Bus 1 post insert node
/bus/1/postins/on	I	0..1		Bus 1 post insert on switch
/bus/1/postins/ins	S		NONE, FX1..FX16	Bus 1 post insert mode
/bus/1/postins/\$stat	S		-, OK, N/A	Bus 1 post insert status [RO]
/bus/1/dly	N			Bus 1 delay node
/bus/1/dly/on	I	0..1		Bus 1 delay on
/bus/1/dly/mode	S		M, FT, MS, SMP	Meters, feet, milliseconds, samples
/bus/1/dly/dly	F	0..150 m / 0.5..500 ft/ 0.5..500 ms/ 16..500 smp	1501 steps / 1000 steps / 4996 steps / 485 steps	Bus 1 delay (meters, feet, ms, samples)
/bus/1/tags	S		80 chars max	Bus 1 tags <sup>33</sup>
/bus/1/\$fdr	F	-144..10	-oo..10 in 1024 steps	Bus 1 fader level as affected by dca (dB)[RO]
/bus/1/\$mute	I	0..2		Bus 1 mute [RO]
/bus/1/\$muteovr	I	0..1		Bus 1 mute override

<sup>32</sup> Sending bus 'n' to bus 'n' is not possible. For ex. trying to enable /bus/1/send/1/on will be ignored.

<sup>33</sup> Tags #D1..#D16 are 'reserved' for DCA1..16 assignment

## Mains Settings

Command	Type	Range	Text	Description
/main	N			Main node
/main/1	N	1..4		Main 1 node
/main/1/in	N			Main 1 input node
/main/1/in/set	N			Main 1 input set node
/main/1/in/set/inv	I	0..1		Main 1 input phase invert switch
/main/1/in/set/trim	F	-18..18	361 steps	Main 1 input trim
/main/1/in/set/bal	F	-9..9	181 steps	Main 1 input balance
/main/1/col	I	1..12		Main 1 color
/main/1/name	S		16 chars max	Main 1 name
/main/1/icon	I	0..999		Main 1 icon
/main/1/led	I	0..1		Main 1 scribble light
/main/1/\$col	I	1..12		Main 1 color [RO] reflects linked source or current strip value
/main/1/\$name	S		16 chars max	Main 1 name [RO] reflects linked source or current strip value
/main/1/\$icon	I	0..999		Main 1 icon [RO] reflects linked source or current strip value
/main/1/busmono	I	0..1		Main 1 mono switch
/main/1/mute	I	0..1		Main 1 mute
/main/1/fdr	F	-144..10	-oo..10 in 1024 steps	Main 1 fader level (dB)
/main/1/pan	F	-100..100	201 steps	Main 1 pan
/main/1/wid	F	-150..150	61 steps	Main 1 width (%)
/main/1/\$solo	I	0..1		Main 1 solo switch
/main/1/\$sololed	I	0..2		Main 1 solo LED [RO]
/main/1/mon	S		A, B, A+B	Main 1 monitor mode
/main/1/eq	N			Main 1 EQ node
/main/1/eq/on	I	0..1		Main 1 EQ on switch
/main/1/eq/mdl	S		STD, SOUL, E88, E84, F110, PULSAR, PIA	Main 1 EQ model, (see Appendix on EQ plugins for parameters details, OSC patterns in italic below correspond to STD)
/main/1/eq/mix	F	0..100	126 steps	Main 1 EQ mix
/main/1/eq/\$solo	I	0..1		Main 1 EQ solo
/main/1/eq/\$solobd	I	0..1		Main 1 EQ band solo
/main/1/eq/l <sup>g</sup> <sup>34</sup>	F	-15..15	301 steps	Main 1 EQ low gain (dB)
/main/1/eq/l <sup>f</sup>	F	20..20000	641 steps	Main 1 EQ low frequency (Hz)
/main/1/eq/l <sup>q</sup>	F	0.44..10	181 steps	Main 1 EQ low Q
/main/1/eq/l <sup>e</sup> <sub>q</sub>	S		PEQ, SHV, CUT, BW6, BW12, BS12, LR12, BW18, BW24, BS24, LR24, BW48, LR48	Main 1 EQ low type
/main/1/eq/1 <sup>g</sup>	F	-15..15	301 steps	Main 1 EQ band 1 gain (dB)
/main/1/eq/1 <sup>f</sup>	F	20..20000	961 steps	Main 1 EQ band 1 frequency (Hz)
/main/1/eq/1 <sup>q</sup>	F	0.44..10	181 steps	Main 1 EQ band 1 Q
/main/1/eq/2 <sup>g</sup>	F	-15..15	301 steps	Main 1 EQ band 2 gain (dB)
/main/1/eq/2 <sup>f</sup>	F	20..20000	961 steps	Main 1 EQ band 2 frequency (Hz)
/main/1/eq/2 <sup>q</sup>	F	0.44..10	181 steps	Main 1 EQ band 2 Q
/main/1/eq/3 <sup>g</sup>	F	-15..15	301 steps	Main 1 EQ band 3 gain (dB)
/main/1/eq/3 <sup>f</sup>	F	20..20000	961 steps	Main 1 EQ band 3 frequency (Hz)
/main/1/eq/3 <sup>q</sup>	F	0.44..10	181 steps	Main 1 EQ band 3 Q

<sup>34</sup> This is for the STD eq model. Can use more parameters depending on model type

/main/1/eq/4g	F	-15..15	301 steps	Main 1 EQ band 4 gain (dB)
/main/1/eq/4f	F	20..20000	961 steps	Main 1 EQ band 4 frequency (Hz)
/main/1/eq/4q	F	0.44..10	181 steps	Main 1 EQ band 4 Q
/main/1/eq/5g	F	-15..15	301 steps	Main 1 EQ band 5 gain (dB)
/main/1/eq/5f	F	20..20000	961 steps	Main 1 EQ band 5 frequency (Hz)
/main/1/eq/5q	F	0.44..10	181 steps	Main 1 EQ band 5 Q
/main/1/eq/6g	F	-15..15	301 steps	Main 1 EQ band 6 gain (dB)
/main/1/eq/6f	F	20..20000	961 steps	Main 1 EQ band 6 frequency (Hz)
/main/1/eq/6q	F	0.44..10	181 steps	Main 1 EQ band 6 Q
/main/1/eq/hg	F	-15..15	301 steps	Main 1 EQ high gain (dB)
/main/1/eq/hf	F	50..20000	833 steps	Main 1 EQ high frequency (Hz)
/main/1/eq/hq	F	0.44..10	181 steps	Main 1 EQ high Q
/main/1/eq/heq	S		PEQ, SHV, CUT, BW6, BW12, BS12, LR12, BW18, BW24, BS24, LR24, BW48, LR48	Main 1 EQ high type
/main/1/eq/tilt	F	-6..6	49 steps	Main 1 EQ tilt level
/main/1/dyn	N			Main 1 dynamic (compressor) node
/main/1/dyn/on	I	0..1		Main 1 compressor switch
/main/1/dyn/mdl	S		COMP, EXP, B160, B560, D241, ECL33, 9000C, SBUS, RED3, 76LA, LA, F670, BLISS, NSTR, WAVE, RIDE, 2250, L100, CMB <sup>35</sup>	Main 1 compressor switch, (see Appendix on Compressor plugins for parameters details, OSC patterns in <i>italic</i> below correspond to COMP)
/main/1/dyn/mix	F	0..100	101 steps	Main 1 compressor mix (%)
/main/1/dyn/gain	F	-6..12	37 steps	Main 1 compressor gain (dB)
/main/1/dyn/thr <sup>36</sup>	F	-60..0	121 steps	Main 1 compressor threshold (dB)
/main/1/dyn/ratio	F	1.1..100		Main 1 compressor ratio
/main/1/dyn/knee	I	0..5		Main 1 compressor knee
/main/1/dyn/det	S		PEAK, RMS	Main 1 compressor detect
/main/1/dyn/att	F	0..120	121 steps	Main 1 compressor attack (ms)
/main/1/dyn/hld	F	1..200	200 steps	Main 1 compressor hold (ms)
/main/1/dyn/rel	F	4..4000	130 steps	Main 1 compressor release (ms)
/main/1/dyn/env	S		LIN, LOG	Main 1 compressor envelope
/main/1/dyn/auto	I	0..1		Main 1 compressor auto switch
/main/1/dynxo	N			Main 1 compressor crossover node
/main/1/dynxo/depth	F	0..20	41 steps	Main 1 compressor crossover depth (dB)
/main/1/dynxo/type	S		OFF, LO6, LO12, HI6, HI12, PC	Main 1 compressor crossover type
/main/1/dynxo/f	F	20..20000	901 steps	Main 1 compressor crossover frequency (Hz)
/main/1/dynxo/\$solo	I	0..1		Main 1 compressor crossover solo
/main/1/dynsc	N			Main 1 compressor sidechain node
/main/1/dynsc/type	S		OFF, LP12, HP12, BP	Main 1 compressor sidechain type
/main/1/dynsc/f	F	20..20000	901 steps	Main 1 compressor sidechain frequency (Hz)
/main/1/dynsc/q	F	0.44..10	181 steps	Main 1 compressor sidechain Q
/main/1/dynsc/src	S		SELF, BUS.1..BUS.16, MAIN.1..MAIN.4, MTX.1..MTX.8, AUX.1..AUX.8	Main 1 compressor sidechain source

<sup>35</sup> Side chain EQ is not available when auxcombo [CMB] is used in dyn slot

<sup>36</sup> This is for the COMP dyn model. Can use more parameters depending on model type

/main/1/dynsc/tap	S		BUS, DYN, PFL, AFL, EQ, INS2	Main 1 compressor sidechain tap
/main/1/dynsc/\$solo	I	0..1		Main 1 compressor sidechain solo
/main/1/preins	N			Main 1 pre-insert node
/main/1/preins/on	I	0..1		Main 1 pre-insert switch
/main/1/preins/ins	S		NONE, FX1..FX16	Main 1 pre-insert FX slot
/main/1/preins/\$stat	S		-, OK, N/A	Main 1 pre-insert status [RO]
/main/1/send	N			Main 1 sends node
/main/1/send/MX<x>	N	<x>: 1..8		Main 1 matrix <x> sends node
/main/1/send/MX<x>/on	I	0..1		Main 1 mtx on switch
/main/1/send/MX<x>/lvl	F	-144..10	-oo..10 in 1024 steps	Main 1 mtx fader level (dB)
/main/1/send/MX<x>/pre	I	0..1		Main 1 mtx pre/post switch
/main/1/postins	N			Main 1 post insert node
/main/1/postins/on	I	0..1		Main 1 post insert on switch
/main/1/postins/ins	S		NONE, FX1..FX16	Main 1 post insert mode
/main/1/postins/\$stat	S		-, OK, N/A	Main 1 post insert status [RO]
/main/1/dly	N			Main 1 delay node
/main/1/dly/on	I	0..1		Main 1 delay on switch
/main/1/dly/mode	S		M, FT, MS, SMP	Meters, feet, milliseconds, samples
/main/1/dly/dly	F	0..150 m / 0.5..500 ft/ 0.5..500 ms/ 16..500 smp	1501 steps / 1000 steps / 4996 steps / 485 steps	Main 1 delay (meters, feet, ms, samples)
/main/1/tags				
/main/1/\$fdr	S		80 chars max	Main 1 tags <sup>37</sup>
/main/1/\$mute	F	-144..10	-oo..10 in 1024 steps	Main 1 fader level as affected by dca (dB)[RO]
/main/1/\$muteovr	I	0..2		Main 1 mute [RO]
	I	0..1		Main 1 mute override

<sup>37</sup> Tags #D1..#D16 are 'reserved' for DCA1..16 assignment

## Matrix Settings

Command	Type	Range	Text	Description
/mtx	N			Matrix node
/mtx/1	N	1..8		Matrix 1 node
/mtx/1/in	N			Matrix 1 input node
/mtx/1/in/set	N			Matrix 1 input set node
/mtx/1/in/set/inv	I	0..1		Matrix 1 input phase invert
/mtx/1/in/set/trim	F	-18..18	361 steps	Matrix 1 input trim
/mtx/1/in/set/bal	F	-9..9	181 steps	Matrix 1 input balance
/mtx/1/dir	N			Matrix 1 direct input signal
/mtx/1/dir/on	I	0..1		Matrix 1 direct in on switch
/mtx/1/dir/lvl	F	-144..10	-∞..10 in 1024 steps	Matrix 1 direct in fader level (dB)
/mtx/1/dir/inv	I	0..1		Matrix 1 direct in invert
/mtx/1/dir/in	S		OFF, AES, MON.A, MON.B, MON.BUS	Matrix 1 direct in input source
/mtx/1/dir/tap	S		PRE, POST	Matrix 1 direct in tap
/mtx/1/col	I	1..12		Matrix 1 color
/mtx/1/name	S		16 chars max	Matrix 1 name
/mtx/1/icon	I	0..999		Matrix 1 icon
/mtx/1/led	I	0..1		Matrix 1 scribble light
/mtx/1/\$col	I	1..12		Matrix 1 color [RO] reflects linked source or current strip value
/mtx/1/\$name	S		16 chars max	Matrix 1 name [RO] reflects linked source or current strip value
/mtx/1/\$icon	I	0..999		Matrix 1 icon [RO] reflects linked source or current strip value
/mtx/1/busmono	I	0..1		Matrix 1 mono switch
/mtx/1/mute	I	0..1		Matrix 1 mute
/mtx/1/fdr	F	-144..10	-∞..10 in 1024 steps	Matrix 1 fader level (dB)
/mtx/1/pan	F	-100..100	201 steps	Matrix 1 pan
/mtx/1/wid	F	-150..150	61 steps	Matrix 1 width (%)
/mtx/1/\$solo	I	0..1		Matrix 1 solo switch
/mtx/1/\$sololed	I	0..2		Matrix 1 solo LED [RO]
/mtx/1/mon	S		A, B, A+B	Matrix 1 monitor mode
/mtx/1/eq	N			Matrix 1 EQ node
/mtx/1/eq/on	I	0..1		Matrix 1 EQ on switch
/mtx/1/eq/mdl	S		STD, SOUL, E88, E84, F110, PULSAR, PIA	Matrix 1 EQ model, (see Appendix on EQ plugins for parameters details, OSC patterns in <i>italic</i> below correspond to STD)
/mtx/1/eq/mix	F	0..125	126 steps	Matrix 1 EQ mix (%)
/mtx/1/eq/\$solo	I	0..1		Matrix 1 EQ solo
/mtx/1/eq/\$solobd	I	0..8		Matrix 1 EQ solo band
/mtx/1/eq/lg <sup>38</sup>	F	-15..15	301 steps	Matrix 1 EQ low gain (dB)
/mtx/1/eq/lf	F	20..2000	641 steps	Matrix 1 EQ low frequency
/mtx/1/eq/lq	F	0.44..10	181 steps	Matrix 1 EQ low Q
/mtx/1/eq/leq	S		SHV, PEQ, CUT	Matrix 1 EQ low type
/mtx/1/eq/1g	F	-15..15	301 steps	Matrix 1 EQ band 1 gain (dB)
/mtx/1/eq/1f	F	20..20000	961 steps	Matrix 1 EQ band 1 frequency (Hz)
/mtx/1/eq/1q	F	0.44..10	181 steps	Matrix 1 EQ band 1 Q

<sup>38</sup> This is for the STD eq model. Can use more parameters depending on model type

/mtx/1/eq/2g	F	-15..15	301 steps	Matrix 1 EQ band 2 gain (dB)
/mtx/1/eq/2f	F	20..20000	961 steps	Matrix 1 EQ band 2 frequency (Hz)
/mtx/1/eq/2q	F	0.44..10	181 steps	Matrix 1 EQ band 2 Q
/mtx/1/eq/3g	F	-15..15	301 steps	Matrix 1 EQ band 3 gain (dB)
/mtx/1/eq/3f	F	20..20000	961 steps	Matrix 1 EQ band 3 frequency (Hz)
/mtx/1/eq/3q	F	0.44..10	181 steps	Matrix 1 EQ band 3 Q
/mtx/1/eq/4g	F	-15..15	301 steps	Matrix 1 EQ band 4 gain (dB)
/mtx/1/eq/4f	F	20..20000	961 steps	Matrix 1 EQ band 4 frequency (Hz)
/mtx/1/eq/4q	F	0.44..10	181 steps	Matrix 1 EQ band 4 Q
/mtx/1/eq/5g	F	-15..15	301 steps	Matrix 1 EQ band 5 gain (dB)
/mtx/1/eq/5f	F	20..20000	961 steps	Matrix 1 EQ band 5 frequency (Hz)
/mtx/1/eq/5q	F	0.44..10	181 steps	Matrix 1 EQ band 5 Q
/mtx/1/eq/6g	F	-15..15	301 steps	Matrix 1 EQ band 6 gain (dB)
/mtx/1/eq/6f	F	20..20000	961 steps	Matrix 1 EQ band 6 frequency (Hz)
/mtx/1/eq/6q	F	0.44..10	181 steps	Matrix 1 EQ band 6 Q
/mtx/1/eq/hg	F	-15..15	301 steps	Matrix 1 EQ high gain (dB)
/mtx/1/eq/hf	F	50..20000	833 steps	Matrix 1 EQ high frequency (Hz)
/mtx/1/eq/hq	F	0.44..10	181 steps	Matrix 1 EQ high Q
/mtx/1/eq/heq	S		SHV, PEQ, CUT	Matrix 1 EQ high type
/mtx/1/eq/tilt	F	-6..6	49 steps	Matrix 1 EQ tilt level (dB)
/mtx/1/dyn	N			Matrix 1 dynamic (compressor) node
/mtx/1/dyn/on	I	0..1		Matrix 1 compressor switch
/mtx/1/dyn/mdl	S		COMP, EXP, B160, B560, D241, ECL33, 9000C, SBUS, RED3, 76LA, LA, F670, BLISS, NSTR, WAVE, RIDE, 2250, L100, CMB <sup>39</sup>	Matrix 1 compressor model, (see Appendix on Compressor plugins for parameters details, OSC patterns in italic below correspond to COMP)
/mtx/1/dyn/mix	F	0..100	101 steps	Matrix 1 compressor mix (%)
/mtx/1/dyn/gain	F	-6..12	37 steps	Matrix 1 compressor gain (dB)
/mtx/1/dyn/thr <sup>40</sup>	F	-60..0	121 steps	Matrix 1 compressor threshold (dB)
/mtx/1/dyn/ratio	F	1.1..100		Matrix 1 compressor ratio
/mtx/1/dyn/knee	I	0..5		Matrix 1 compressor knee
/mtx/1/dyn/det	S		PEAK, RMS	Matrix 1 compressor detect
/mtx/1/dyn/att	F	0..120	121 steps	Matrix 1 compressor attack (ms)
/mtx/1/dyn/hld	F	1..200	200 steps	Matrix 1 compressor hold (ms)
/mtx/1/dyn/rel	F	4..4000	130 steps	Matrix 1 compressor release (ms)
/mtx/1/dyn/env	S		LIN, LOG	Matrix 1 compressor envelope
/mtx/1/dyn/auto	I	0..1		Matrix 1 compressor auto switch
/mtx/1/dynxo	N			Matrix 1 compressor crossover node
/mtx/1/dynxo/depth	F	0..20	41 steps	Matrix 1 compressor crossover depth (dB)
/mtx/1/dynxo/type	S		OFF, LO6, LO12, HI6, HI12, PC	Matrix 1 compressor crossover type
/mtx/1/dynxo/f	F	20..20000	901 steps	Matrix 1 compressor crossover frequency (Hz)
/mtx/1/dynxo/\$solo	I	0..1		Matrix 1 compressor crossover solo
/mtx/1/dynsc	N			Matrix 1 compressor sidechain node
/mtx/1/dynsc/type	S		OFF, LP12, HP12, BP	Matrix 1 compressor sidechain type
/mtx/1/dynsc/f	F	20..20000	901 steps	Matrix 1 compressor sidechain frequency (Hz)
/mtx/1/dynsc/q	F	0.44..10	181 steps	Matrix 1 compressor sidechain Q

<sup>39</sup> Side chain EQ is not available when auxcombo [CMB] is used in dyn slot

<sup>40</sup> This is for the COMP dyn model. Can use more parameters depending on model type



/mtx/1/dynsc/src	S		SELF, BUS.1..BUS.16, MAIN.1..MAIN.4, MTX.1..MTX.8, AUX.1..AUX.8	Matrix 1 compressor sidechain source
/mtx/1/dynsc/tap	S		BUS, DYN, PFL, AFL, EQ, INS2	Matrix 1 compressor sidechain tap
/mtx/1/dynsc/\$solo	I	0..1		Matrix 1 compressor sidechain solo
/mtx/1/preins	N			Matrix 1 pre-insert node
/mtx/1/preins/on	I	0..1		Matrix 1 pre-insert switch
/mtx/1/preins/ins	S		NONE, FX1..FX16	Matrix 1 pre-insert FX slot
/mtx/1/preins/\$stat	S		-,OK, N/A	Matrix 1 pre-insert status [RO]
/mtx/1/postins	N			Matrix 1 post insert node
/mtx/1/postins/on	I	0..1		Matrix 1 post insert on switch
/mtx/1/postins/ins	S		NONE, FX1..FX16	Matrix 1 post insert mode
/mtx/1/postins/\$stat	S		-,OK, N/A	Matrix 1 post insert status [RO]
/mtx/1/dly	N			Matrix 1 delay node
/mtx/1/dly/on	I	0..1		Matrix 1 delay on switch
/mtx/1/dly/mode	S		M, FT, MS, SMP	Meters, feet, milliseconds, samples
/mtx/1/dly/dly	F	0..150 m / 0.5..500 ft/ 0.5..500 ms/ 16..500 smp	1501 steps / 1000 steps / 4996 steps / 485 steps	Matrix 1 delay (meters, feet, ms, samples)
/mtx/1/tags	S		80 chars max	Matrix 1 tags <sup>41</sup>
/mtx/1/\$fdr	F	-144..10	-oo..10 in 1024 steps	Matrix 1 fader level as affected by dca (dB)[RO]
/mtx/1/\$mute	I	0..2		Matrix 1 mute [RO]
/mtx/1/\$muteovr	I	0..1		Matrix 1 mute override

<sup>41</sup> Tags #D1..#D16 are 'reserved' for DCA1..16 assignment

## DCA Settings

Command	Type	Range	Text	Description
/dca	N			DCA node
/dca/1	N	1..16		DCA 1 node
/dca/1/name	S		8 chars max	DCA 1 name
/dca/1/col	I	1..12		DCA 1 color
/dca/1/icon	I	0..999		DCA 1 icon
/dca/1/led	I	0..1		DCA 1 scribble light
/dca/1/mute	I	0..1		DCA 1 mute
/dca/1/fdr	F	-144..10	-oo..10 in 1024 steps	DCA 1 fader (dB)
/dca/1/\$solo	I	0..1		DCA 1 solo
/dca/1/\$sololed	I	0..1		DCA 1 solo LED [RO]
/dca/1/mon	S		A, B, A+B	DCA 1 monitor mode

## Mutegroup Settings

Command	Type	Range	Text	Description
/mgrp	N			Mutegroup node
/mgrp/1	N	1..8		Mutegroup 1 node
/mgrp/1/name	S		8 chars max	Mutegroup 1 name
/mgrp/1/mute	I	0..1		Mutegroup 1 mute

## Effects Settings

Command	Type	Range	Text	Description
/fx	N			FX node
/fx/1	N	1..16		FX 1 node
/fx/1/mdl	S		<p>For /fx/1../fx/8:</p> <p>NONE, EXT, HALL, ROOM, CHAMBER, PLATE, CONCERT, AMBI, V-ROOM, V-REV, V-PLATE, GATED, REVERSE, DEL/REV, SHIMMER, SPRING, DIMCRS, CHORUS, FLANGER, ST-DL, TAP-DL, TAPE-DL, OILCAN, BBD-DL, PITCH, D-PITCH, VSS3, BPLATE, GEQ, PIA, DOUBLE, PCORR, LIMITER, DE-S2, ENHANCE, EXCITER, P-BASS, ROTARY, PHASER, PANNER, TAPE, MOOD, SUB, RACKAMP, UKROCK, ANGEL, JAZZC, DELUXE, BODY, SOUL, E88, E84, F110, PULSAR, MACH4, C5-CMB, SUB-M, V-IMG, SPKMAN, DEQ3, *EVEN*, *SOUL*, *VINTAGE*, *BUS*, *MASTER*</p> <p>For /fx/9../fx/16:</p> <p>NONE, EXT, GEQ, PIA, DOUBLE, PCORR, LIMITER, DE-S2, ENHANCE, EXCITER, P-BASS, ROTARY, PHASER, PANNER, TAPE, MOOD, SUB, RACKAMP, UKROCK, ANGEL, JAZZC, DELUXE, BODY, SOUL, E88, E84, F110, PULSAR, MACH4, C5-CMB, SUB-M, V-IMG, SPKMAN, DEQ3, *EVEN*, *SOUL*, *VINTAGE*, *BUS*, *MASTER*</p>	FX 1 model (see Appendix for details, graphics and parameter values)
/fx/1/fxmix	F	0..100	101 steps	FX 1 mix % (depends on FX)
/fx/1/\$esrc	I	0..400		FX 1 source [RO]
/fx/1/\$emode	S		M, ST, M/S	FX 1 mode [RO]
/fx/1/\$a_chn	I	0..76		FX 1 channel assigned to it [RO]
/fx/1/\$a_pos	I	0..1		FX 1 channel insert (0=pre, 1=post) [RO]
/fx/1/...				<p>/fx/1/... contains up to 40<sup>42</sup> parameters that depend on the selected model (/fx/1/mdl), as listed in the Appendix section.</p> <p>For the current version of FW, the highest parameter number used is 33</p>

<sup>42</sup> 1..40 are for FX parameters, 41 is for FX Mix

## Cards Settings

Command	Type	Range	Text	Description
/cards	N			Cards node
/cards/\$type	S		NONE, WLIVE, WDANTE, WLINK	Cards type [RO]
/cards/\$ver	S		32 chars max	Cards version [RO]
/cards/wlive	N			Cards W-Live node
/cards/wlive/sdlink	S		IND, PAR	Cards W-Live SD parallel mode
/cards/wlive/\$actlink	S		IND, PAR	Cards W-Live ACT link [RO]
/cards/wlive/\$battstate	S		NONE, GOOD, LOW	Cards W-Live battery status [RO]
/cards/wlive/autoin	S		OFF, 1, 2	Cards W-Live auto input
/cards/wlive/meters	I	0..1		Cards show meters
/cards/wlive/auto_stop	S		KEEP, MAIN, ALT	Cards W-Live settings when Stop
/cards/wlive/auto_play	S		KEEP, MAIN, ALT	Cards W-Live settings when Play
/cards/wlive/auto_rec	S		KEEP, MAIN, ALT	Cards W-Live settings when Rec
/cards/wlive/1	N	1..2		Cards W-Live 1 node
/cards/wlive/1/\$ctl	N			Cards W-Live 1 ctl node
/cards/wlive/1/\$ctl/control	S		STOP, PPAUSE, PLAY, REC	Cards W-Live 1 control
/cards/wlive/1/\$ctl/opensession	I	0..100		Cards W-Live 1 open session #
/cards/wlive/1/\$ctl/editmarker	I	0..100		Cards W-Live 1 edit marker (set marker to current PAUSE time or last start PLAY time)
/cards/wlive/1/\$ctl/gotomarker	I	0..101		Cards W-Live 1 goto marker # 101 is used to validate stime data
/cards/wlive/1/\$ctl/deletemarker	I	0..100		Cards W-Live 1 delete marker #
/cards/wlive/1/\$ctl/deletesession	I	0..100		Cards W-Live 1 delete session #
/cards/wlive/1/\$ctl/stime	F	0..36000000	36000000 steps	Cards W-Live 1 time (ms). Must be followed by a \$ctl/gotomarker 101 to be taken into account
/cards/wlive/1/\$ctl/namesession	S		19 chars max	Cards W-Live 1 name session. Works only in STOP mode.
/cards/wlive/1/\$ctl/setmarker	I	0..1		Cards W-Live 1 set marker
/cards/wlive/1/\$ctl/formatsdcard	I	0..1		Cards W-Live 1 format SD card
/cards/wlive/1/cfg	N			Cards W-Live 1 cfg node
/cards/wlive/1/cfg/retracks	S		32, 16, 8	Cards W-Live 1 rec tracks
/cards/wlive/1/cfg/playmode	S		PLAY, A->B, LOOP	Cards W-Live 1 play mode
/cards/wlive/1/\$stat	N			Cards W-Live 1 status node
/cards/wlive/1/\$stat/state	S		STOP, PPAUSE, PLAY, REC	Cards W-Live 1 state [RO]
/cards/wlive/1/\$stat/etime	F	0..36000000	36000000 steps	Cards W-Live 1 etime (current time)
/cards/wlive/1/\$stat/sdfree	F	0..36000000	36000000 steps	Cards W-Live 1 SD free space
/cards/wlive/1/\$stat/sdsize	I	0..1024		Cards W-Live 1 SD size (Gb) [RO]
/cards/wlive/1/\$stat/sdstate	S		NONE, READY, PROTECT, ERASE, ERROR	Cards W-Live 1 SD state [RO]
/cards/wlive/1/\$stat/sessionlist	S		Ex: 2020-04-04 10:16:36, 2020-01-27 19:59:02, ...	Cards W-Live 1 list of session recorded date and time
/cards/wlive/1/\$stat/markerlist	S			Cards W-Live 1 current marker time

/cards/wlive/1/\$stat/snamelist	S		Ex: CC Hard Candy Fi, CC Mr Jones	Cards W-Live 1 session names list <sup>43</sup> [RO]
/cards/wlive/1/\$stat/sessions	I	0..100		Cards W-Live 1 total number of sessions [RO]
/cards/wlive/1/\$stat/markers	I	0..100		Cards W-Live 1 total number of markers [RO]
/cards/wlive/1/\$stat/sessionlen	F	0..36000000	36000000 steps	Cards W-Live 1 session length [RO]
/cards/wlive/1/\$stat/sessionpos	I	0..100		Cards W-Live 1 session position
/cards/wlive/1/\$stat/markerpos	I	0..100		Cards W-Live 1 marker position
/cards/wlive/1/\$stat/tracks	S		32, 16, 8	Cards W-Live 1 track number in current session [RO]
/cards/wlive/1/\$stat/rate	S		44.1, 48	Cards W-Live 1 sample rate [RO]
/cards/wlive/1/\$stat/linkedpos	I	0..100		Cards W-Live session link position in the other card (only when a linked session is active) <sup>44</sup>
/cards/wlive/1/\$stat/start	F	0..36000000	36000000 steps	Cards W-Live 1 start
/cards/wlive/1/\$stat/stop	F	0..36000000	36000000 steps	Cards W-Live 1 stop
/cards/wlive/1/\$stat/errormessage	S		32 chars max	Cards W-Live 1 error message [RO]
/cards/wlive/1/\$stat/errorcode	I	0..34		Cards W-Live 1 error code [RO]

<sup>43</sup> Only the first name of the list is returned by std OSC command. You must use the node definition command (OSC or native interface) to get the full contents.

<sup>44</sup> There can be a maximum of 100 sessions per card

## USB Player Settings

Command	Type	Range	Text	Description
/play <sup>45</sup>	N			USB Player node
/play/\$songs	S		List of strings	List of songs [RO] <sup>46</sup>
/play/\$actlist	S		256 chars max	Path to USB files [RO]
/play/\$actidx	I		1..n	Current active entry in the playlist
/play/\$actionidx	I		1..n	[RO]
/play/\$playfile	S		256 chars max	Full path to a song to play using <code>/play/\$action ,s PLAYFILE</code>
/play/\$action	S		IDLE, STOP, PLAY, PAUSE, NEXT, PREV, PLAYFILE	USB Player action
/play/\$actstate	S		STOP, PLAY, PAUSE, ERROR	USB Player active state [RO]
/play/\$actfile	S		256 chars max	USB Player active file [RO]
/play/\$song	S		64 chars max	USB Player song [RO]
/play/\$album	S		64 chars max	USB Player album [RO]
/play/\$artist	S		64 chars max	USB Player artist [RO]
/play/\$pos	F	0..35999	36000 steps	USB Player position
/play/\$total	F	0..35999	36000 steps	USB Player total time [RO]
/play/\$resolution	S		16, 24	USB Player resolution [RO]
/play/\$channels	S		1, 2, 3, 4	USB Player channels [RO]
/play/\$rate	S		44.1, 48	USB Player sample rate [RO]
/play/\$format	S		WAV, MP3, FLAC	USB Player format [RO]
/play/repeat	I	0..1		USB Player repeat
/rec	N			USB Recorder node
/rec/\$actstate	S		STOP, REC, PAUSE, ERROR	USB Recorder active state
/rec/\$actfile	S			USB Recorder active filename
/rec/\$action	S		STOP, REC, PAUSE, NEWFILE	USB Recorder action
/rec/path	S			USB Recorder filename path
/rec/resolution	S			USB Recorder resolution
/rec/channels	S			USB Recorder channels
/rec/\$time	F			USB Recorder time

<sup>45</sup> These commands are valid only when a playlist is active, and opened.

<sup>46</sup> Will provide only the first element of the list. Use the node level request to get the full list of songs in the playlist, for ex:  
`/play~~~,s~~?~~~`

## WING ce\_data OSC commands list

Control Settings, listed below, form a large set of OSC commands and parameters, all<sup>47</sup> under the *ce\_data* section in JSON snapshot files.

### Control Settings

Command	Type	Range	Text	Description
/Sctl	N			Control node
/Sctl/\$stat	N			Control status node
/Sctl/\$stat/selidx	I	1..76		Channel strip selected ID <sup>48</sup>
/Sctl/\$stat/pageidx	I	0..30		Channel page ID
/Sctl/\$stat/bandidx	I	1..8		Channel EQ band ID
/Sctl/\$stat/sof	I	-1..76		Sends on fader (SoF) status [-1 is the currently selected channel]
/Sctl/\$stat/cnslck	S		19 chars when locked 0 chars if unlocked	Console lock [RO] – The console lock string is made of 19 characters 0 or 1 depending on which screen buttons were pressed to lock the console. Characters 1 to 7 map to the buttons on the screen left, starting with HOME [ASSIGN is char #7], and characters 18 & 19 map to the buttons on the right side of the screen. Other characters are always 0. Ex: 1001001000000000000 - buttons HOME, ROUTING and ASSIGN have been used to lock the desk.
/Sctl/\$stat/sendpage	S		BUS, MATRIX	Bus or matrix Sends being displayed on screen
/Sctl/\$stat/chsetuptab	I	1..4	1: OVERVIEW 2: ICON/COLOR 3: NAME 4: TAGS	HOME page tab being displayed on screen
/Sctl/cfg	N			Control config node
/Sctl/cfg/lights	N			Lights node
/Sctl/cfg/lights/btns	I	0..100		Buttons backlight intensity
/Sctl/cfg/lights/leds	I	5..100		Buttons/LED light intensity
/Sctl/cfg/lights/meters	I	0..100		Meters intensity
/Sctl/cfg/lights/rgbleds	I	0..100		Color LED intensity (scribble lights)
/Sctl/cfg/lights/chlcds	I	5..100		Channel LCD intensity (scribble backlight)
/Sctl/cfg/lights/chlcdctr	I	0..100		Channel LCD contrast (scribble contrast)
/Sctl/cfg/lights/chedit	I	5..100		Channel strip intensity
/Sctl/cfg/lights/main	I	5..100		Touchscreen intensity
/Sctl/cfg/lights/glow	I	0..100		Under console light intensity
/Sctl/cfg/lights/patch	I	0..100		Patch panel light intensity
/Sctl/cfg/lights/lamp	I	0..100		Lamp light intensity

<sup>47</sup> Except for /Sctl/\$stat, and parameters /Sctl/cfg/\$noautosave and /Sctl/cfg/savenow

<sup>48</sup> The get command reports values between 0 and 75, but index 1 to 76 should be used when setting values.

/Sctl/cfg/rta <sup>49</sup>	N			RTA node (view options)
/Sctl/cfg/rta/homedisp	S		OFF, 1/3, FULL	RTA home size/mode
/Sctl/cfg/rta/homecol	S		RD25, RD50, RD75, AM25, AM50, AM75, BL25, BL50, BL75	RTA home color
/Sctl/cfg/rta/hometap	S		IN, EQ, POST	RTA home tap
/Sctl/cfg/rta/eqdisp	S		Off, 1/4, 1/3, 1/2, OVL/3, OVL	RTA EQ size/mode
/Sctl/cfg/rta/eqcol	S		RD25, RD50, RD75, AM25, AM50, AM75, BL25, BL50, BL75	RTA EQ color
/Sctl/cfg/rta/cheqtap	S		PRE, POST	RTA EQ tap
/Sctl/cfg/rta/chflttap	S		PRE, POST	RTA Channel filter tap
/Sglobals/muteovr	I	0..1		Chan strip mute overrides mute group
/Sctl/cfg/soloexcl	I	0..1		Solo exclusive
/Sctl/cfg/selfsolo	I	0..1		Select follows solo
/Sctl/cfg/solofsel	I	0..1		Solo follows select
/Sctl/cfg/sof2solo	I	0..1		Bus SOF activates solo
/Sctl/cfg/layerlinkl	I	0..1		User Layer link left/center
/Sctl/cfg/layerlinkr	I	0..1		User Layer link center/right
/Sctl/cfg/autoview	I	0..1		Screen follows channel strip
/Sctl/cfg/csctouch	I	0..1		Channel strip touch select
/Sctl/cfg/autosel_L	I	0..1		Channel auto select left
/Sctl/cfg/autosel_C	I	0..1		Channel auto select center
/Sctl/cfg/autosel_R	I	0..1		Channel auto select right
/Sctl/cgf/autosel_CMPCT	I	0..1		Compact Layer
/Sctl/cgf/autosel_RCK	I	0..1		Rack Layer
/Sctl/cgf/autosel_EXT	I	0..1		Ext Layer <sup>50</sup>
/Sctl/cgf/autosel_VRT	I	0..1		Virtual Layer
/Sctl/cfg/fdrbanking	I	0..1		Full fader paging
/Sctl/cfg/soffdr	S		L/C, ALL	SOF Faders (L/C: left/center)
/Sctl/cfg/sofbutton	S		AUTO, ON, FLASH	SOF button mode
/Sctl/cfg/sofframe	I	0..1		SOF frame
/Sctl/cfg/sofmode	I	0..1		Alternative SOF mode
/Sctl/cfg/seldblclick	S		OFF, HOME, BUSFX	Where Double click select takes you
/Sctl/cfg/usrmode	S		BUS, CC	Use F1-F3 as BUS or Custom Control
/Sctl/cfg/mfdr	S		OFF, MAIN.1, .., MAIN.4, MTX.1,.., MTX.8, DCA.1, .., DCA.16	What functionality is assigned to the Compact model fader 13/Main
/Sctl/cfg/cscmode	S		BUS, DCA, MAIN, USER	Operation mode for the 16 buttons of Compact model
/Sctl/cfg/rackmode	S		CH, MGRP, CC, USB, SD-A, SD-B	Operation mode for the 4 CC section on Rack model
/Sctl/cfg/busspill	I	0..1		Compact model only: 1: <b>push</b> ->bus spill, <b>hold</b> ->bus send 0: <b>push</b> ->bus send, <b>hold</b> ->bus spill
/Sctl/cfg/mainspill	I	0..1		Compact model only: 1: <b>push</b> ->main spill, <b>hold</b> ->main send 0: <b>push</b> ->main send, <b>hold</b> ->main spill
/Sctl/cfg/mtxspill	I	0..1		Compact model only: 1: <b>push</b> ->mtx spill, <b>hold</b> ->mtx send 0: <b>push</b> ->mtx send, <b>hold</b> ->mtx spill

<sup>49</sup> See also /cfg/rta commands

<sup>50</sup> EXT: Reserved in the present FW release



/Sctl/cfg/dcaspill	I	0..1		1: <b>push</b> ->dca spill, <b>hold</b> ->dca [un]select 0: <b>push</b> ->dca show, <b>hold</b> ->dca [un]select
/Sctl/cfg/dcacc	I	0..1		16 User Custom Control buttons on DCA buttons activated [Compact only]
/Sctl/cfg/showfdr	I	0..1		Temporarily show fader value on respective scribble when moving faders
/Sctl/layer	N			Layer node
/Sctl/layer/L	N			Left WING [only] layer node
/Sctl/layer/L/sel	I	1..22	1..7 settable <sup>51</sup> 8..9 no-op 10..22 fixed/pre-assigned	Left WING [only] layer select <sup>52</sup> 1: Ch 1..Ch 12 2: Ch 13..Ch 24 3: Ch 25..Ch 36 4: Ch 36..Ch 40 / Aux 1..Aux 8 5: Bus 1..Bus 12 6: User 1 7: User 2 8: No-op 9: No-op 10: Ch 1..Ch 8 11: Ch 9..Ch 16 12: Ch 17..Ch 24 13: Ch 25..Ch 32 14: Ch 33..Ch 40 15: Aux 1..Aux 8 16: Bus 1..Bus 8 17: Bus 9..Bus 16 18: Main 1..Main 4 19: Matrix 1..Matrix 8 20: DCA 1..DCA 8 21: DCA 9..DCA 16 22: spilled layer
/Sctl/layer/L/spidx	I	0..63		Spilled group 0: OFF 1..16: DCA 1..16 17-32: FX 1..16 33-48: BUS 1..16 [TBV] 49..56: MTX 1..16 [TBV] 57..60: MAIN 1..4 [TBV] 61: AUTOX 62: AUTOY 63: SOF
/Sctl/layer/L/1	N	1..7		Left WING [only] layer 1 node (see above)
/Sctl/layer/L/1/ofs	I	0..12		Left WING [only] layer 1 offset (from <4 or4> keys for ex.)
/Sctl/layer/L/1/name	S		10 chars max CH1-12, CH13-24, CH25-36, CH37-AUX, BUSES, USER1, USER2	Left WING [only] layer 1 name
/Sctl/layer/L/1/1	N	1..24		Left WING [only] layer 1, node 1
/Sctl/layer/L/1/1/type	S		OFF, CH, BUS, DCA, MIDI, SEND, FX	Left WING [only] layer 1, node 1 type (OSC patterns in italic below correspond to MIDI type)
/Sctl/layer/L/1/1/i	I	1..127		Left WING [only] layer 1, node 1 index

<sup>51</sup> Full size console has 7 layers whereas Compact console has 9

<sup>52</sup> Full-size console layers names

/Sctl/layer/L/1/1/dst	I	1..28		Left WING [only] layer 1, node 1 destination index (used for type SEND)
/Sctl/layer/L/1/1/val	I	0..127		<i>Left WING [only] layer 1, node 1 value (when type MIDI)</i>
/Sctl/layer/L/\$spill				Left WING [only] \$spill
/Sctl/layer/L/\$spill/ofs	I	0..64		Left WING [only] \$spill offset
/Sctl/layer/L/\$spill/name	S		10 chars max	Left WING [only] layer \$spill name <sup>53</sup>
/Sctl/layer/L/\$spill/1	N	1..76		Left WING [only] layer \$spill, node 1
/Sctl/layer/L/\$spill/1/type	S		OFF, CH, BUS, DCA, MIDI, SEND, FX	Left WING [only] layer \$spill, node 1 type (OSC patterns in italic below correspond to MIDI type)
/Sctl/layer/L/\$spill1/i	I	1..127		Left WING [only] layer \$spill, node 1 index
/Sctl/layer/L/\$spill1/dst	I	1..28		Left WING [only] layer \$spill, node 1 destination index (used for type SEND)
/Sctl/layer/L/\$spill1/val	I	0..127		<i>Left WING [only] layer \$spill, node 1 value (when type MIDI)</i>
/Sctl/layer/C	N			Center WING [only] layer node
/Sctl/layer/C/sel	I	1..22	1..6 settable 7..9 No-op 10..22 fixed/pre-assigned	Center WING [only] layer select <sup>54</sup> : 1: DCA 2: Main/Matrix 3: Aux/FX 4: Bus/Master 5: User 1 6: User 2 7: No-op 8: No-op 9: No-op 10: Ch 1..Ch 8 11: Ch 9..Ch 16 12: Ch 17..Ch 24 13: Ch 25..Ch 32 14: Ch 33..Ch 40 15: Aux 1..Aux 8 16: Bus 1..Bus 8 17: Bus 9..Bus 16 18: Main 1..Main 4 19: Matrix 1..Matrix 8 20: DCA 1..DCA 8 21: DCA 9..DCA 16 22: spilled layer
/Sctl/layer/C/spidx	I	0..62		Spilled group 0: OFF 1..16: DCA 1..16 17-32: FX 1..16 33-48: BUS 1..16 [TBV] 49..56: MTX 1..16 [TBV] 57..60: MAIN 1..4 [TBV] 61: AUTOX 62: AUTOY 63: SOF

<sup>53</sup> Can be set, but will likely be replaced by default names from console layer changes, such as AUTO-X, AUTO-Y, or SPILL

<sup>54</sup> Full-size console layers names

/Sctl/layer/C/1	N	1..9		Center WING [only] layer 1 node (see above)
/Sctl/layer/C/1/ofs	I	0..8		Center WING [only] layer 1 offset
/Sctl/layer/C/1/name	S		10 chars max DCA, MAIN, AUX, BUSES, USER1, USER2	Center WING [only] layer 1 name
/Sctl/layer/C/1/1	N	1..16		Center WING [only] layer 1, node 1
/Sctl/layer/C/1/1/type	S		OFF, CH, BUS, DCA, MIDI, SEND, FX	Center WING [only] layer 1, node 1 type (OSC patterns in italic below correspond to MIDI type)
/Sctl/layer/C/1/1/i	I	1..127		Center WING [only] layer 1, node 1 index
/Sctl/layer/C/1/1/dst	I	1..28		Center WING [only] layer 1, node 1 destination index (used for type SEND)
/Sctl/layer/C/1/1/val	I	0..127		<i>Center WING [only] layer 1, node 1 value (when type MIDI)</i>
/Sctl/layer/C/\$spill				Center WING [only] \$spill
/Sctl/layer/C/\$spill/ofs	I	0..64		Center WING [only] \$spill offset
/Sctl/layer/C/\$spill/name	S		10 chars max	Center WING [only] layer \$spill name <sup>55</sup>
/Sctl/layer/C/\$spill/1	N	1..76		Center WING [only] layer \$spill, node 1
/Sctl/layer/C/\$spill/1/type	S		OFF, CH, BUS, DCA, MIDI, SEND, FX	Center WING [only] layer \$spill, node 1 type (OSC patterns in italic below correspond to MIDI type)
/Sctl/layer/C/\$spill/1/i	I	1..127		Center WING [only] layer \$spill, node 1 index
/Sctl/layer/C/\$spill/1/dst	I	1..28		Center WING [only] layer \$spill, node 1 destination index (used for type SEND)
/Sctl/layer/C/\$spill/1/val	I	0..127		<i>Center WING [only] layer \$spill, node 1 value (when type MIDI)</i>
/Sctl/layer/R	N			Right WING [only] layer node
/Sctl/layer/R/sel	I	1..22	1..7 settable 8, 9 No-op 10..22 fixed/pre-assigned	Right WING [only] layer select <sup>56</sup> : 1: Main 2: DCA 3: Channels 4: Aux/FX 5: Bus/Master 6: User 1 7: User 2 8: No-op 9: No-op 10: Ch 1..Ch 4 11: Ch 9..Ch 12 12: Ch 17..Ch 20 13: Ch 25..Ch 28 14: Ch 33..Ch 36 15: Aux 1..Aux 4 16: Bus 1..Bus 4 17: Bus 9..Bus 12 18: Main 1..Main 4 19: Matrix 1..Matrix 4 20: DCA 1..DCA 4

<sup>55</sup> Can be set, but will likely be replaced by default names from console layer changes, such as AUTO-X, AUTO-Y, or SPILL

<sup>56</sup> Full-size console layers names

				21: DCA 9..DCA 12 22: spilled layer
/Sctl/layer/R/spidx	I	0..63		Spilled group 0: OFF 1..16: DCA 1..16 17-32: FX 1..16 33-48: BUS 1..16 [TBV] 49..56: MTX 1..16 [TBV] 57..60: MAIN 1..4 [TBV] 61: AUTOX 62: AUTOY 63: SOF
/Sctl/layer/R/1	N	1..9		Right WING [only] layer 1 node (see above)
/Sctl/layer/R/1/ofs	I	0..15		Right WING [only] layer 1 offset
/Sctl/layer/R/1/name	S		MAIN, DCA, CH1-40, AUX, BUSES, USER1, USER2	Right WING [only] layer 1 name
/Sctl/layer/R/1/1	N	1..16 (40 for... /R/3...)		Right WING [only] layer 1, node 1. 16 nodes except for type CH1-40: 40 nodes
/Sctl/layer/R/1/1/type	S		OFF, CH, BUS, DCA, MIDI, SEND, FX	Right WING [only] layer 1, node 1 type (OSC patterns in italic below correspond to MIDI type)
/Sctl/layer/R/1/1/i	I	0..127		Right WING [only] layer 1, node 1 index
/Sctl/layer/R/1/1/dst	I	1..28		Right WING [only] layer 1, node 1 destination index (used for type SEND)
/Sctl/layer/R/1/1/val	I	0..127		<i>Right WING [only] layer 1, node 1 value (when type MIDI)</i>
/Sctl/layer/R/\$spill				<i>Right WING [only] \$spill</i>
/Sctl/layer/R/\$spill/ofs	I	0..64		<i>Right WING [only] \$spill offset</i>
/Sctl/layer/R/\$spill/name	S		10 chars max	<i>Right WING [only] layer \$spill name<sup>57</sup></i>
/Sctl/layer/R/\$spill/1	N	1..76		<i>Right WING [only] layer \$spill, node 1</i>
/Sctl/layer/R/\$spill/1/type	S		OFF, CH, BUS, DCA, MIDI, SEND, FX	<i>Right WING [only] layer \$spill, node 1 type (OSC patterns in italic below correspond to MIDI type)</i>
/Sctl/layer/R/\$spill/1/i	I	1..127		<i>Right WING [only] layer \$spill, node 1 index</i>
/Sctl/layer/R/\$spill/1/dst	I	1..28		<i>Right WING [only] layer \$spill, node 1 destination index (used for type SEND)</i>
/Sctl/layer/R/\$spill/1/val	I	0..127		<i>Right WING [only] layer \$spill, node 1 value (when type MIDI)</i>
/Sctl/layer/CMPCT				
/Sctl/layer/CMPCT/sel	I	1..22	1..7 settable 8..22 [TBV]	Compact [only] layer select <sup>58</sup> 1: Ch 1..Ch 12 2: Ch 13..Ch 24 3: Ch 25..Ch 36 4: Ch 36..Ch 40 / Aux 1..Aux 8 5: Bus 1..Bus 12 6: User 1

<sup>57</sup> Can be set, but will likely be replaced by default names from console layer changes, such as AUTO-X, AUTO-Y, or SPILL

<sup>58</sup> Compact console layers names

				7: User 2 8..21: [TBV] 22: spilled layer
/\${ctl}/layer/CMPCT/spidx	I	0..63		Spilled group 0: OFF 1..16: DCA 1..16 17-32: FX 1..16 33-48: BUS 1..16 [TBV] 49..56: MTX 1..16 [TBV] 57..60: MAIN 1..4 [TBV] 61: AUTOX 62: AUTOY 63: SOF
/\${ctl}/layer/CMPCT/1	N	1..9		Compact [only] layer 1 node (see above)
/\${ctl}/layer/CMPCT/1/ofs	I	0..12		Compact [only] layer 1 offset
/\${ctl}/layer/CMPCT/1/name	S		10 chars max CH1-12, CH13-24, CH25-36, CH37-AUX, BUSES, ... [TBV]	Compact [only] layer 1 name
/\${ctl}/layer/CMPCT/1/1	N	1..24		Compact [only] layer 1, node 1
/\${ctl}/layer/CMPCT/1/1/type	S		OFF, CH, BUS, DCA, MIDI, SEND, FX	Compact [only] layer 1, node 1 type (OSC patterns in italic below correspond to MIDI type)
/\${ctl}/layer/CMPCT/1/1/i	I	1..127		Compact [only] layer 1, node 1 index
/\${ctl}/layer/CMPCT/1/1/dst	I	1..28		Compact [only] layer 1, node 1 destination index (used for type SEND)
/\${ctl}/layer/CMPCT/1/1/val	I	0..127		Compact [only] <i>layer 1, node 1 value (when type MIDI)</i>
/\${ctl}/layer/CMPCT/\$\$spill				Compact WING [only] \$\$spill
/\${ctl}/layer/CMPCT/\$\$spill/ofs	I	0..64		Compact WING [only] \$\$spill offset
/\${ctl}/layer/CMPCT/\$\$spill/name	S		10 chars max	Compact WING [only] layer \$\$spill name <sup>59</sup>
/\${ctl}/layer/CMPCT/\$\$spill/1	N	1..76		Compact WING [only] layer \$\$spill, node 1
/\${ctl}/layer/CMPCT/\$\$spill/1/type	S		OFF, CH, BUS, DCA, MIDI, SEND, FX	Compact WING [only] layer \$\$spill, node 1 type (OSC patterns in italic below correspond to MIDI type)
/\${ctl}/layer/CMPCT/\$\$spill/1/i	I	1..127		Compact WING [only] layer \$\$spill, node 1 index
/\${ctl}/layer/CMPCT/\$\$spill/1/dst	I	1..28		Compact WING [only] layer \$\$spill, node 1 destination index (used for type SEND)
/\${ctl}/layer/CMPCT/\$\$spill/1/val	I	0..127		Compact WING [only] <i>layer \$\$spill, node 1 value (when type MIDI)</i>
/\${ctl}/layer/RCK				
/\${ctl}/layer/RCK/sel	I	1..22	1..7 settable 8..22 [TBV]	Rack [only] layer select <sup>60</sup> 1: Ch 1..Ch 12 2: Ch 13..Ch 24 3: Ch 25..Ch 36 4: Ch 36..Ch 40 / Aux 1..Aux 8 5: Bus 1..Bus 12

<sup>59</sup> Can be set, but will likely be replaced by default names from console layer changes, such as AUTO-X, AUTO-Y, or SPILL

<sup>60</sup> Rack console layers names

				6: User 1 7: User 2 8..21: [TBV] 22: spilled layer
/Sctl/layer/RCK/spidx	I	0..63		Spilled group 0: OFF 1..16: DCA 1..16 17-32: FX 1..16 33-48: BUS 1..16 [TBV] 49..56: MTX 1..16 [TBV] 57..60: MAIN 1..4 [TBV] 61: AUTOX 62: AUTOY 63: SOF
/Sctl/layer/RCK/1	N	1..5		Rack [only] layer 1 node (see above)
/Sctl/layer/RCK/1/ofs	I	0..36		Rack [only] layer 1 offset
/Sctl/layer/RCK/1/name	S		10 chars max CH1-12, CH13-24, CH25-36, CH37-AUX, BUSES, ... [TBV]	Rack [only] layer 1 name
/Sctl/layer/RCK/1/1	N	1..40		Rack [only] layer 1, node 1
/Sctl/layer/RCK/1/1/type	S		OFF, CH, BUS, DCA, MIDI, SEND, FX	Rack [only] layer 1, node 1 type (OSC patterns in italic below correspond to MIDI type)
/Sctl/layer/RCK/1/1/i	I	1..127		Rack [only] layer 1, node 1 index
/Sctl/layer/RCK/1/1/dst	I	1..28		Rack [only] layer 1, node 1 destination index (used for type SEND)
/Sctl/layer/RCK/1/1/val	I	0..127		Rack [only] <i>layer 1, node 1 value (when type MIDI)</i>
/Sctl/layer/RCK/\$spill				Rack WING [only] \$spill
/Sctl/layer/RCK/\$spill/ofs	I	0..64		Rack WING [only] \$spill offset
/Sctl/layer/RCK/\$spill/name	S		10 chars max	Rack WING [only] layer \$spill name <sup>61</sup>
/Sctl/layer/RCK/\$spill/1	N	1..76		Rack WING [only] layer \$spill, node 1
/Sctl/layer/RCK/\$spill/1/type	S		OFF, CH, BUS, DCA, MIDI, SEND, FX	Rack WING [only] layer \$spill, node 1 type (OSC patterns in italic below correspond to MIDI type)
/Sctl/layer/RCK/\$spill1/i	I	1..127		Rack WING [only] layer \$spill, node 1 index
/Sctl/layer/RCK/\$spill1/dst	I	1..28		Rack WING [only] layer \$spill, node 1 destination index (used for type SEND)
/Sctl/layer/RCK/\$spill1/val	I	0..127		Rack WING [only] <i>layer \$spill, node 1 value (when type MIDI)</i>
/Sctl/layer/EXT				
/Sctl/layer/EXT/sel	I	1..22	1..7 settable 8..22 [TBV]	Extern [only] layer select <sup>62</sup> 1: Ch 1..Ch 12 2: Ch 13..Ch 24 3: Ch 25..Ch 36 4: Ch 36..Ch 40 / Aux 1..Aux 8 5: Bus 1..Bus 12 6: User 1

<sup>61</sup> Can be set, but will likely be replaced by default names from console layer changes, such as AUTO-X, AUTO-Y, or SPILL

<sup>62</sup> Ext console layers names [TBV]

				7: User 2 8..21: [TBV] 22: spilled layer
/Sctl/layer/EXT/spidx	I	0..62		Spilled group 0: OFF 1..16: DCA 1..16 17-32: FX 1..16 33-48: BUS 1..16 [TBV] 49..56: MTX 1..16 [TBV] 57..60: MAIN 1..4 [TBV] 61: AUTOX 62: AUTOY
/Sctl/layer/EXT/1	N	1..8		Extern [only] layer 1 node (see above)
/Sctl/layer/EXT/1/ofs	I	0..8		Extern [only] layer 1 offset
/Sctl/layer/EXT/1/name	S		10 chars max ... [TBV]	Extern [only] layer 1 name
/Sctl/layer/EXT/1/1	N	1..16		Extern [only] layer 1, node 1
/Sctl/layer/EXT/1/1/type	S		OFF, CH, BUS, DCA, MIDI, SEND, FX	Extern [only] layer 1, node 1 type (OSC patterns in italic below correspond to MIDI type)
/Sctl/layer/EXT/1/1/i	I	1..127		Extern [only] layer 1, node 1 index
/Sctl/layer/EXT/1/1/dst	I	1..28		Extern [only] layer 1, node 1 destination index (used for type SEND)
/Sctl/layer/EXT/1/1/val	I	0..127		Extern [only] <i>layer 1, node 1 value (when type MIDI)</i>
/Sctl/layer/EXT/\$spill				Extern WING [only] \$spill
/Sctl/layer/EXT/\$spill/ofs	I	0..64		Extern WING [only] \$spill offset
/Sctl/layer/EXT/\$spill/name	S		10 chars max	Extern WING [only] layer \$spill name <sup>63</sup>
/Sctl/layer/EXT/\$spill/1	N	1..76		Extern WING [only] layer \$spill, node 1
/Sctl/layer/EXT/\$spill/1/type	S		OFF, CH, BUS, DCA, MIDI, SEND, FX	Extern WING [only] layer \$spill, node 1 type (OSC patterns in italic below correspond to MIDI type)
/Sctl/layer/EXT/\$spill1/i	I	1..127		Extern WING [only] layer \$spill, node 1 index
/Sctl/layer/EXT/\$spill1/dst	I	1..28		Extern WING [only] layer \$spill, node 1 destination index (used for type SEND)
/Sctl/layer/EXT/\$spill1/val	I	0..127		Extern WING [only] <i>layer \$spill, node 1 value (when type MIDI)</i>
/Sctl/layer/VRT				
/Sctl/layer/VRT/sel	I	1..22	1..7 settable 8..22 [TBV]	Virtual [only] layer select <sup>64</sup> 1: Ch 1..Ch 12 2: Ch 13..Ch 24 3: Ch 25..Ch 36 4: Ch 36..Ch 40 / Aux 1..Aux 8 5: Bus 1..Bus 12 6: User 1 7: User 2 8..21: [TBV] 22: spilled layer

<sup>63</sup> Can be set, but will likely be replaced by default names from console layer changes

<sup>64</sup> VRT console layers names [TBV]

/Sctl/layer/VRT/spidx	I	0..62		Spilled group 0: OFF 1..16: DCA 1..16 17-32: FX 1..16 33-48: BUS 1..16 [TBV] 49..56: MTX 1..16 [TBV] 57..60: MAIN 1..4 [TBV] 61: AUTOX 62: AUTOY
/Sctl/layer/VRT/1	N	1..8		Virtual [only] layer 1 node (see above)
/Sctl/layer/VRT/1/ofs	I	0..8		Virtual [only] layer 1 offset
/Sctl/layer/VRT/1/name	S		10 chars max ... [TBV]	Virtual [only] layer 1 name
/Sctl/layer/VRT/1/1	N	1..16		Virtual [only] layer 1, node 1
/Sctl/layer/VRT/1/1/type	S		OFF, CH, BUS, DCA, MIDI, SEND, FX	Virtual [only] layer 1, node 1 type (OSC patterns in italic below correspond to MIDI type)
/Sctl/layer/VRT/1/1/i	I	1..127		Virtual [only] layer 1, node 1 index
/Sctl/layer/VRT/1/1/dst	I	1..28		Virtual [only] layer 1, node 1 destination index (used for type SEND)
/Sctl/layer/VRT/1/1/val	I	0..127		Virtual [only] <i>layer 1, node 1 value (when type MIDI)</i>
/Sctl/layer/VRT/\$spill				Virtual WING [only] \$spill
/Sctl/layer/VRT/\$spill/ofs	I	0..64		Virtual WING [only] \$spill offset
/Sctl/layer/VRT/\$spill/name	S		10 chars max	Virtual WING [only] layer \$spill name <sup>65</sup>
/Sctl/layer/VRT/\$spill/1	N	1..76		Virtual WING [only] layer \$spill, node 1
/Sctl/layer/VRT/\$spill/1/type	S		OFF, CH, BUS, DCA, MIDI, SEND, FX	Virtual WING [only] layer \$spill, node 1 type (OSC patterns in italic below correspond to MIDI type)
/Sctl/layer/VRT/\$spill/1/i	I	1..127		Virtual WING [only] layer \$spill, node 1 index
/Sctl/layer/VRT/\$spill/1/dst	I	1..28		Virtual WING [only] layer \$spill, node 1 destination index (used for type SEND)
/Sctl/layer/VRT/\$spill/1/val	I	0..127		Virtual WING [only] <i>layer \$spill, node 1 value (when type MIDI)</i>
/Sctl/user	N			User node
/Sctl/user/sel	I	1..16		User select <sup>66</sup>
/Sctl/user/mode	S		USER, 2TRK, WLIVE, MGRP, SHOW	User button mode (5 buttons above the wheel on the full-size console)
/Sctl/user/cmode	S		HA, GATE, COMP, FLT, U1, U2, U3, PAN	User channel mode (8 buttons top right corner of the full-size console)
/Sctl/user/gpio	N			User GPIO node
/Sctl/user/gpio/1	N	1..4		User GPIO 1 node
/Sctl/user/gpio/1/bu	N			User GPIO 1 up node
/Sctl/user/gpio/1/bu/mode	S		OFF, MUTE, SOLO, INS1, INS2, MGRP, DCAMUTE,	User GPIO 1 up function (see appendix on buttons)

<sup>65</sup> Can be set, but will likely be replaced by default names from console layer changes

<sup>66</sup> Setting values using the range 1..16, reported int values are in the range 0..15, string values in the range 1..16



			SOF, SPILL, FXPAR, DAWBTN, DAWENC, CHPAGE, PAGE, FDRPAGE, VIEWPAGE, OTHER, GPIO, FSTART, SHOWCTL, SCENES, MIDICCT, MIDICCP, MIDINT, MIDINP, MIDIPGM, USBPR, SDRECA, SESSIONA, MARKERA, SDRECB, SESSIONB, MARKERB	
/\${ctl}/user/gpio/1/bu/name	S		16 chars max	User GPIO 1 up name (use a leading ' ' to invert characters)
/\${ctl}/user/gpio/1/bu/\$fname	S		16 chars max	User GPIO 1 up \$fname [RO]
/\${ctl}/user/user	N			User Layer node (bottom with Link enabled)
/\${ctl}/user/user/1	N	1..4		User layer button 1 node
/\${ctl}/user/user/1/bu	N			User layer button 1 upper row node
/\${ctl}/user/user/1/bu/mode	S		OFF, MUTE, SOLO, INS1, INS2, MGRP, DCAMUTE, SOF, SPILL, FXPAR, DAWBTN, DAWENC, CHPAGE, PAGE, FDRPAGE, VIEWPAGE, OTHER, GPIO, FSTART, SHOWCTL, SCENES, MIDICCT, MIDICCP, MIDINT, MIDINP, MIDIPGM, USBPR, SDRECA, SESSIONA, MARKERA, SDRECB, SESSIONB, MARKERB	User layer button1 upper row function (see appendix on buttons)
/\${ctl}/user/user/1/bu/name	S		16 chars max	User layer button 1 upper row name (use a leading ' ' to invert characters)
/\${ctl}/user/user/1/bu/\$fname	S		16 chars max	User layer button 1 upper row function name [RO]
/\${ctl}/user/user/1/bd	N			User layer button 1 lower row node
/\${ctl}/user/user/1/bd/mode	S		OFF, MUTE, SOLO, INS1, INS2, MGRP, DCAMUTE, SOF, SPILL, FXPAR, DAWBTN, DAWENC, CHPAGE, PAGE, FDRPAGE, VIEWPAGE, OTHER, GPIO, FSTART, SHOWCTL, SCENES, MIDICCT, MIDICCP, MIDINT, MIDINP, MIDIPGM, USBPR, SDRECA, SESSIONA, MARKERA, SDRECB, SESSIONB, MARKERB	User layer button 1 lower row function (see appendix on buttons)
/\${ctl}/user/user/1/bd/name	S		16 chars max	User layer button 1 lower row name (use a leading ' ' to invert characters)
/\${ctl}/user/user/1/bd/\$fname	S		16 chars max	User layer button 1 lower row function name [RO]
/\${ctl}/user/daw1	N			User DAW1 node
/\${ctl}/user/daw1/1	N	1..4		User DAW1 button 1 node
/\${ctl}/user/daw1/1/bu	N			User DAW1 button 1 upper row node

<i>/\${ctl}/user/daw1/1/bu/mode</i>	S		OFF, MUTE, SOLO, INS1, INS2, MGRP, DCAMUTE, SOF, SPILL, FXPAR, DAWBTN, DAWENC, CHPAGE, PAGE, FDRPAGE, VIEWPAGE, OTHER, GPIO, FSTART, SHOWCTL, SCENES, MIDICCT, MIDICCP, MIDINT, MIDINP, MIDIPGM, USBPR, SDRECA, SESSIONA, MARKERA, SDRECB, SESSIONB, MARKERB	User DAW1 button 1 upper row function (see appendix on buttons)
<i>/\${ctl}/user/daw1/1/bu/name</i>	S		16 chars max	User DAW1 button 1 upper row name (use a leading ' ' to invert characters)
<i>/\${ctl}/user/daw1/1/bu/\${fname}</i>	S		16 chars max	User DAW1 button 1 upper row function name [RO]
<i>/\${ctl}/user/daw1/1/bd</i>	N			User DAW1 button 1 lower row node
<i>/\${ctl}/user/daw1/1/bd/mode</i>	S		OFF, MUTE, SOLO, INS1, INS2, MGRP, DCAMUTE, SOF, SPILL, FXPAR, DAWBTN, DAWENC, CHPAGE, PAGE, FDRPAGE, VIEWPAGE, OTHER, GPIO, FSTART, SHOWCTL, SCENES, MIDICCT, MIDICCP, MIDINT, MIDINP, MIDIPGM, USBPR, SDRECA, SESSIONA, MARKERA, SDRECB, SESSIONB, MARKERB	User DAW1 button 1 lower row function (see appendix on buttons)
<i>/\${ctl}/user/daw1/1/bd/name</i>	S		16 chars max	User DAW1 button 1 lower row name (use a leading ' ' to invert characters)
<i>/\${ctl}/user/daw1/1/bd/\${fname}</i>	S		16 chars max	User DAW1 button 1 lower row function name [RO]
<i>/\${ctl}/user/daw2</i>	N			User DAW2 node
<i>/\${ctl}/user/daw2/1</i>	N	1..4		User DAW2 button 1 node
<i>/\${ctl}/user/daw2/1/bu</i>	N			User DAW2 button 1 upper row node
<i>/\${ctl}/user/daw2/1/bu/mode</i>	S		OFF, MUTE, SOLO, INS1, INS2, MGRP, DCAMUTE, SOF, SPILL, FXPAR, DAWBTN, DAWENC, CHPAGE, PAGE, FDRPAGE, VIEWPAGE, OTHER, GPIO, FSTART, SHOWCTL, SCENES, MIDICCT, MIDICCP, MIDINT, MIDINP, MIDIPGM, USBPR, SDRECA, SESSIONA, MARKERA, SDRECB, SESSIONB, MARKERB	User DAW2 button 1 upper row function (see appendix on buttons)
<i>/\${ctl}/user/daw2/1/bu/name</i>	S		16 chars max	User DAW2 button 1 upper row name (use a leading ' ' to invert characters)
<i>/\${ctl}/user/daw2/1/bu/\${fname}</i>	S		16 chars max	User DAW2 button 1 upper row function name [RO]
<i>/\${ctl}/user/daw2/1/bd</i>	N			User DAW2 button 1 lower row node

/\${ctl}/user/daw2/1/bd/mode	S		OFF, MUTE, SOLO, INS1, INS2, MGRP, DCAMUTE, SOF, SPILL, FXPAR, DAWBTN, DAWENC, CHPAGE, PAGE, FDRPAGE, VIEWPAGE, OTHER, GPIO, FSTART, SHOWCTL, SCENES, MIDICCT, MIDICCP, MIDINT, MIDINP, MIDIPGM, USBPR, SDRECA, SESSIONA, MARKERA, SDRECB, SESSIONB, MARKERB	User DAW2 button 1 lower row function (see appendix on buttons)
/\${ctl}/user/daw2/1/bd/name	S		16 chars max	User DAW2 button 1 lower row name (use a leading ' ' to invert characters)
/\${ctl}/user/daw2/1/bd/\${fname}	S		16 chars max	User DAW2 button 1 lower row function name [RO]
/\${ctl}/user/daw3	N			User DAW3 node
/\${ctl}/user/daw3/1	N	1..4		User DAW3 button 1 node
/\${ctl}/user/daw3/1/bu	N			User DAW3 button 1 upper row node
/\${ctl}/user/daw3/1/bu/mode	S		OFF, MUTE, SOLO, INS1, INS2, MGRP, DCAMUTE, SOF, SPILL, FXPAR, DAWBTN, DAWENC, CHPAGE, PAGE, FDRPAGE, VIEWPAGE, OTHER, GPIO, FSTART, SHOWCTL, SCENES, MIDICCT, MIDICCP, MIDINT, MIDINP, MIDIPGM, USBPR, SDRECA, SESSIONA, MARKERA, SDRECB, SESSIONB, MARKERB	User DAW3 button 1 upper row function (see appendix on buttons)
/\${ctl}/user/daw3/1/bu/name	S		16 chars max	User DAW3 button 1 upper row name (use a leading ' ' to invert characters)
/\${ctl}/user/daw3/1/bu/\${fname}	S		16 chars max	User DAW3 button 1 upper row function name [RO]
/\${ctl}/user/daw3/1/bd	N			User DAW3 button 1 lower row node
/\${ctl}/user/daw3/1/bd/mode	S		OFF, MUTE, SOLO, INS1, INS2, MGRP, DCAMUTE, SOF, SPILL, FXPAR, DAWBTN, DAWENC, CHPAGE, PAGE, FDRPAGE, VIEWPAGE, OTHER, GPIO, FSTART, SHOWCTL, SCENES, MIDICCT, MIDICCP, MIDINT, MIDINP, MIDIPGM, USBPR, SDRECA, SESSIONA, MARKERA, SDRECB, SESSIONB, MARKERB	User DAW3 button 1 lower row function (see appendix on buttons)
/\${ctl}/user/daw3/1/bd/name	S		16 chars max	User DAW3 button 1 lower row name (use a leading ' ' to invert characters)
/\${ctl}/user/daw3/1/bd/\${fname}	S		16 chars max	User DAW3 button 1 lower row function name [RO]
/\${ctl}/user/daw4	N			User DAW4 node

/\${ctl}/user/daw4/1	N			User DAW4 button 1 node
/\${ctl}/user/daw4/1/bu	N	1..4		User DAW4 button 1 upper row node
/\${ctl}/user/daw4/1/bu/mode	S		OFF, MUTE, SOLO, INS1, INS2, MGRP, DCAMUTE, SOF, SPILL, FXPAR, DAWBTN, DAWENC, CHPAGE, PAGE, FDRPAGE, VIEWPAGE, OTHER, GPIO, FSTART, SHOWCTL, SCENES, MIDICCT, MIDICCP, MIDINT, MIDINP, MIDIPGM, USBPR, SDRECA, SESSIONA, MARKERA, SDRECB, SESSIONB, MARKERB	User DAW4 button 1 upper row function (see appendix on buttons)
/\${ctl}/user/daw4/1/bu/name	S		16 chars max	User DAW4 button 1 upper row name (use a leading ' ' to invert characters)
/\${ctl}/user/daw4/1/bu/\${fname}	S		16 chars max	User DAW4 button 1 upper row function name [RO]
/\${ctl}/user/daw4/1/bd	N			User DAW4 button 1 lower row node
/\${ctl}/user/daw4/1/bd/mode	S		OFF, MUTE, SOLO, INS1, INS2, MGRP, DCAMUTE, SOF, SPILL, FXPAR, DAWBTN, DAWENC, CHPAGE, PAGE, FDRPAGE, VIEWPAGE, OTHER, GPIO, FSTART, SHOWCTL, SCENES, MIDICCT, MIDICCP, MIDINT, MIDINP, MIDIPGM, USBPR, SDRECA, SESSIONA, MARKERA, SDRECB, SESSIONB, MARKERB	User DAW4 button 1 lower row function (see appendix on buttons)
/\${ctl}/user/daw4/1/bd/name	S		16 chars max	User DAW4 button 1 lower row name (use a leading ' ' to invert characters)
/\${ctl}/user/daw4/1/bd/\${fname}	S		16 chars max	User DAW4 button 1 lower row function name [RO]
/\${ctl}/user/1	N	1..16, U1..U4, MM, D1..D4		User 1 node <sup>67</sup>
/\${ctl}/user/1/1	N	1..4		User 1 button/encoder 1 node
/\${ctl}/user/1/1/led	I	0..1		User 1 LED 1 off/on switch
/\${ctl}/user/1/1/col	I	1..12		User 1 LED 1 color
/\${ctl}/user/1/1/enc	N			User 1 encoder 1 node <sup>68</sup>
/\${ctl}/user/1/1/enc/mode	S		OFF, FDR, PAN, DCA, SSND, FSND, FX, DAWMCU, MON, OTHER, MIDICC, SD A, SD B	User 1 encoder 1 function (see appendix on buttons)
/\${ctl}/user/1/1/enc/name	S		16 chars max	User 1 encoder 1 name (use a leading ' ' to invert characters, use a leading '*' to ensure value is displayed, or ' *' for both actions)

<sup>67</sup> Some /\${ctl}/user/xx values [i.e U1..4, MM, D1..4] are specific to Compact (U1..4: User, MM: Main/Matrix, D1..4: DCA)

<sup>68</sup> Not valid on Compact models

/§ctl/user/1/1/enc/§fname	S		16 chars max	User 1 encoder 1 function name [RO]
/§ctl/user/1/1/1/bu	N			User 1 button 1 upper row node
/§ctl/user/1/1/1/bu/mode	S		OFF, MUTE, SOLO, INS1, INS2, MGRP, DCAMUTE, SOF, SPILL, FXPAR, DAWBTN, DAWENC, CHPAGE, PAGE, FDRPAGE, VIEWPAGE, OTHER, GPIO, FSTART, SHOWCTL, SCENES, MIDICCT, MIDICCP, MIDINT, MIDINP, MIDIPGM, USBPR, SDRECA, SESSIONA, MARKERA, SDRECB, SESSIONB, MARKERB	User 1 button 1 upper row function (see appendix on buttons)
/§ctl/user/1/1/1/bu/name	S		16 chars max	User 1 button 1 upper row name (use a leading bu/mode'  ' to invert characters)
/§ctl/user/1/1/1/bu/§fname	S		16 chars max	User 1 button 1 upper row function name [RO]
/§ctl/user/1/1/1/bd	N			User 1 button 1 lower row node <sup>69</sup>
/§ctl/user/1/1/1/bd/mode	S		OFF, MUTE, SOLO, INS1, INS2, MGRP, DCAMUTE, SOF, SPILL, FXPAR, DAWBTN, DAWENC, CHPAGE, PAGE, FDRPAGE, VIEWPAGE, OTHER, GPIO, FSTART, SHOWCTL, SCENES, MIDICCT, MIDICCP, MIDINT, MIDINP, MIDIPGM, USBPR, SDRECA, SESSIONA, MARKERA, SDRECB, SESSIONB, MARKERB	User 1 button 1 lower row function (see appendix on buttons)
/§ctl/user/1/1/1/bd/name	S		16 chars max	User 1 button 1 lower row name (use a leading '  ' to invert characters)
/§ctl/user/1/1/1/bd/§fname	S		16 chars max	User 1 button 1 lower row function name [RO]
/§ctl/user/cuser	N	1..3		Cuser node
/§ctl/user/cuser/1	S		1, 2, 3, ... , 23, 24	Cuser 1 rotary knob position; Keeps the bus send value assigned to respective channel for the F1..F3 section. Can be set/changed by holding the F1..F3 key and turning the knob.
/§ctl/gpio	N			GPIO node
/§ctl/gpio/1	N	1.4		GPIO 1 node
/§ctl/gpio/1/mode	S		TGLNO, TGLNC, INNO, INNC, OUTNO, OUTNC	GPIO 1 mode (TGL: toggle; NO: normally open; NC: normally closed)
/§ctl/gpio/1/§state	I	0..1		GPIO 1 state [RO]
/§ctl/gpio/1/gpstate	I	0..1		GPIO 1 gpio state
/§ctl/safes	N			Global Safes node
/§ctl/safes/ch	S		40 chars max	Ch safes switches (+ or space)

<sup>69</sup> Not valid on Compact models

/Sctl/safes/aux	S		8 chars max	Aux safes switches (+ or space)
/Sctl/safes/bus	S		16 chars max	Bus safes switches (+ or space)
/Sctl/safes/main	S		4 chars max	Main safes switches (+ or space)
/Sctl/safes/mtx	S		8 chars max	Matrix safes switches (+ or space)
/Sctl/safes/dca	S		16 chars max	DCA safes switches (+ or space)
/Sctl/safes/mute	S		8 chars max	Mute safes switches (+ or space)
/Sctl/safes/fx	S		16 chars max	FX safes switches (+ or space)
/Sctl/safes/source	N			Source Safes node
/Sctl/safes/source/LCL	S		24 chars max	LCL source safes switches (+ or space)
/Sctl/safes/source/AUX	S		8 chars max	AUX source safes switches (+ or space)
/Sctl/safes/source/A	S		48 chars max	A source safes switches (+ or space)
/Sctl/safes/source/B	S		48 chars max	B source safes switches (+ or space)
/Sctl/safes/source/C	S		48 chars max	C source safes switches (+ or space)
/Sctl/safes/source/SC	S		32 chars max	SC source safes switches (+ or space)
/Sctl/safes/source/USB	S		48 chars max	USB source safes switches (+ or space)
/Sctl/safes/source/CRD	S		64 chars max	CRD source safes switches (+ or space)
/Sctl/safes/source/MOD	S		64 chars max	MOD source safes switches (+ or space)
/Sctl/safes/source/PLAY	S		4 chars max	REC source safes switches (+ or space)
/Sctl/safes/source/AES	S		2 chars max	AES source safes switches (+ or space)
/Sctl/safes/source/USR	S		48 chars max	USR source safes switches (+ or space)
/Sctl/safes/source/OSC	S		2 chars max	Osc source safes switches (+ or space)
/Sctl/safes/output	N			Output Safes node
/Sctl/safes/output/LCL	S		8 chars max	LCL out safes switches (+ or space)
/Sctl/safes/output/AUX	S		8 chars max	AUX out safes switches (+ or space)
/Sctl/safes/output/A	S		48 chars max	A out safes switches (+ or space)
/Sctl/safes/output/B	S		48 chars max	B out safes switches (+ or space)
/Sctl/safes/output/C	S		48 chars max	C out safes switches (+ or space)
/Sctl/safes/output/SC	S		32 chars max	SC out safes switches (+ or space)
/Sctl/safes/output/USB	S		48 chars max	USB out safes switches (+ or space)
/Sctl/safes/output/CRD	S		64 chars max	CRD out safes switches (+ or space)
/Sctl/safes/output/MOD	S		64 chars max	MOD out safes switches (+ or space)
/Sctl/safes/output/REC	S		4 chars max	REC out safes switches (+ or space)
/Sctl/safes/output/AES	S		2 chars max	AES out safes switches (+ or space)
/Sctl/safes/area	N			Area safes node
/Sctl/safes/area/LEFT	S		7 chars max	Left area safes switches (+ or space)
/Sctl/safes/area/CENTER	S		6 chars max	Center area safes switches (+ or space)
/Sctl/safes/area/RIGHT	S		7 chars max	Right area safes switches (+ or space)
/Sctl/safes/area/COMPACT	S		9 chars max	Compact area safes switches (+ or space)
/Sctl/safes/area/RACK	S		5 chars max	Rack area safes switches (+ or space)
/Sctl/safes/area/EXTERN	S		8 chars max	Extern area safes switches (+ or space)
/Sctl/safes/area/VIRTUAL	S		8 chars max	Virtual area safes switches (+ or space)
/Sctl/safes/custom	S		31 chars max	Custom area safes switches (+ or space)
/Sctl/safes/setup	S		3 chars max	Setup area safes switches (+ or space)
/Sctl/daw	N			DAW node
/Sctl/daw/on	I	0..1		DAW enable
/Sctl/daw/conn	S		DIN, USB	DAW connection
/Sctl/daw/emul	S		MCU, HUI	DAW emulation

/\$/ctl/daw/config	S		CC, MSTR, MSTR1EXT, MSTR2EXT	DAW configuration
/\$/ctl/daw/ccup	I	0..1		DAW use upper cc
/\$/ctl/daw/disjog	I	0..1		DAW disable wheel during play
/\$/ctl/daw/preset	S		-, cubase, live, logicx, nuendo, protocols, reaper, studioone	DAW last loaded preset
/\$/ctl/daw/\$on	I	0..1		DAW enable switch
/\$/ctl/daw/\$bpage	I	0..4		DAW on button page
/\$/ctl/daw/\$bntouch	I	0..1		DAW on button sel fader touch
/\$/ctl/daw/\$btnvpot	I	0..1		DAW on button sel vpot
/\$/ctl/daw/\$btnrecrdy	I	0..1		DAW on button sel record ready
/\$/ctl/daw/\$btnauto	I	0..1		DAW on button sel auto
/\$/ctl/daw/\$btnvsel	I	0..1		DAW on button sel v-sel
/\$/ctl/daw/\$btninsert	I	0..1		DAW on button sel insert
/\$/ctl/midi	N			Midi node
/\$/ctl/midi/enchctl	S		OFF, DIN, USB	Channel control (FDR, MUTE, PAN)
/\$/ctl/midi/enfxctl	S		OFF, DIN, USB	FX parameter control
/\$/ctl/midi/encustctl	S		OFF, DIN, USB	Custom control (RX only)
/\$/ctl/midi/ensysex	S		OFF, DIN, USB	SYSEX control
/\$/ctl/midi/enmidicc	S		OFF, DIN, USB	External MIDI control
/\$/ctl/midi/enscenes	S		OFF, DIN, USB	Scene change
/\$/ctl/midi/enshowctl	S		OFF, DIN, USB	Show control
/\$/ctl/midi/enscenetx	S		OFF, DIN, USB	Scene MIDI TX
/\$/ctl/OSC	N			OSC node
/\$/ctl/OSC/ronly	I	0..1		Console OSC read only switch
/\$/ctl/lib	N			Library node (Shows, Scenes, Snaps, ...)
/\$/ctl/lib/\$scenes	S		Ex: scene_1, scene_2, scene_3	List of Scene <sup>70</sup> names [RO] <sup>71</sup> in the currently opened show
/\$/ctl/lib/\$actidx	I	0..n		Scene number currently loaded/active [RO] <sup>72</sup>
/\$/ctl/lib/\$active	S		256 chars max	Name of the active scene [RO], ex: <b>I:SHOW2/scene_1.snap</b>
/\$/ctl/lib/\$actshow	S		256 chars max	Name of the active show [RO], after having pressed on the "OPEN SHOW" icon, ex: <b>I:SHOW2</b>
/\$/ctl/lib/\$action	S		IDLE, GOPREV, GONEXT, GO, PREV, NEXT, GOTAG	Show control actions, after having pressed on the "OPEN SHOW" icon <sup>73</sup>
/\$/ctl/lib/\$actionidx	I	0..16384		Scene index user selection, in the list of Scenes. A show must be opened. Use <b>/\$ctl/lib/\$action ,s GO</b> to load the Scene entity <b>\$actionidx</b> points to. <b>\$actionidx</b> should be 0 to enable <b>NEXT</b> or <b>PREV</b> to work as expected with a <b>GO</b> command.
/\$/ctl/\$globals	N			CTL Global Settings node

<sup>70</sup> A Scene is a Snap, a Snippet, a Preset, an Audio clip, or a combination thereof, referenced in a Show file

<sup>71</sup> Only the first name of the list is returned by std OSC command. You must use the node definition command (OSC or native interface). To get the full contents, for ex: **/\$ctl/lib~~,s~~?~..**. A show must be opened for the command to be active

<sup>72</sup> A show must be opened for the command to be active. 0 means "no show Scene loaded"

<sup>73</sup> Make sure **/\$ctl/lib/\$actionidx** is set to 0 if you want to use **NEXT** or **PREV** followed by a **GO**.

/Sctl/\$globals/fdrsel	I	0..1		Screen Touch Fader Select
/Sctl/\$globals/fdrres	S		NORM, FINE, AUTO	Fader resolution
/Sctl/\$globals/fdrspd	S		SLOW, MED, FAST	Fader speed
/Sctl/\$globals/mousetchdis	I	0..1		Mouse disable touch
/Sctl/\$globals/mousespd	F	0.1..2.0	191 steps	Mouse speed
/Sctl/\$globals/tapflash	S		OFF, 8X, ON	Tap Tempo Flash
/Sctl/\$globals/srcdisp	I	0..1		Show source on scribble
/Sctl/\$globals/lockmtr	I	0..1		Show meter page when locked
/Sctl/\$globals/showscene	I	0..1		Always show active scene
/Sctl/\$globals/cf_load	I	0..1		Confirm Snapshot Load
/Sctl/\$globals/cf_upd	I	0..1		Confirm Snapshot Update
/Sctl/\$globals/usewheel	I	0..1		Use wheel to navigate in lists of items (snaps, files,...)
/Sctl/\$globals/timefmt	S		24H, 12H	Time format
/Sctl/\$globals/date fmt	S		YMD, DMY	Date format
/Sctl/\$globals/\$filesort	S		NAME, TYPE, 0->9, 9->0	File sort order
/Sctl/\$globals/\$noautosave	I	0..1		Auto save switch (0=autosave)
/Sctl/\$globals/\$savenow	I	0..1		Save console data now <sup>74</sup>

## Global Settings

Command	Type	Range	Text	Description
/Sglobals	N			Global Settings node
/Sglobals/clkrate	S		48000.0, 44100.0	Master clock rate
/Sglobals/clksrc	S		INT, A, B, C, AES, CARD, MOD	Master clock source
/Sglobals/startmute	I	0..1		Mute outputs on startup
/Sglobals/usbacfg	S		2/2, 8/8, 16/16, 32/32, 48/48	USB Input/Output configuration
/Sglobals/sccfg	S		AUTO, 0/32, 1/31, 2/30, 3/29, 4/28, 5/27, 6/26, 7/25, 8/24, 9/23, 10/22, 11/21, 12/20, 13/19, 14/18, 15/17, 16/16, 17/15, 18/14, 19/13, 20/12, 21/11, 22/10, 23/9, 24/8, 25/7, 26/6, 27/5, 28/4, 29/3, 30/2, 31/1, 32/0	SC Configuration
/Sglobals/harnt	N			HA remote node
/Sglobals/harnt/a	I	0..1		Enable HA remote on AES-A
/Sglobals/harnt/b	I	0..1		Enable HA remote on AES-B
/Sglobals/harnt/c	I	0..1		Enable HA remote on AES-C
/Sglobals/custsync	N			Custom Sync node
/Sglobals/custsync /a	I	0..1		Enable Cust Sync on AES-A
/Sglobals/custsync /b	I	0..1		Enable Cust Sync on AES-B
/Sglobals/custsync /c	I	0..1		Enable Cust Sync on AES-C

<sup>74</sup> This command should not be used as part of a program loop as it will eventually wear the flash memory where data is saved. This command may change in the future.



## WING native / binary data interface

## WING native / binary data interface

WING exposes a binary structure that contains all data presented above in the **WING snapshot JSON structure** chapter, and more objects. Some objects are **READ ONLY** while others can be accessible for `get()` and `set()` functions. One can access the object data, effectively getting access to the value assigned to the object, or to the object description, a special class that provides the object name, type, min/max values, or enumerated values.

As mentioned before, communication takes place using TCP. We give all the basic/necessary details for communicating with WING below; this data is coming from Behringer.

Applications can communicate with the console using TCP port 2222. The console will reject further connection requests, if the maximum number of simultaneous connections (currently 16) is reached. Open connections will time out after 10 seconds of inactivity (on the receiving side).

## Communication Channels

Communication uses 14 distinct *channels* [1..14] corresponding to the Channel IDs presented below

<i>channel</i>	ChID	Usage
1	0	n/u
2	1	Audio Engine & Control requests
3	2	n/u
4	3	Meter Data Requests
5	4	n/u
6	5	n/u
7	6	n/u
8	7	n/u
9	8	n/u
10	9	n/u
11	A	n/u
12	B	n/u
13	C	n/u
14	D	n/u

To select/change the active channel, use the following sequence  
`0xdf, 0xd<ChID>`

When communicating with WING, the escape byte `0xdf` should be handled carefully, as shown in the two routines shown below for sending and receiving data.

## Sample receive routine

```
#define NRP_ESCAPE_CODE      0xdf
#define NRP_CHANNEL_ID_BASE  0xd0
#define NRP_NUM_CHANNELS     14

void Cnrpclientconnector::nrpc_data_rx(byte db)
{
    if (db == NRP_ESCAPE_CODE && !escf) escf = true;
    else {
        if (escf) {
            if (db != NRP_ESCAPE_CODE) {
                escf = false;
                if (db == NRP_ESCAPE_CODE - 1) db = NRP_ESCAPE_CODE;
                else if (db >= NRP_CHANNEL_ID_BASE &&
                        db < NRP_CHANNEL_ID_BASE + NRP_NUM_CHANNELS) {
                    if (ch_id_rx != db - NRP_CHANNEL_ID_BASE) {
                        ch_id_rx = db - NRP_CHANNEL_ID_BASE;
                    }
                    return;
                } else if (ch_id_rx >= 0) data_rx(ch_id_rx, NRP_ESCAPE_CODE);
            }
        }
        if (ch_id_rx >= 0) data_rx(ch_id_rx, db);
    }
}
```

Example: The sequence D702DFDEAF0E02 will in fact represent D702DFAF0E02

## Sample transmit routine

```
void Cnrpclientconnector::data_tx(int ch_id, const void* data, int len)
{
    assert(ch_id >= 1 && ch_id <= NRP_NUM_CHANNELS);

    if (ch_id_tx != ch_id) {
        ch_id_tx = ch_id;
        nrpc_data_tx_flush();
        nrpc_data_tx(NRP_ESCAPE_CODE);
        nrpc_data_tx(ch_id + NRP_CHANNEL_ID_BASE);
    }

    bool esc = false;
    byte* dpp = (byte*)data;
    while (len-- > 0) {
        byte db = *dpp++;
        if (db == NRP_ESCAPE_CODE) esc = true;
        else {
            if (esc && db >= NRP_CHANNEL_ID_BASE &&
                db <= NRP_CHANNEL_ID_BASE + NRP_NUM_CHANNELS) {
                db = NRP_ESCAPE_CODE - 1;
                dpp--;
                len++;
            }
            esc = false;
        }
        nrpc_data_tx(db);
    }
    if (esc) nrpc_data_tx(NRP_ESCAPE_CODE - 1);
}
```

Examples: With current tx channel being 3, sending d702dfaf0e02 to channel 1 will transfer dfd0d702dfaf0e02, sending d702dfd0e02 to channel 2 will transfer dfd1d702dfd0e02, and sending d702dfd10e02 to channel 1 again will transfer dfd0d702dfded10e02

## Channel 2: Audio Engine

Communication with the audio engine uses a token/data based binary stream protocol. Words are 2 bytes (big endian), longs are 4 bytes (big endian).

### Binary Stream Format

Token	Data	Function
0x00		false; off; 0
0x01		true; on; 1
0x02..0x3f		int 2..63
0x40..0x7f		node index 1..64
0x80..0xbf		string[1..64]
0xc0..0xcf		node name[1..16]
0xd0		empty string
0xd1	byte	string[1..256]
0xd2	word	node index 1..65536
0xd3	word	int16
0xd4	long	int32
0xd5	long	float32
0xd6	long	raw float32 (0.0..1.0)
0xd7	long	node hash
0xd8		click (toggle)
0xd9	byte	step (inc/dec)
0xda		node tree: goto root node
0xdb		node tree: 1 level up
0xdc		data request
0xdd		request node definition (current node)
0xde		end of data/def request
0xdf	word	node definition response (word: data length in bytes)
0xe0..0xff		not used

Navigation within the nodes tree can be done by using root, 1 level up, node index, \_node name, or node hash tokens.

Definitions of all subnodes within the current node can be requested with the request node definition token.

#### Node Definition Response

```
0xdf, len.w, [len.l], parent.l, hash.l, index.w, namelen.b, name, longnamelen.b, longname, flags.w,
  (If len.w==0 then len.l is used)
node: -
linf: min.f, max.f, steps.l
logf: min.f, max.f, steps.l
fdr: -
int: min.l, max.l
enum: count.w, [itemlen.b, item, longitemlen.b, longitem] * count
fenum: count.w, [itemval.f, longitemlen.b, longitem] * count
string: maxlen.w
```

Where the node type can be derived from the flags as follows:

Flags	Function	Details
b0..b3	unit	0: none 1: dB 2: % 3: ms 4: Hz 5: mtrs 6: seconds 7: octaves
b4..b7	type	0: node 1: lin float 2: log float

		3: fader level 4: integer 5: string enum 6: float enum 7: string
b9	r/o	read-only flag

## Channel 3: Metering

Use this channel to request metering data from the console. The data is sent back to the client IP to the specified port. Meter data times out after 5 seconds.

Each metering data block is prefixed by a client-specified 4byte report id.

In order to avoid confusion on the receiver side, the client should use different report ids for different meter collections. Meter collections are specified by using multiple type/index elements.

Specified meters are sent back in the sequence corresponding to the request message.

Details:

Meter values are coded on 2 bytes (signed, big endian). Level values are in 1/256 dB.

Most data are returned in 1/256 steps. This is typically the case for Gate gain and Dyn gain values. The returned value is multiplied/adjusted with a fixed value to cover for the plugin model data range in use. For most of them 1.0 (256) maps to 20 dB gain reduction. Standard Wing gate is 60 dB.

fx meter subscriptions return 4 levels and 6 state meters (see table below: Meter Data). Band gain reduction is in the first 5 of these. Value in dB = return value \* 6.0 / 2048.

Gate LED and Dyn State in \* V2 subscriptions return a value of 0 or 1, depending on the state of the respective channel's Gate and Dyn LEDs, respectively.

## Meter Request Tokens

Table 4. Meter Request Tokens		
Token	Data	Function
0xd3	word	client UDP port (2 bytes big endian; set at least once)
0xd4	long	report id (repeat this token with current id to reset transmission timeout)
0xdc		start of meter collection definition
	0xa0	channel (1...40)
	0xa1	aux (1...8)
	0xa2	bus (1...16)
	0xa3	main (1...4)
	0xa4	matrix (1...8)
	0xa5	dca (1...8)
	0xa6	fx processor (1...16)
	0xa7	source (input) device (1...16)
	0xa8	output device (1...11)
	0xa9	monitor (no index)
	0xaa	rta (no index)
	0xab	channel V2 (1...40)
	0xac	aux V2 (1...8)
	0xad	bus V2 (1...16)
	0xae	main V2 (1...4)
	0xaf	matrix V2 (1...8)
	0x00...0x7f	index 1...128 (can be repeated multiple times)
0xde		end of meter collection definition

Example specification

```
0xdc 0xa0 0x00 0x01 0x08 0xa6 0x04 0xde
```

Requests meter data for channels strips 1,2,9, and fx 5.

Meter Data Packet Structure := <report id (4 bytes)><Meter Data (n words)>

## Meter Data

Table 5. Meter Data	
Section	Contents
channel aux bus main matrix	input left input right output left output right gate key gate gain dyn key dyn gain
dca	pre fader left pre fader right post fader left post fader right
fx	input left input right output left output right state meters (1..6)
source	source group levels (i.e. local ins: 8 meters)
output	output group levels (i.e. local outs: 8 meters)
monitor	solo bus left solo bus right mon 1 left mon 1 right mon 2 left mon 2 right
rta	rta slot meters (120)
Channel V2 aux V2 bus V2 main V2 matrix V2	input left input right output left output right gate key gate gain gate led dyn key dyn gain dyn state automix gain

We show below a typical binary communication sequence for requesting metering data:

```

→W 7 B: dfd3d33737dfd1 // Declaring port to use is 0x3737 = 14135
→W 13 B: dfd3d40000002dca001dedfd1 // Meters request id = 2, channel 02
→W 9 B: dfd3d40000002dfd1 // Renew request id = 2 meter data for 5s

```

## Introducing wapi (wapi)

The previous chapters on JSON structures and binary, token-based communication may not be very accessible to many programmers. For that reason, a more accessible API (Application Programming Interface) available as a set of include files and libraries is proposed here. It is written in C, which ensure it can easily be used in many applications, providing good performance.

There are two include files that should always be part of your programs as they contain information about the JSON structure and the objects respective binary pointers in WING. The API provides an abstraction layer to the binary interface and procedure calls for standard functions to get, set, manipulate WING data.

At the API level, WING data can be 32bit int, 32bit float or string data. All API data in little-endian, enabling easy use in standard programming languages.

Besides this document, the **wapi** API consists of two include files and a library:

**wapi.h** is the main include file containing enumerated types for errors, token types, and wapi abstraction enumerated tokens.

**wext.h** is a file containing the definitions of external library calls to wapi.lib the actual library of API functions.

**wapi.lib** is a static-link library for linking with your application. The library contains all wapi functions that can be used and are described later in this document.

A typical program accessing WING starts with an *'open'* function and ends with a *'close'* function. These two functions establish the communication path to WING on your local network and ensure data is properly cleaned when leaving the program.

Programs communicate with WING over network. The API call `wOpen()` is used to establish communication link between WING and the application.

WING supports multiple formats, including integers, floats, and strings types. The API will try to ensure conversions as best as possible in order to match the requested format either by WING or by the API command. For example, if you request float data from a WING token which is an integer, the API will convert the integer to float before returning the data. Similarly, if you set a WING token of type string by sending it a float value, the float data will be changed to string before being sent to WING.

## wapi tokens

**wapi** makes use of **tokens** (an enumerated 32bits integer acting as a unique identifier) to identify the subtrees and leaves of the WING JSON hierarchy structure. WING tokens are easily identified by their name, based on their corresponding JSON structure name taken from the WING hierarchical data tree we already presented in this document.

For example the identifier for "channel 1 mute control", a.k.a "ch.1.mute" in the JSON tree is known as token `CH_1_MUTE`. The respective parameter in WING internal data structure is an integer that can be 0 or 1 and as written above, can be modified (or set) from integer, float or even string data types, and can be returned to the application also as an integer, a float or string.

Following the naming convention above "channel 1 fader value" will be identified as "CH\_1\_FDR", "bus 14 panoramic value" will be identify as "BUS\_14\_PAN", and so on.



Some identifiers can have names that are not as obvious, and this typical of some of the dynamically assignable subtrees of the JSON tree. Typically, the filter, gate, compressor, and equalizer of WING channels can be assigned different plugin models, set for example using the `wapi CH_1_EQ_MDL` token (or `OSC ch/1/eq/md1`), known as channel 1 EQ model in the case of channel 1 and its EQ setting. If you report to the different types (or models) of EQ plugins in the appendices of this document, you will see that the EQ model can be one of several choices, each model having different settings. In fact, every single setting maps to a given token, based on their respective listing number, e.i. `setting #7`, a.k.a. “1q” for EQ model “STD” will have the same token value as `setting #7` for EQ model SOUL, known as “1mg”.

To enable `wapi` managing these different mapping, all JSON “dynamic” parameters are named after their listing number, rather than their name for a given effect or plugin model. As a result, and taking the case of EQ models “STD” and “SOUL” above, setting “1q” and “1mg” will have the share the same token ending with “7” (for listing #7).

The naming convention above applies to the following:

- Channel: filter, gate, compressor, equalizer [“1”, “2”, ... “33”]
- Bus, Mains, Matrix: compressor, equalizer [“1”, “2”, ... “33”]
- FX: all fx meter settings [“1”, “2”, ... “33”]
- GPIOs [“1”, “2”]
- User buttons [“1”, “2”, “3”]
- Layered user encoders and buttons [“1”, “2”, “3”]

Some tokens correspond to read-only data; trying to change their value will result in an error returned to the calling function.

WING tokens are listed in an include file: `wapi.h` that must be included in your program. The `wapi.h` include file also contains the status or error codes that can be returned by API function calls.

## Compiling a program using `wapi`

All function calls are regrouped in a binary library: `wapi.lib`, that you must include at link time.

A typical compilation of a source file `wtest.c` in a Windows environment can be as follows:

```
gcc -O3 -Wall -c -fmessage-length=0 -o wtest.o "wtest.c"  
gcc "-LC:<path to wapi.lib>" -o wtest.exe wtest.o -lwapi -lws2_32
```

Don't forget to set the correct path to the `wapi.lib` file in the above compilation/link lines!

Depending on your application, you may need to provide additional Windows dynamic libraries references (i.e. `-lgdi32`, `-lcomdlg32`, etc.)

WING parameters can be set (or modified) using the `wSetxxx` API family of calls; Similarly, the parameters can be retrieved from WING using the `wGetxxx` API family of calls. The following pages will present all API functions and will include examples of source code to help you in your first steps with `wapi`.

Additional calls will serve establishing the communication path with the console, and several services and utility functions needed to parse, or help with data.

## wapi Reference Guide

# wapi Reference Guide

## Open and Close

### *int wOpen(char\* wip)*

`wOpen()` initializes global variables for the application and opens the communication with a WING console responding at IP address `wip`.

`wip` is a string containing the console IP data in the form “xxx.xxx.xxx.xxx”; if the console IP address is unknown, `wip` should be an empty string and provide enough characters to store the IP address where WING will be found. The `wOpen()` function will attempt a network broadcast announce on the /24<sup>75</sup> of the local network to identify the first WING that will reply on the local network.

Upon successful completion the function will return `WSUCCESS` and if the `wip` parameter was an empty string when calling the function, it will contain the IP at which the console was found. Other values can be returned in case of issues or errors reported.

Once connection is established with the console, it will be kept active for about 10 seconds after which the console will close the link. The `wKeepAlive()` function can be called (before the desk closes communication) to extend the link active another 10 seconds.

It must be noted that if a connection is kept active, changes made directly at the console (by moving a fader, or pressing buttons for example) will generate data the application will continuously receive. This can represent a lot of data the application must be ready to accept and manage. It can also be the source of incorrect data returned to `Get` functions and specific care should be taken when developing live or event-driven applications.

### *void wClose()*

`wClose()` ensures data is correctly disposed of when your program ends. It should be the last call before the `return` statement or `exit` call in your application.

### *int wVer()*

`wVer()` returns the version of the wapi library file being used. The returned version is in the form ‘major.minor.revision’, and its value is provided as `0x0000MmmV`, with `M.mm` being the standard major.minor version number corresponding as close as possible to the Wing FW release wapi was based on, and `v` represents a software build revision number within `M.mm`.

---

<sup>75</sup> For example, 198.51.100.0/24 is the prefix of the Internet Protocol version 4 network starting at the given address, having 24 bits allocated for the network prefix, and the remaining 8 bits reserved for host addressing. Addresses in the range 198.51.100.0 to 198.51.100.255 belong to this network.

## Setting Values

### *int wSetTokenFloat(wtoken token, float fva1)*

The `wSetTokenFloat()` sets WING token `token` to float value `fva1`. If the token `token` is of a different type than float, `fva1` will be adapted to the format expected by token `token`; if token `token` corresponds to a dynamic parameter named 1 to 32, no format change will take place and the function will set token `token` using `fva1` as float.

For example, sending value `444.0` to WING token `CH_1_PEQ_1F` will be sent as a 32bit float value. WING will nevertheless adjust it to the nearest valid value of `444.533997`. Sending that same value `444.0` to WING token `CH_1_PEQ_ON` will result in a setting to 1; Finally, sending value `444.0` to WING token `CH_1_NAME` will change the channel name to `444.00`.

To change the value of `CH_1_EQ_1` to say 'ten' should be sent as float `10.0`, assuming the parameter's value expected type is float.

The function returns `WSUCCESS` if the requested operation was successful, other values can be returned, such as `WZERO` if no suitable format was found for adapting the value of `fva1`, or `WSEND_TCP_ERROR` if an error took place while communicating with WING. Attempting to set a value on a token of type `NODE` will return `WNODE`.

### *int wSetTokenInt(wtoken token, int iva1)*

The `wSetTokenInt()` sets WING token `token` to int value `iva1`. If the token `token` is of a different type than int, `iva1` will be adapted to the format expected by token `token`; if token `token` corresponds to a dynamic parameter named 1 to 32, no format change will take place and the function will set token `token` using `iva1` as int.

For example, sending value `444` to WING token `CH_1_PEQ_ON` will result in a setting to 1; Finally, sending integer value `444` to WING token `CH_1_NAME` will change the channel name to `444`.

In order to change the value of `CH_1_GATE_5` to say 'one' with `CH_1_GATE_MDL` set to "`9000G`" should be sent as int 1, as the parameter's value expected type is int.

The function returns `WSUCCESS` if the requested operation was successful, other values can be returned, such as `WZERO` if no suitable format was found for adapting the value of `iva1`, or `WSEND_TCP_ERROR` if an error took place while communicating with WING. Attempting to set a value on a token of type `NODE` will return `WNODE`.

### *int wSetTokenString(wtoken token, char\* str)*

The `wSetTokenString()` function takes as input a WING token `token` and a string `str`. It sends to WING the value of `str` after it has been adapted to the format expected by the WING token it is sent to.

For example, sending string "`444`" to WING token `CH_1_PEQ_1F` will be sent as a 32bit float value of `444.0`; WING will adjust it to the nearest valid value of `444.533997`. Sending that same string "`444`" to WING token `CH_1_PEQ_ON` will result in a setting to 1, Finally, sending string "`444`" to WING token `CH_1_NAME` will change the channel name to `444`.

To change the value of `CH_1_GATE_6` to say 'gate' with `CH_1_GATE_MDL` set to "`9000G`" should be sent as "`GATE`", as the parameter's value expected type is string.

The function returns `WSUCCESS` if the requested operation was successful, other values can be returned, such as `WZERO` if no suitable format was found for adapting the string `str`, or `WSEND_TCP_ERROR` if an error took place while communicating with WING. Attempting to set a value on a token of type `NODE` will return `WNODE`.

## Getting Values

`wapi` offers several procedure calls to retrieve data from WING; specific datasets can be of use when getting data. These are defined in `wapi.h`:

`wvalue` is a union type definition to enable receiving several types of data in a single 32bits field.

```
typedef union {
    unsigned int    uval;    // unisgned integer type data
    int             ival;    // integert type data
    float           fval;    // float type data
    char*           sval;    // pointer to string
} wvalue;
```

`wtype` is an enumerated list of ints to provide the data type returned in `wvalue`.

```
typedef enum wtype {
    UNKN = -1,
    NODE,    // node type (unsigned int)
    I32,     // int type
    F32,     // float type
    S32,     // string (char*) type
    V32     // an unsigned int or void type to accept all the above
} wtype;
```

`wTV` is a C structure defined in the `wapi.h` file as follows:

```
typedef struct {
    wtoken    token;
    wtype     type;
    union {
        unsigned int udata;
        int          idata;
        float        fdata;
        char*        sdata;
    } d;
} wTV;
```

The filling of the structure is obvious for `int` and `float` data; `string` data sets are dynamically allocated and the pointer of the allocated string is saved in `sdata`; if the string returned from the console is an empty string, no memory allocation takes place and a `NULL` pointer is set in `sdata`.

### *wtype wGetType(wtoken token)*

`wGetType()` returns the type associated to the token `token`; the returned value is one of the types listed in the `wtype` list described above.

### *char\* wGetName(wtoken token)*

`wGetName()` returns the string JSON descriptor corresponding to token `token`. The returned string is part of the constant definitions of `wapi` and cannot be altered by the calling application.

Note that the string “`$$unkown`” (not part of the JSON tree leaves) is returned for tokens that are not found.

### *wHash wGetHash(wtoken token)*

wGetHash() returns the binary descriptor (an unsigned int) corresponding to token token. The returned data can be used to identify specific entries in binary maps returned by wapi with the wGetBinaryNode() call (see later in this document). The value 0 is returned for tokens that are not found.

### *int wGetToken(wtoken token, wtype \*type, wvalue \*value)*

The wGetToken() function retrieves data from WING, based on token token.

wGetToken() is a generic data retrieval call for wapi; Other retrieval functions described later in this document may be more tuned to your specific needs.

Depending on user actions, several data can queue in the receiving buffer; The function will use the data provided by the first occurrence of token token in the queue.

The data type returned by WING is used to set a more generic type in type, which can be one of int, float or string address on 32 bits data.

The actual value corresponding to int and float data is returned in value; In the case of string data (char\*), either a NULL pointer is returned for no character present, or value contains the pointer to a string of characters.

Note that in the case a string is returned by wGetToken(), memory for storing the string will have been allocated by the function. It is the responsibility of the calling application to free the allocated memory when no longer needed to avoid application memory leaks.

wGetToken() will return WSUCCESS if the token token is found in the receiving queue and valid data is returned, WZERO if no valid data type is found or if a timeout occurs during receiving data.

WMEMORY, WSENDERROR or WRECVERROR can be returned in specific error cases.

Below is a small program example of using set() and get() calls, the receiving part using the wGetToken() function we first show the display obtained from running the program, followed by the program source code;

```
PS C:\Users\patri\eclipse\wtest\release> ./wtest
WING found at IP: 192.168.1.71
Using version 0.10
type = 3, data = RIDE
type = 2, data = -50.000000
type = 2, data = 0.000000
type = 1, data = 20
type = 2, data = 8.000000
type = 2, data = 0.486968
type = 2, data = 6.000000
```

```
#include <stdio.h>
#include <string.h>
//
#include "wapi.h"
#include "wext.h"
//
int main() {
    int            i;
    char           wingip[24] = "";
    wtype          type;
    wvalue         value;
    //
    if ((i = wOpen(wingip)) != WSUCCESS) exit(1);
    printf("WING found at IP: %s\n", wingip);
    printf("Using version %i.%i\n", wVer()/256, wVer()&15);
    //
    wSetTokenString(CH_1_GATE_MDL, "RIDE");           //Auto Rider Dynamics
    wSetTokenFloat(CH_1_GATE_1, -50.);                // thr
```

```

wSetTokenFloat(CH_1_GATE_2, 0.);           // tgt
wSetTokenInt(CH_1_GATE_3, 20);            // spd
wSetTokenFloat(CH_1_GATE_4, 8.);          // ratio
wSetTokenFloat(CH_1_GATE_5, 0.5);         // hold
wSetTokenFloat(CH_1_GATE_6, 6.0);         // range
//
wGetToken(CH_1_GATE_MDL, &type, &value);
if (value.sval) {
    printf("type = %i, data = %s\n", type, value.sval);
    free(value.sval);
} else {
    printf("no data for ch 1 gate model!\n");
}
wGetToken(CH_1_GATE_1, &type, &value);
printf("type = %i, data = %f\n", type, value.fval);
wGetToken(CH_1_GATE_2, &type, &value);
printf("type = %i, data = %f\n", type, value.fval);
wGetToken(CH_1_GATE_3, &type, &value);
printf("type = %i, data = %i\n", type, value.ival);
wGetToken(CH_1_GATE_4, &type, &value);
printf("type = %i, data = %f\n", type, value.fval);
wGetToken(CH_1_GATE_5, &type, &value);
printf("type = %i, data = %f\n", type, value.fval);
wGetToken(CH_1_GATE_6, &type, &value);
printf("type = %i, data = %f\n\n", type, value.fval);
fflush(stdout);
return(0);
}

```

### *int wGetTokenFloat(wtoken token, float\* fval)*

The `wGetTokenFloat()` function interrogates WING token `token` to get its currently associated value.

As it is the case for `wGetToken()`, `wGetTokenFloat()` will block until a token `token` is encountered in the receiving queue. The received token value has a given native type, and the function will do its best at converting the received data to float format as expected by the `fval` variable.

For example, inquiring WING token `CH_1_PEQ_1F` will return the current value of the token as a float value in `fval`. Inquiring WING token `CH_1_PEQ_ON` will result in a value of `0.0` or `1.0`, depending on the state of the token.

On the other hand, inquiring WING token `CH_1_NAME` will most likely return a value of `0.0` and a status of `WZERO`; In some cases (i.e., you set the name to be string “123.7” for example) you may get a valid floating-point value returned.

The function returns `WSUCCESS` if the requested operation was successful, other values can be returned, such as `WZERO` if no suitable format was found for adapting token value to `fval`, or `WSEND_TCP_ERROR` if an error took place while communicating with WING. Attempting to get a value from a token of type `NODE` will return `WNODE`.

### *int wGetTokenInt(wtoken token, int\* ival)*

The `wGetTokenInt()` function interrogates WING token `token` to get its currently associated value. As it is the case for `wGetToken()`, `wGetTokenInt()` will block until a token `token` is encountered in the receiving queue.

The received token value has a given native type, and the function will do its best at converting the received data to integer format as expected by the `ival` variable.

For example, inquiring WING token `CH_1_PEQ_1F` will return the current value of the token as an int value in `ival`. Inquiring WING token `CH_1_PEQ_ON` will result in a value of `0` or `1`, depending on the state of the token.

On the other hand, inquiring WING token `CH_1_NAME` will return a value of `0` and a status of `WZERO`; In some cases (i.e., you set the name to be string “12” for example) you may get a valid int value returned.

The function returns `WSUCCESS` if the requested operation was successful, other values can be returned, such as `WZERO` if no suitable format was found for adapting token value to `ival`, or `WSEND_TCP_ERROR` if an error took place while communicating with WING. Attempting to get a value from a token of type `NODE` will return `WNODE`.

### *int wGetTokenString(wtoken token, char\* str)*

The `wGetTokenString()` function interrogates WING token `token` to get its currently associated value. As it is the case for `wGetToken()`, `wGetTokenString()` will block until a token `token` is encountered in the receiving queue. The received token value has a given native type, and the function will do its best at converting the received data to `string/char*` format as expected by the `str` variable.

For example, inquiring WING token `CH_1_PEQ_1F` will return the current value of the token as a string in `str`. Inquiring WING token `CH_1_PEQ_ON` will result in a 1-character string of “0” or “1”, depending on the state of the token. Similarly, a token with a floating-point native format would result in a string containing the string representation of the floating-point value.

As a last example, inquiring WING token `CH_1_NAME` will return the string currently used for naming channel 1. Please note that the `str` variable should provide enough space to collect the data returned by `wGetTokenString()`.

The function returns `WSUCCESS` if the requested operation was successful, other values can be returned, such as `WZERO` if no suitable format was found for adapting token value to `str`, or `WSEND_TCP_ERROR` if an error took place while communicating with WING. Attempting to get a value from a token of type `NODE` will return `WNODE`.

### *int wGetTokenDef(wtoken token, int \*num, unsigned char\* str)*

The `wGetTokenDef()` function interrogates WING token `token` to get its currently associated definition in raw form. As it is the case for `wGetToken()`, `wGetTokenDef()` will block until a token `token` is encountered in the receiving queue. The received token definition follows the description presented earlier in this document<sup>76</sup>. The returned data consists of the number of bytes `num` contained in an array of bytes `str`. Note that `str` is allocated by the `wGetTokenDef()` function; it is therefore the responsibility of the calling application to free the allocated memory when no longer needed. Parsing this data is left to the application, and follows the description for node definition response.

The `Get()` functions presented above are all “one shot read” functions so to speak; They request data from WING, and wait for the right token to appear in the receiving queue. They will return the buffer content, adapting it to the requested type of data when applicable. This is a simple way to gather information from the console, but comes with a caveat if someone is also manipulating (locally or remotely) the desk. Indeed, as other changes take place and assuming your communication channel is in an ‘open’ state (i.e., your last communication with WING is less than 10s old), the console will natively send you changes that are taking place, resulting of the local or remote changes operated onto the desk.

So, when a “one shot read” request arrives and is served, it will sort through the received data for the expected token, and in doing this will discard the data received prior to finding the correct token.

**wapi** therefore provides another set of `Get()` functions for applications requiring a finer time control over the data they exchange with WING. In this new set of functions, the `Get()` instance will, as for the non-timed versions, gather information from WING and filter the possibly multiple<sup>77</sup> received tokens for the first one matching the specified token provided at call time, for a given amount of time only. Only when the specified token is received or time has expired (whichever comes first) will the function process the data it received, if available.

---

<sup>76</sup> See “Node Definition Response” in the “WING native / binary data interface” chapter

<sup>77</sup> Can literally be hundreds



*int wGetTokenTimed(wtoken token, wtype \*type, wvalue \*value, int timeout)*

`wGetTokenTimed()` is equivalent to its blocking sibling function call `wGetToken()`, but will block only for up to `timeout` microseconds; If no data corresponding to token `token` is received during that amount of time, the function will return `WZERO`. If a token `token` is received within the time allocated by `timeout`, the function will parse data and return it as in the case of `wGetToken()`.

*int wGetTokenFloatTimed(wtoken token, float \*fval, int timeout)*

The `wGetFloatTimed()` function is similar to the `wGetTokenFloat()` function in the sense it aims at retrieving from WING data and adapt it to floating-point format before returning it to `fval`;

But it will do so over a period `timeout`, expressed in  $\mu$ s (microseconds).

As long as `timeout` is not reached, the function is inquiring WING for data; If after `timeout` has expired, no data appears available, a value of `WZERO` is returned.

If on the contrary data is available from WING, the function will check if the data token is the correct one; it will treat the data as done in the `wGetTokenFloat()` function; i.e. the value retrieved from WING is converted to float format as expected by the `fval` variable.

For example, inquiring WING token `CH_1_PEQ_1F` will return the current value of the token as a float value in `fval`. Inquiring WING token `CH_1_PEQ_ON` will result in a value of `0.0` or `1.0`, depending on the state of the token.

On the other hand, inquiring WING token `CH_1_NAME` will most likely return a value of `0.0` and a status of `WZERO`; In some cases (i.e., you set the name to be string “123.7” for example) you may get a valid floating-point value returned.

The function returns `WSUCCESS` if the requested operation was successful, other values can be returned, such as `WZERO` if no suitable format was found for adapting token value to `fval`, or `WSEND_TCP_ERROR` if an error took place while communicating with WING. Attempting to get a value from a token of type `NODE` will return `WNODE`. If data is available from WING and the data token is not the expected one, the function discards data and inquires WING for new data. The above takes place as long as `timeout` is not reached.

*int wGetTokenIntTimed(wtoken token, int \*ival, int timeout)*

The `wGetTokenIntTimed()` function is similar to the `wGetTokenInt()` function in the sense it aims at retrieving from WING data and adapt it to floating-point format before returning it to `ival`;

But it will do so over a period `timeout`, expressed in  $\mu$ s (microseconds).

As long as `timeout` is not reached, the function is inquiring WING for data, if no data appears available, a value of `WZERO` is returned.

If on the contrary data is available from WING, the function will check if the data token is the correct one; it will treat the data as done in the `wGetTokenInt()` function; i.e. the value retrieved from WING is adapted to float format as expected by the `ival` variable.

For example, inquiring WING token `CH_1_PEQ_1F` will return the current value of the token as an int value in `ival`. Inquiring WING token `CH_1_PEQ_ON` will result in a value of `0` or `1`, depending on the state of the token.

On the other hand, inquiring WING token `CH_1_NAME` will return a value of `0` and a status of `WZERO`; In some cases (i.e., you set the name to be string “12” for example) you may get a valid int value returned.

The function returns `WSUCCESS` if the requested operation was successful, other values can be returned, such as `WZERO` if no suitable format was found for converting the retrieved value to `ival`, or `WSEND_TCP_ERROR` if an

error took place while communicating with WING. Attempting to get a value from a token of type `NODE` will return `WNODE`.

If data is available from WING and the data token is not the expected one, the function discards data and inquires WING for new data. The above takes place as long as timeout is not reached.

*int wGetTokenStringTimed(wtoken token, char\* str, int timeout)*

The `wGetTokenStringTimed()` function is similar to the `wGetTokenString()` function in the sense it aims at retrieving from WING data and adapt it to string format before returning it to `str`;

But it will do so over a period `timeout`, expressed in  $\mu$ s (microseconds).

As long as timeout is not reached, the function is inquiring WING for data, if no data appears available, a value of `WZERO` is returned.

If on the contrary data is available from WING, the function will check if the data token is the correct one; `wGetTokenStringTimed()` will then treat the data as done in the `wGetTokenString()` function; The value retrieved from WING is adapted to string format as expected by the `str` variable. Similar restrictions and conversion rules apply. For example, inquiring WING token `CH_1_PEQ_1F` will return the current value of the token as a string in `str`. Inquiring WING token `CH_1_PEQ_ON` will result in a 1-character string of “0” or “1”, depending on the state of the token. Similarly, a token with a floating-point native format would result in a string containing the string representation of the floating-point value. As a last example, inquiring WING token `CH_1_NAME` will return the string currently used for naming channel 1. Attempting to get a value from a token of type `NODE` will return `WNODE`.

If data is available from WING and the data token is not the expected one, the function discards data and inquires WING for new data. The above takes place as long as timeout is not reached.

## A Small Program Example

Let's program! Assume you need to programmatically change the name of channels and mute/unmute the respective channels from data contained in a file. Let's consider the file also contains initial channel faders, and covers channels 1 to 4. The file can be a text file such as:

```
Steve 0 -144.0
Jimmy 1 -30.0
Carla 1 -22.0
Jannet 0 -100.0
```

This is C source code; easy to understand and translate if needed to other programming languages. We show on the right of the page the resulting channel strips 1-4:

```
#include <stdio.h>
#include <string.h>
//
#include "wapi.h"
#include "wext.h"
//
int main() {
    wtoken ntoken[] = {CH_1_NAME, CH_2_NAME, CH_3_NAME, CH_4_NAME};
    wtoken mtoken[] = {CH_1_MUTE, CH_2_MUTE, CH_3_MUTE, CH_4_MUTE};
    wtoken ftoken[] = {CH_1_FDR, CH_2_FDR, CH_3_FDR, CH_4_FDR};
    char wingip[24] = "";    int    mute;
    float fader;
    char name[24];
    FILE* fd;
    //
    // we don't know the IP of our console...
    if (wOpen(wingip) != WSUCCESS) exit(1);
    printf("WING found at IP: %s\n", wingip);
    // open the file for reading
    if ((fd = fopen("file", "r")) != 0) {
        for (int i = 0; i < 4; i++) {
            // get data from the file
            fscanf(fd, "%23s %i %f", name, &mute, &fader);
            printf("%s %i %f\n", name, mute, fader);
            // set/send values to WING;
            // we don't care about the returned status
            wSetTokenString(ntoken[i], name);
            wSetTokenInt(mtoken[i], mute);
            wSetTokenFloat(ftoken[i], fader);
        }
    }
    fclose(fd);
    wClose();
    exit(0);
}
```



## Event-driven updates

There are times and situations when WING will send data to your program. This has been explained above: As soon as you are connected to WING and have exchanged data with it, the connection will stay in an open state for 10s, unless you specifically establish and close the TCP connection around your work. While this will help, it will not prevent WING to send you data while the TCP link is active, and is certainly not an effective way to manage data as you will send more resources in opening/closing the connection than in time sending or receiving data.

**wapi** provides additional API functions to manage event driven applications. These are managed around the notion of 'main loop' as often found in IOT devices running Arduino devices, in standard Linux or Windows applications where a main loop ensures the management of all events coming from devices connected to your computer (mouse, keyboard, etc.). WING data can be treated just as any other event.

API calls are therefore available to keep a connection between your application and WING alive, as well as to get data from WING, effectively emptying the event queue of the communication with the console. This will be assured with the `wKeepAlive()` and the `wGetVoidPTokenTimed()` function calls presented below.

### *int wKeepAlive*

`wKeepAlive()` maintains the connection between WING and the calling program so data issued by the console with no request initiated by the program can be received in a main loop, or over an extended period of time beyond 10s<sup>78</sup>.

In fact, this function can be called as often as you like and will optionally performs a small exchange with the console, based on an internal timer. The elapsed time between two effective exchanges of data with the console depend on the value of `wKeepAlive_TIMEOUT` which is part of the `wapi.h` file.

The `wKeepAlive()` function returns `WSUCCESS` if a valid exchange took place to renew a 10 seconds working communication, or `WZERO` if no exchange was necessary. The function can also return the values of `WSEND_ERROR` or `WRECV_ERROR` if communication was not successful.

### *int wGetParsedEvents(wTV \*tv, int maxevents)*

The `wGetParsedEvents()` API call is a specific `Get` function. Unlike other `Get` functions previously presented in this document, it does not expect data from a specific token, nor a specified format in which the data from the console should be converted to. The function will check the WING receive event queue for data and will only return when data is received by removing the events available from the oldest queue record. If no valid data is found, the function eventually returns with a network error.

When data is available in the event queue events are retrieved in a FIFO order, and the token, type and data associated to events are returned to the calling application using the `tv` structure array. The function returns the number of events parsed if data has been returned to the calling program, `WZERO` if no events were found. It can also return `WMEMORY` on memory allocation errors or `WRECV_ERROR` on TCP read errors. The parameter `maxevents` represents the maximum number of entries `tv` can accept; The function will allocate memory for its event read buffer to match that size.

### *int wGetParsedEventsTimed(wTV \*tv, int maxevents, int timeout)*

The `wGetParsedEventsTimed()` API call is similar to the `wGetParsedEvents()` function, but will returned after a maximum time of `timeout` in  $\mu$ s. Like in the case of the `wGetParsedEvents()` function, `wGetParsedEventsTimed()`

---

<sup>78</sup> The actual value in the `wapi` library may vary (but less than 10s) to ensure stability in event driven communications

does not expect data from a specific token, nor a specified format in which the data from the console should be converted to. The function will check the WING receive event queue for data and will only return when data is received by removing the events available from the oldest queue record. If no data is found before a timeout of `timeout`  $\mu$ s, the function returns with a value `WZERO`.

If data is available in the event queue, events are retrieved in a FIFO order, and the token, type and data associated to events are returned to the calling application using the `tv` structure array. The function returns the number of events parsed if data has been returned to the calling program, `WZERO` if no events were found. It can also return `WMEMORY` on memory allocation errors or `WRECV_ERROR` on TCP read errors. The parameter `maxevents` represents the maximum number of entries `tv` can accept; The function will allocate memory for its event read buffer to match that size.

In a typical, simple example of use of the two API calls shown in the following paragraph, the main loop is replaced with a `while(1){}` statement.

```
#include <stdio.h>
#include <string.h>
//
#include "wapi.h"
#include "wext.h"
//
int main() {
    int    i, j;
    char   wingip[24] = "";
    wTV    TV[100];

    if ((i = wOpen(wingip)) != WSUCCESS) return(-1);
    printf("WING found at IP: %s\n", wingip);
    printf("Using version %i.%i\n", wVer()/256, wVer()&15);

    while (1) {
        wKeepAlive();
        //
        if ((i = wGetParsedEventsTimed(TV, 100, 1000)) > 0) {
            for (j = 0; j < i; j++) {
                printf("W-> %s type = %i, data = ", wGetName(TV[j].token), TV[j].type);
                if (TV[j].type == I32) printf("%i\n", TV[j].d.idata);
                if (TV[j].type == F32) printf("%.2f\n", TV[j].d.fdata);
                if (TV[j].type == S32) {
                    printf("%s\n", TV[j].d.sdata);
                    if (TV[j].d.sdata) free(TV[j].d.sdata);
                }
                fflush(stdout);
            }
        } else {
            if (i != WZERO) {
                printf("Error = %i\n", i); fflush(stdout);
            }
        }
    }
    return 0;
}
```

An example of (partial) output of the code snippet above, after launching the program and manipulating ch.1, 2 and 3 mutes and ch. 1 fader:

```
PS C:\Users\patri\eclipse\wtest\release> ./wtest
WING found at IP: 192.168.1.71
Using version 0.10
W-> ch.1.mute type = 1, data = 1
W-> ch.2.mute type = 1, data = 1
W-> ch.3.mute type = 1, data = 1
W-> ch.1.fdr type = 2, data = -144.00
W-> ch.1.fdr type = 2, data = -89.18
W-> ch.1.fdr type = 2, data = -87.07
W-> ch.1.fdr type = 2, data = -85.55
W-> ch.1.fdr type = 2, data = -84.49
```

# Nodes

In many applications as well as in browsing over the JSON data structure, one can easily envision it would be interesting for optimization purposes to get and set a group of attributes at once, rather than establishing communication requests for each single parameter.

Nodes were introduced in the X32 family to enable this functionality, and have been widely used in several applications for controlling the desk; In the case of WING this may be even more interesting due to the very large number/volume of parameter data available as one unrolls each branch in the JSON tree opening a new level of nodes and parameters. Each branch of the JSON tree can be walked through by a program, resulting in a (sometimes very large) set of {token, value} sets and a way to represent the depth in the hierarchical tree the reported sets are issues from.

We show below the node data extracted (using a wapi call) for a few nodes:

```
wing_root: {$stat{}, cfg{}, $syscfg{}, io{}, ch{}, aux{}, bus{}, main{}, mtx{}, dca{}, fx{},
cards{}, play{}, rec{}}
```

```
node $stat, size: 212,
.modtype=NONE,A.stat=-,dev="",.B.stat=-,dev="",.C.stat=-,dev="",.lock=1,ppm=0,solo=0,sip=0,rtcerr=
0,time=19:14:44,date=2020-12-08,usbstate=IDLE,usbvoiname=INTENS0,sc_stat=-,sc_devices="",sc_upcnt=
32,sc_dncnt=32,
```

```
node $syscfg, size: 187,
.consolename=HMS01,logflags="",ipmode=STATIC,ip0=192,ip1=168,ip2=1,ip3=71,msk0=255,msk1=255,msk2=2
55,msk3=0,gw0=192,gw1=168,gw2=1,gw3=254,$ipapply=0,$firmware=1.0922g8a2cd9b2:develop,
```

As mentioned above, some nodes such as ch, are very large (more than 80k characters).

The set of values in a node list can be variable depending on the options (effects for example) loaded in the console at the time of the call, but all tokens are fixed and only contain known data types; A node can be set and retrieved as a single line of text with pre-formatted data, making it easy to store and manage in applications. wapi offers two methods of saving node data sets from the console, the first one is returning data similar to what is obtained using OSC (text data); the other one is more suitable to direct use from a compiled program, with binary data saved in specific structures containing the token and its respective data. The first method typically takes 2 or 3 seconds to get all WING data as multiple strings of node data. The second method is probably more suitable for use with wapi and is also faster (1 to 2 seconds) as no formatting is involved in saving the data returned by the console.

The following functions list API entries to use WING nodes as defined above.

### *int wSetNode(char \*str)*

The `wSetNode()` function parses the string contained in `str` according to the format used in OSC nodes; For example, a string such as `/ch.1.fdr 8.5,mute 1,/bus.1.fdr 5.0,.2.fdr=0.5` will set fader of channel 1 to the 8.5dB value and mute the channel. Bus 1 fader will be set to 5dB and bus 2 fader will be set to 0.5dB. Each parameter group is separated by a `'` character, the `'/'` character represents the root of the JSON parameter tree, and `'.'` characters are used to navigate up and down within the JSON parameter tree. The function returns a status `WSUCCESS` if the string was processed with no errors; It will return `WNODE` if a token or value provided with the string `str` is not valid. The function can also report other errors if communication issues were detected. `str` must be `\0` ended. Please see an example of use below.

### *int wSetNodeFromTVArray(wTV \*array, int nTV)*

The `wSetNodeFromTVArray()` function sends updates to WING in a single network exchange from the `nTV` elements in `wTV` (see below) array `array`; This is a great way to improve network performance. Although the function is the symmetrical to `wGetNodeToTVArray()`, it can accept hierarchically organized elements or uncorrelated elements as long as they are not nodes and contain valid tokens-values sets. The function returns `WSUCCESS` or an error if one takes place during allocating, preparing, or sending the resulting network buffer to WING.

### *int wSetBinaryNode (unsigned char \*array, int len)*

The `wSetBinaryNode()` function will load from `array` the `len` bytes of binary data commands to be executed by the desk in a single call. The function returns the number of bytes sent to the console on success or an error if one takes place during sending the buffer to WING.

The length value returned by the call can be greater than the value of `len`. This results from the function call possibly adding escape characters specific to Wing native/binary protocol.

A typical use for this call is external scene management<sup>79</sup> such as in the code snippet below.

```
void WRestoreS() {
    unsigned char node[256000];
    int i, j;
    //
    if ((fd = fopen("Scene.scn", "rb")) != NULL) {
        fread(&i, sizeof(int), 1, fd);
        fread(node, i * sizeof(unsigned char), 1, fd);
        if ((j = wSetBinaryNode(node, i)) < i) {
            printf("Error: %d only bytes sent vs. %d\n", j, i);
        } else {
            printf("Restored Scene\n");
        }
        fclose(fd);
    } else {
        printf("Cannot open Scene.scn\n");
    }
    Return;
}
```

---

<sup>79</sup> As opposed to WING internal Show files and Scene entities (see dedicated chapter)

*int wGetNode(wtoken node, char \*str)*

The `wGetNode()` function will return in `str` a string of values separated formatted as in the OSC node convention and corresponding to the node token `node`.

`str` must be large enough to accept the characters returned by the call. The function returns a status `WSUCCESS` if the node was processed with no errors; It will return `WTKEN` if the token provided is not a valid node and `WNODE` if an error occurs during parsing the data received from the console. The function can also report other errors if communication issues were detected. The line of text returned by the function end with a line-feed and a `\0` byte.

*int wGetNodeToTVArray (wtoken node, wTV \*array)*

The `wGetNodeToTVArray()` function will return in `TV`, an array of structures `wTV` (see below), all values respective of their corresponding token and part of the node token `node`.

`array` must be large enough to accept the data returned by the call (see below for the number of elements for each level-1 node). The function the number of tokens in the array `array` if the node was processed with no errors; It will return `WTKEN` if the token provided is not a valid node and `WNODE` if an error occurs during parsing the data received from the console. The function can also report other errors if communication issues were detected.

Below is an indicative value of the number of `wTV` structures in the returned arrays for each level-1 node of the console at the time of this writing; The sum of the values following 'size:' give an idea of the number of parameters the console knows.

```
node $stat, size: 23
node cfg, size: 194
node $syscfg, size: 25
node io, size: 6054
node ch, size: 12400
node aux, size: 2008
node bus, size: 2736
node main, size: 440
node mtx, size: 728
node dca, size: 144
node mgrp, size: 16
node fx, size: 624
node cards, size: 74
node play, size: 18
node rec, size: 7
node $ctl, size: 5328
node $globals, size: 11
```

Below is a C code source example of use of `wSetNode()`; The program will set the faders of channels 1 to 4 to different positions, unmute channels 1 and 3, channel 2 mute is unchanged and channel 4 will be muted. DCA 1 is muted and its fader is set to 1dB.

```
/*
 * wtest.c
 *
 * Created on: Oct. 18, 2020
 * Author: Patrick-Gilles Maillot
 */
#define _WIN32_WINNT 0x501
//
#include <stdio.h>
#include <string.h>
```



```

//
#include "wapi.h"
#include "wext.h"
//
int main() {
    int    i;
    char   wingip[24] = "";

    char   wtest1[64] = "/ch.1.fdr 8.5,mute=0,.2.fdr=0,/dca.1.fdr=1.0,mute=0";
    char   wtest2[64] = "/ch.3.fdr -20,mute=0,.4.fdr=-60,mute=1";
    //
    if ((i = wOpen(wingip)) != WSUCCESS) exit(1);
    printf("WING found at IP: %s\n", wingip);
    printf("Using version %i.%i\n", wVer()/256, wVer()/255);
    //
    i = wSetNode(wtest1);
    printf("result = %d, initial data: %s\n", i, wtest1);
    i = wSetNode(wtest2);
    printf("result = %d, initial data: %s\n", i, wtest2);
    fflush(stdout);
    return(0);
}

```

A listing of the program when ran:

```

PS C:\Users\patri> cd eclipse/wtest/release
PS C:\Users\patri\eclipse/wtest/release> ./wtest
WING found at IP: 192.168.1.71
Using version 0.6
result = 1, initial data: /ch.1.fdr 8.5,mute=0,.2.fdr=0,/dca.1.fdr=1.0,mute=0
result = 1, initial data: /ch.3.fdr -20,mute=0,.4.fdr=-60,mute=1
PS C:\Users\patri\eclipse/wtest/release>

```

Below the resulting state of the console, starting from an init state:



Requesting the full set of nodes from a freshly initialized console<sup>80</sup> results in a file of 200000+ characters, and is therefore a lot of data to manage. Over WIFI, it takes about 2 seconds to execute a full dump as OSC-like node data and 1 to 2 seconds to retrieve a full dump as wTV structures.

We show below a typical example of the OSC-like node string for ch. 1 returned by **wapi** when using **wGetNode()**:

<sup>80</sup> FW 1.10

node ch:

```
.1.in.set.$mode=M,srcauto=0,altsrc=0,inv=0,trim=0.00,bal=0.00,$g=0.00,$vph=0,dly=0.00,.conn.grp=LC
L,in=1,altgrp=OFF,altin=1,..flt.lc=0,lcf=100.24,hc=0,hcf=10018.26,tf=0,mdl=TILT,tilt=0.00,.clink=0
,col=1,name="",icon=1,led=1,mute=0,fdr=144.00,pan=0.00,wid=100.00,$solo=0,$sololed=0,solosafe=0,mo
n=A,proc=GEDI,ptap=4,$presolo=0,peq.on=0,lg=0.00,lf=99.69,lq=2.00,2g=0.00,2f=999.25,2q=2.00,3g=0.0
0,3f=10016.53,3q=2.00,.gate.on=0,mdl=GATE,thr=40.00,range=40.00,att=10.00,hld=10.00,rel=199.40,acc
=0.00,ratio=1:3,.gatesc.type=OFF,f=1002.37,q=2.00,src=SELF,tap=IN,$solo=0,.eq.on=0,mdl=STD,mix=100
.00,$solo=0,$solobd=1,lg=0.00,lf=80.20,lq=2.00,leq=SHV,lg=0.00,lf=200.00,1q=2.00,2g=0.00,2f=601.39
,2q=2.00,3g=0.00,3f=1499.79,3q=2.00,4g=0.
00,4f=3990.52,4q=2.00,hg=0.00,hf=11994.42,hq=2.00,heq=SHV,.dyn.on=0,mdl=COMP,mix=100.00,gain=0.00,
thr=10.00,ratio=3.00,knee=3,det=RMS,att=50.00,hld=20.00,rel=152.57,env=LOG,auto=1,.dynxo.depth=6.0
0,type=OFF,f=1002.37,$solo=0,.dynsc.type=OFF,f=1002.37,q=2.00,src=SELF,tap=IN,$solo=0,.preins.on=0
,ins=NONE,$stat=,.main.1.on=1,lvl=0.00,.2.on=0,lvl=0.00,.3.on=0,lvl=0.00,.4.on=0,lvl=0.00,..send.1
.on=0,lvl=144.00,pon=0,ind=0,mode=PRE,plink=0,pan=0.00,wid=100.00,.2.on=0,lvl=144.00,pon=0,ind=0,m
ode=PRE,plink=0,pan=0.00,wid=100.00,.3.on=0,lvl=144.00,pon=0,ind=0,mode=PRE,plink=0,pan=0.00,wid=1
00.00,.4.on=0,lvl=144.00,pon=0,ind=0,mode=PRE,plink=0,pan=0.00,wid=100.00,.5.on=0,lvl=144.00,pon=0
,ind=0,mode=PRE,plink=0,pan=0.00,wid=100.00,.6.on=0,lvl=144.00,pon=0,ind=0,mode=PRE,plink=0,pan=0.
00,wid=100.00,.7.on=0,lvl=144.00,pon=0,ind=0,mode=PRE,plink=0,pan=0.00,wid=100.00,.8.on=0,lvl=144.
00,pon=0,ind=0,mode=PRE,plink=0,pan=0.00,wid=100.00,.9.on=0,lvl=144.00,pon=0,ind=0,mode=PRE,plink=
0,pan=0.00,wid=100.00,.10.on=0,lvl=144.00,pon=0,ind=0,mode=PRE,plink=0,pan=0.00,wid=100.00,.11.on=
0,lvl=144.00,pon=0,ind=0,mode=PRE,plink=0,pan=0.00,wid=100.00,.12.on=0,lvl=144.00,pon=0,ind=0,mode
=PRE,plink=0,pan=0.00,wid=100.00,.13.on=0,lvl=144.00,pon=0,ind=0,mode=PRE,plink=0,pan=0.00,wid=100
.00,.14.on=0,lvl=144.00,pon=0,ind=0,mode=PRE,plink=0,pan=0.00,wid=100.00,.15.on=0,lvl=144.00,pon=0
,ind=0,mode=PRE,plink=0,pan=0.00,wid=100.00,.16.on=0,lvl=144.00,pon=0,ind=0,mode=PRE,plink=0,pan=0
.00,wid=100.00,..postins.on=0,mode=FX,ins=NONE,w=0.00,$stat=,.tags="", $fdr=144.00,$mute=0,$muteovr
=0,
```

*int wGetBinaryNode (wtoken node, unsigned char \*array, int maxlen)*

The `wGetBinaryNode()` function will return in array the raw, binary data corresponding to the WING node selected with token node. The storage buffer array must be large enough to accept the data returned by the call, up to `maxlen` bytes. The function returns the number of bytes saved in array, or an error status if less or equal to 0.

Note that token node can represent a node or a parameter.

A typical use for this call is external scene management<sup>81</sup> such as in the code snippet below.

```
void WSaveS() {
    unsigned char node[2048];
    int i;
    //
    if ((fd = fopen(Scene.scn, "wb")) != NULL) {
        // Get the node data for CH_1, composed of many 0xd7<Wing data> parts
        if ((i = wGetBinaryNode(CH_1, node, 2048)) < WSUCCESS) {
            fclose(fd);
            printf("Error reading node %d\n", tarray[ta]);
            return;
        }
        fwrite(&i, sizeof(int), 1, fd);
        fwrite(node, i * sizeof(unsigned char), 1, fd);
        printf("Saved scene\n");
        fclose(fd);
    } else {
        printf("Cannot create Scene.scn\n");
    }
    return;
}
```

---

<sup>81</sup> As opposed to WING internal Show files and Scene entities (see dedicated chapter)

*int wGetBinaryData (char \*str, unsigned char \*array, int maxlen)*

The `wGetBinaryData()` function will return in `array` the raw, binary data corresponding to the WING node or parameter represented by its text description `str`. The storage buffer `array` must be large enough to accept the data returned by the call, up to `maxlen` bytes.

`str` is a string of characters enabling to select a single WING node or parameter, for example:

`"/ch"` (a node),

`"/ch.1.eq"` (a node), or

`"/ch.1.name"` (a parameter).

The function returns the number of bytes saved in `array`, or an error status if less or equal to 0.

## Meters

WING offers many measurement points along the digital audio path; As a result, there are numerous meters. As briefly presented in a table earlier in this document, every Channels, Aux, Bus, Main and Matrix strip offers no less than 8 meters: input left & right, output left & right, gate key & gain, and dyn key & gain. This alone represents 608 meters that can be retrieved, and there are even more with V2 (version 2) meters, and many more meter data from other metering points.

The network data path for getting meter values is separated from the main network communication to keep things simpler for the programmer and sound engineer.

Meter data is transmitted to a UDP port chosen by the user. When selecting which meters to receive, the user associates an ID to the request, enabling simpler identification of the received data. As soon as a valid meter request is received, WING will send back the respective meter data for 5 seconds, every approximately every 50ms. To continue or continuously receive a set of meter data, the user must renew the request for data by issuing a simple renew command containing the ID of the requested meter set.

## Meters API

wapi offers a small set of function calls to help programmers manage meter data. it hides the networking complexity and proposes a simple way of selecting what meter to get back from the digital console. Meter data will be provided back to the application in the form of a buffer of values, decoding data being left to the application.

### *int wMeterUDPPort (int wport)*

The `wMeterUDPPort()` API call enable users to select the UDP port WING will send meter data to. It also prepares the `wapi` internal network for receiving meter data and being able to return data to the user application. `wport` is a standard UDP port and must be available for receiving data. The function returns `WSUCCESS` if everything is set correctly or will return an error value if the request was not successful.

### *int wSetMetersRequest(int reqID, unsigned char \*wMid)*

`wSetMetersRequest()` must be called in order to start receiving meter data. The API associates a request ID `reqID` to a selection of meters to receive. The request ID helps renewing the request for data and sorting through potentially multiple data sets sent by the console. The `wMid` parameter holds the selection of meters that can be recovered from WING in an array of 29 bytes. Each bit (from left to right) in the array of 29 bytes represents a meter family that can be received from the console, and is shown in the table below:

byte index	bits	selection
0-4	1-40	Channel 1-40
5	1-8	Aux 1-8
6-7	1-16	Bus 1-16
8	1-4	Main 1-4
9	1-8	Matrix 1-8
10	1-8	DCA 1-8
11-12	1-16	FX proc 1-16
13-14	1-16	Source input 1-16
15-16	1-11	Output 1-11
17	1	Monitor
18	1	RTA
19-23	1-40	Channel V2 1-40
24	1-8	Aux V2 1-8
25-26	1-16	Bus V2 1-16
27	1-4	Main V2 1-4
28	1-8	Matrix V2 1-8

For example, a C source language array declaration as follows will request meters for channels 1 and 40:  
`unsigned char mbits[29] = {0x80, 0, 0, 0, 0x01, 0}; // bytes indexes 5 to 28 are 0`

*int wRenewMeters(int reqID)*

The `wRenewMeters()` API call is used to renew a previous request for meter data; This function should be called every 5 seconds maximum in order to avoid losing meter data if continuous receiving is expected. The `reqID` parameter must be previously defined with a call to `wSetMetersRequest()`. The function returns `WSUCCESS` if the request is accepted, or will return other error status values otherwise.

*int wGetMeters(unsigned char \*buf, int maxlen, int timeout)*

`wGetMeters()` will check if meter data has been received or is available. The call can be blocking or un-blocking depending on the value of `timeout`. A `timeout` of `0` will block the application in reading mode until data is available. A non-zero value of `timeout`, expressed in micro-seconds will return after the provided value and return to the caller with a value of `WZERO (0)` if no data is available or will return sooner with the actual number of bytes read available in `buf`.

The `maxlen` parameter indicates the maximum number of bytes `buf` can hold. It is the responsibility of the application to ensure `buf` is large enough to accept `maxlen` bytes.

The data returned by the `wGetMeters()` function is coded as follows:

`<reqID><[meter data group][meter data group] ... >`

Each `meter data group` is composed of several big-endian 16bits integers typically representing meter values expressed in  $1/256^{th}$  of a dB, or otherwise returned data (for ex. `Gate led` returns `0` or `1`).

The table below provides the number and origin of each meter data for each of the possible meter groups:

Group name	Contents
channel aux bus main matrix	input left input right output left output right gate key gate gain dyn key dyn gain
dca	pre fader left pre fader right post fader left post fader right
fx	input left input right output left output right state meters (1..6)
source	source group levels (i.e. local ins: 8 meters)
output	output group levels (i.e. local outs: 8 meters)
monitor	solo bus left solo bus right mon 1 left mon 1 right mon 2 left mon 2 right
rta	rta slot meters (120)

channel V2	input left
aux V2	input right
bus V2	output left
main V2	output right
matrix V2	gate key
	gate gain
	gate led
	dyn key
	dyn gain
	dyn state
	automix gain

Below is an example of buffers received after requesting meter data for channel 1 and using different sources, with Ch 1 fader set to +3dB.

As received data uses signed 16bits ([-32768...+32767]) and is expressed in 1/256<sup>th</sup> of dB, the actual meter value can be calculated as <int16>/256.

Note that fx return a different format for their meters, with value in dB = return value \* 6.0 / 2048.

```

                gate gate  dyn  dyn
                key gain  key gain
<reqID>  inL  inR  outL  outR  key gain  key gain
W→ 20 B: 00000002 9bb2 9bb2 8000 8000 9b7c 0000 8000 0000 (no input)
                -100 -100 -128 -128 -100  0 -128  0
W→ 20 B: 00000002 f9fb f9fb fcfb fcfb f9fb 0000 ee01 0000 (OSC 1kHz, -6dB)
                -6  -6  -3  -3  -6  0 -17  0
W→ 20 B: 00000002 d7fd d7fd dafd dafd d7fd 0000 aa02 0000 (OSC 1kHz, -40dB)
                -40 -40 -37 -37 -40  0 -85  0

```

## RTA test program

We show here is a small C / Windows program example showing how to get and display RTA. The scaling of meter data is tweaked in order to provide better readability, but isn't meant to be dB accurate.

```
/*
 * wrta.c
 *
 * Created on: May 9, 2020
 * Author: Patrick-Gilles Maillot
 */
#include <windows.h>
#include <stdio.h>
#include <sys/time.h>
#include "wapi.h"
#include "wext.h"

// Windows Declarations
WINBASEAPI HWND WINAPI GetConsoleWindow(VOID);
LRESULT CALLBACK WndProc(HWND, UINT, WPARAM, LPARAM);
//
HINSTANCE hInstance = 0;
HWND hwndipaddr, hwndconx;
HDC hdc;
PAINTSTRUCT ps;
MSG wMsg;
HFONT hfont;
HPEN wnpen; // no line
HBRUSH bBrush, rBrush, wBrush; // blue, red, white
int keep_running = 1; // mainloop control
int ready = 0; // ready flag after connect OK
char wingip[24] = ""; // let wapi tell us our IP
int M_id = 3; // meters request ID
int M_port = 10026; // meters UDP port

#define MAXLEN 254 // enough for RTA (244 bytes)
unsigned char buf[MAXLEN]; // data buffer
int len;

time_t before = 0; // timers
time_t now;

unsigned char mbits[29] = {0, 0, 0, 0, 0, 0, 0, 0, 0, 0, 0,
                          0, 0, 0, 0, 0, 0, 0, 0, 0x80,}; // RTA
// remaining bytes/bits to 0

//
// void wRTAMeters()
// A basic RTA; height is 128, width is 5 per freq. (120 Freqs)
void wRTAMeters(int basex, int basey, int value) {
    int basexx = basex + 5;
    int baseyy = basey + 128;
    basex++;
    // not trying to be accurate, but close to WING data behavior
    //
    SelectObject(hdc, bBrush);
    SelectObject(hdc, wnpen);
    Rectangle(hdc, basex, baseyy, basexx, baseyy - min(value, 128));
    if (value > 120) {
        SelectObject(hdc, rBrush);
    } else {
        SelectObject(hdc, wBrush);
    }
    Rectangle(hdc, basex, baseyy - value, basexx, basey);
}
//
// Windows main function and main loop
//
int WINAPI wWinMain(HINSTANCE hInstance, HINSTANCE hPrevInstance,
                   PWSTR lpCmdLine, int nCmdFile) {
    //
    union {
        unsigned char cc[2];
        short ii;
    }
}
```

```

} endian;
int          ival = 0;
float        fval;
//
WNDCLASSW wc = {0};
wc.lpszClassName = L"WING RTA";
wc.hInstance = hInstance;
wc.hbrBackground = GetSysColorBrush(COLOR_3DFACE);
wc.lpfnWndProc = WndProc;
wc.hCursor = LoadCursor(0, IDC_ARROW);
//
RegisterClassW(&wc);
CreateWindowW(wc.lpszClassName, L"wrtA - WING RTA wapi demo",
    WS_OVERLAPPED | WS_VISIBLE | WS_SYSMENU,
    220, 220, 630, 250, 0, 0, hInstance, 0);
//
// Main loop
while (keep_running) {
    if (PeekMessage(&wMsg, NULL, 0, 0, PM_REMOVE)) {
        TranslateMessage(&wMsg);
        DispatchMessage(&wMsg);
    }
    if (ready) {
        now = time(NULL); // maintain meters
        if (now > before + 4) { // by sending
            wRenewMeters(M_id); // request every less than
            before = now; // 5 seconds
        }
        // Read meters (if any data) with a timeout of 10ms
        if ((len = wGetMeters(buf, MAXLEN, 10000)) > 0) {
            for (int i = 0; i < 120; i++) {
                endian.cc[0] = buf[5 + i + i]; // get data as short
                endian.cc[1] = buf[4 + i + i]; // int
                fval = ((float)(endian.ii + 32768)/32768.);
                ival = fval * fval * 128; // approximate conversion
                wRTAMeters(10 + i * 5, 70, ival);
            }
        }
    }
}
return (int) wMsg.wParam;
}
//
//
LRESULT CALLBACK WndProc(HWND hwnd, UINT msg, WPARAM wParam, LPARAM lParam) {
    //
    char *str1[] = {" -8", "-16", "-24", "-32", "-48", "-64", "", ""};

    switch (msg) {
    case WM_CREATE:
        hwndipaddr = CreateWindow("Edit", NULL, WS_CHILD | WS_VISIBLE | WS_BORDER,
            5, 40, 120, 20, hwnd, (HMENU)0, NULL, NULL);
        hwndconx = CreateWindow("button", "Connect", WS_VISIBLE | WS_CHILD,
            5, 15, 85, 20, hwnd, (HMENU)1, NULL, NULL);
        break;
    case WM_PAINT:
        hdc = BeginPaint(hwnd, &ps);
        SelectObject(hdc, hfont);
        SetBkMode(hdc, TRANSPARENT);
        for (int i = 0; i < 8; i++) {
            TextOut(hdc, 0, 70 + i*16+10, str1[i], strlen(str1[i]));
            MoveToEx(hdc, 11, 70 + i*16+15, NULL);
            LineTo(hdc, 609, 70 + i*16+15);
        }
        break;
    case WM_COMMAND:
        if (HIWORD(wParam) == BN_CLICKED) { // user action
            switch (LOWORD(wParam)) {
            case 1:
                if (ready) {
                    keep_running = 0;
                    PostQuitMessage(0);
                } else {
                    // Connect clicked
                    if (wOpen(wingip) != WSUCCESS) exit(1);
                    SetWindowText(hwndipaddr, wingip);
                    // set port to receive UDP data and request meters for RTA
                }
            }
        }
    }
}

```



```

        if (wMeterUDPPort(M_port) != WSUCCESS) exit(1);
        if (wSetMetersRequest(M_id, mbits) != WSUCCESS) exit(1);
        ready = 1;
    }
    break;
}
}
break;
case WM_DESTROY:
    keep_running = 0;
    PostQuitMessage(0);
    break;
}
return DefWindowProcW(hwnd, msg, wParam, lParam);
}
//
//
// main program
int main(int argc, char **argv) {
    HINSTANCE hPrevInstance = 0;
    PWSTR pCmdLine = 0;
    int nCmdFile = 0;
    // Hide console window
    ShowWindow(GetConsoleWindow(), SW_HIDE);
    // Set colors, pens, fonts used in the app
    bBrush = CreateSolidBrush(RGB(10, 20, 200));
    rBrush = CreateSolidBrush(RGB(255, 30, 30));
    wBrush = CreateSolidBrush(RGB(255, 255, 255));
    wnpen = CreatePen(PS_NULL, 0, RGB(0, 0, 0));
    hfont = CreateFont(8, 0, 0, 0, FW_MEDIUM, 0, 0, 0,
        DEFAULT_CHARSET, OUT_OUTLINE_PRECIS, CLIP_DEFAULT_PRECIS,
        ANTIALIASED_QUALITY, VARIABLE_PITCH, TEXT("Arial"));
    // Launch program
    wWinMain(hInstance, hPrevInstance, pCmdLine, nCmdFile);
    wClose();
    return 0;
}

```

And the resulting displays: Sine wave signal 1kHz:

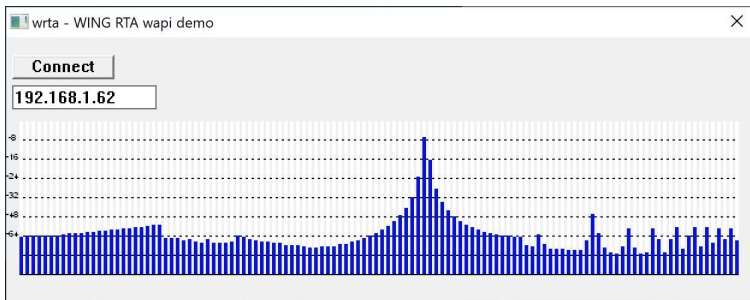

Pink noise mode:

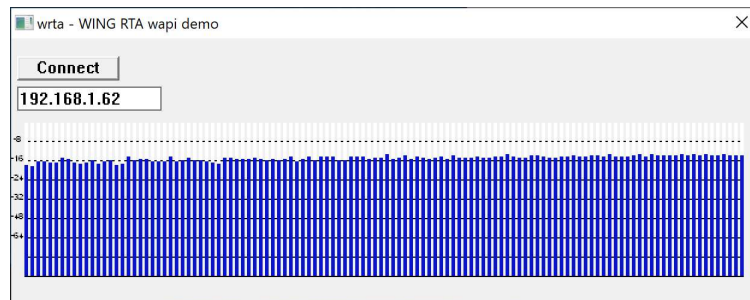

White noise mode:

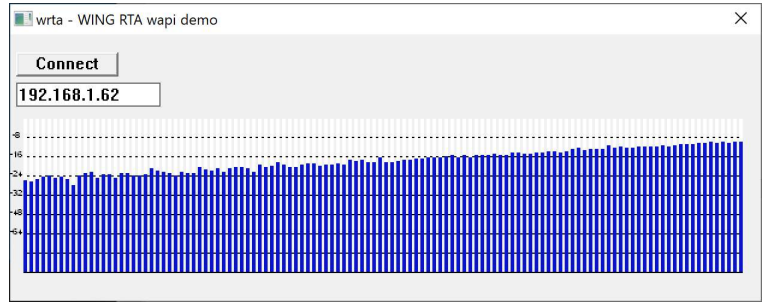

## Effects and Plugins

WING comes with an impressive number of effects, plugins and emulations that can be used on any channel without costing any FX slots. In every channel, Gate, EQ Compressor can take different processing models you can organize and change on the fly. The following pages below present the different effects and their parameters. For a detailed description of effects and plugins, please refer to the “Processing and Effects Plugin Guide”<sup>82</sup> on Behringer’s website.

### Plugins

Plugins entries are directly included with channels, busses, etc. and can either default to WING standard algorithms or adapt to alternative plugins to color your sound or fit your taste when it comes to mixing. Plugins are showing under the main JSON structure, only when instantiated. WING **Channel** audio engines enable 4 sorts of plugins: Filter, Gate, EQ and Dynamics. **Bus**, **Main** and **Matrix** audio engines support EQ and Dynamics plugins.

The choice of plugin is represented by the name (or model) of the plugin, as set under the respective “md1” token; After a console reset, the default channel Filter, Gate, EQ and Dynamics plugins will be “TILT”, “GATE”, “STD”, and “COMP”, respectively, and these can be changed to one of the multiple plugins available within the console (respecting the category they apply to of course).

The choice of plugin is represented by the name (or model) of the plugin, as set under the respective “md1” token; authorized values are:

Filters:

TILT EQ, MAXER, AP 90, AP 180

Gates:

GATE/EXPANDER, DUCKER, EVEN 88 GATE, SOUL 9000 GATE, DRAW MORE 241, BDX902 DEESSER, WAVE DESIGNER, DYNAMIC EQ, SOUL WARMTH PRE, 76 LIMITER AMP, LA LEVELER, AUTO RIDER, SOURCE EXTRACTOR, SOURCE EXTRACTOR/LA LEVELER combo

Equalizers:

WING EQ, SOUL ANALOGUE, EVEN 88 FORMANT, EVEN 84, FORTISSIMO 110, PULSAR, MACH EQ4

Compressors:

WING COMPRESSOR, WING EXPANDER, BDX 160 COMP, BDX 560 EASY, DRAW MORE COMP, EVEN COMP/LIM, SOUL 9000, SOUL BUS COMP, RED3 COMPRESSOR, 76 LIMITER AMP, LA LEVELER, FAIR KID, ETERNAL BLISS, NO-STRESSOR, WAVE DESIGNER, AUTO RIDER, PIA2250 RACK, LTA100 LEVELER, SOURCE EXTRACTOR/LA LEVELER combo

For a **wapi** program to gain access to plugin parameters, independently from the plugin being installed/loaded at a given slot, the plugin parameter names are being ‘anonymized’ to names 1..n, rather than the names that are listed with each single plugin. The actual parameter names for each separate plugin are listed in the plugin description tables later in this document and are preceded with their apparition number in the plugin parameter list; For example, to access the “range” value of plugin “GATE” used in channel 03, you would set the token value to CH\_3\_GATE\_2.

---

<sup>82</sup> See: [https://mediadl.musictribe.com/media/PLM/data/docs/POBV2/EFFECTS%20GUIDE\\_M\\_BE\\_0603-AEN\\_WING.pdf](https://mediadl.musictribe.com/media/PLM/data/docs/POBV2/EFFECTS%20GUIDE_M_BE_0603-AEN_WING.pdf)

In the small program shown below, we replace the default `Gate` and `Dynamics` plugins for Channel 1 and set their respective parameters values to arbitrary values. For this example, we use the settings of the `AUTO RIDER DYNAMICS` gate and `Dynamics` plugins; Note that the settings are different for Gate and Compression, despite the plugin carrying the same name.

```
#include <stdio.h>
#include <string.h>
//
#include "wapi.h"
#include "wext.h"
//
int main () {

    char wingip[24] = "";

    // we don't know the IP of our console..
    if (wOpen(wingip) != WSUCCESS) exit(1);
    printf("WING found at IP: %s\n", wingip);
    printf("Using version %i.%i\n", wVer()/256, wVer()&15);

    wSetTokenString(CH_1_GATE_MDL, "RIDE");           //Auto Rider Dynamics
    wSetTokenFloat(CH_1_GATE_1, -30.);               // thr
    wSetTokenFloat(CH_1_GATE_2, 0.);                 // tgt
    wSetTokenInt(CH_1_GATE_3, 20);                   // spd
    wSetTokenFloat(CH_1_GATE_4, 8.);                 // ratio
    wSetTokenFloat(CH_1_GATE_5, 0.5);                // hold
    wSetTokenFloat(CH_1_GATE_6, 6.0);                // range

    wSetTokenString(CH_1_DYN_MDL, "RIDE");           //Auto Rider Dynamics
    wSetTokenFloat(CH_1_DYN_1, 50.);                 // mix
    wSetTokenFloat(CH_1_DYN_2, 0.);                  // gain
    wSetTokenFloat(CH_1_DYN_3, -30.);                // thr
    wSetTokenFloat(CH_1_DYN_4, 0.);                  // tgt
    wSetTokenInt(CH_1_DYN_5, 20);                    // spd
    wSetTokenFloat(CH_1_DYN_6, 4.);                  // ratio
    wSetTokenFloat(CH_1_DYN_7, 0.5);                // hold
    wSetTokenFloat(CH_1_DYN_8, 3.0);                 // range

    wClose();
    return 0;
}
```

## Effects

Effects nodes are part of the main JSON structure, under the `fx.n` names, with `n`: [1...16] representing the 16 effects slots available for simultaneous use in the WIN audio processing. These 16 slots are divided in two sets of slots: 1-8 accepting premium, standard or channel effects, and slots 9-16 accepting standard and channel effects, respectively.

As in the case of plugins, the choice of effect is represented by the name (or model) of the effect, as set under the respective “`mdl`” token; authorized values are:

### Premium

NONE, EXTERNAL, HALL REVERB, ROOM REVERB, CHAMBER REVERB, PLATE REVERB, CONCERT REVERB, AMBIENCE, VSS3 REVERB, VINTAGE ROOM, VINTAGE REVERB, VINTAGE PLATE, BLUE PLATE, GATED REVERB, REVERSE REVERB, DELAY/REVERB, SHIMMER REVERB, SPRING REVERB, DIMENSION CRS, STEREO CHORUS, STEREO FLANGER, STEREO DELAY, ULTRATAP DELAY, TAPE DELAY, OILCAN DELAYB, BBD DELAY, STEREO PITCH, DUAL PITCH

### Standard

NONE, EXTERNAL, GRAPHIC EQ, PIA 560 GEQ, SPEAKER MANAGER, TRIPLE DYNAMIC EQ, C5-COMBINATOR, PRECISION LIMITER, 2-BAND DEESSER, ULTRA ENHANCER, EXCITER, PSYCHO BASS, SUB OCTAVER, SUB MONSTER, VELVET IMAGER, DOUBLE VOCAL, PICH FIX, ROTARY SPEAKER, PHASER, TREMOLO/PANNER, TAPE MACHINE, MOOD FILTER, BODYREZ, RACK AMP, UK ROCK AMP, ANGEL AMP, JAZZ CLEAN AMP, DELUXE AMP

### Channel

NONE, EXTERNAL, SOUL ANALOGUE, EVEN 88 FORMANT, EVEN 84, FORTISSIMO 110, PULSAR, MACH EQ4, EVEN CHANNEL, SOUL CHANNEL, VINTAGE CHANNEL, BUS CHANNEL, MASTERING

Effects can be used as dedicated inserts at defined locations within the audio path.

If an effect is part of a channel insert, assigning the effect to a different channel will remove the effect from its previous channel assignment. In order to create a more traditional effect bus, WING requires to dedicate one of the channels to the operation; Channels that want to use the effect bus can the send their audio (or a part of it) to the channel that carries the effect, creating an effect mix bus that will apply the same effect to several sources mixed into the effect channel and provide the resulting effect as a traditional effect return that can be routed to a bus.

As for the case of plugins, Effect types/engines are represented by their respective model’s name under the “`mdl`” OSC tag, enabling the selection (loading) of a specific in one of the 16 available effect slots.

The JSON tree dedicated to effects has the following structure:

```
“fx”: {
  “1”: {
    “mdl”: “NONE”,
    “fxmix”: 100
  }
  “2”...“16”: {}
}
```

In fact, there are a few more, read-only<sup>83</sup> elements in the actual WING structure of a non-affected effect slot, resulting in the following JSON structure:

```
“fx”: {
  “1”: {
    “mdl”: “NONE”,
    “fxmix”: 100,
    “$esrc”: 0,    external source: [0..400]
  }
}
```

---

<sup>83</sup> Read-only JSON elements start with a ‘\$’ character

```

    "$emode": M,      external mode: Mono, Stereo, Mid/Side
    "$a_chn": 0,      assign channel: [0..76]
    "$a_pos": 0       assign position: 0, 1]
  }
  "2"..."16": {}
}

```

Once an effect is assigned to a slot, the JSON structure for the respective slot is extended to include the parameters for the assigned effect. For example, installing reverb effect "ROOM" in effect slot 5 will result in the following update to the JSON of effect 5:

```

"fx": {
...
  "5": {
    "mdl": "ROOM",
    "fxmix": 100,
    "$esrc": 0,      [0..400]
    "$emode": M,     [M, ST, M/S]
    "$a_chn": 0,     [0, 1]
    "$a_pos": 0,     [0, 1]
    "pdel":          pre-delay
    "size":          room size
    "dcy":           decay
    "mult":          bass multiplier
    "damp":          damping
    "lc":            low cut
    "hc":            high cut
    "shp":           shape
    "sprd":          spread
    "diff":          diffusion
    "spin":          spin
    "ecl":           echo left
    "ecr":           echo right
    "efl":           feed left
    "efr":           feed right
  }
...
}

```

Each available effect is a sort of program including a set of dedicated parameters. When choosing a specific effect, the effect program is instantiated in one of the available slots and its parameters are mapped to the main Jason parameters lists for that effect slot, thus enabling for example up to 16 different copies<sup>84</sup> of the same effect to be active on every effect slot, with differentiated parameters for each slot.

The tables in "Appendix: Effects and Plugins' Parameters list, provide all effect names and parameters, and the parameter types associated with each known effect.

For a **wapi** program to gain access to effect parameters, independently from the effect being installed/loaded at a given slot, parameter names are being 'anonymized' to names 1..40, rather than the names that are listed with each single effect. These names listed in the tables below are preceded with their apparition number in the effect parameter list; For example, to access frequency band 125Hz of a Graphics EQ effect loaded at effect slot 12, you would set the token value to FX\_12\_9.

To set/instantiate an effect in one of the 16 WING FX slots, just set the effect model's name; The effect engine will be loaded to the effect slot, discarding a previous one if there was one already. The newly installed effect parameters will become available for tweaking the effect to your settings. Model names can be found behind the tag: "mdl" in the tables in the "Effects and Plugins' Parameters list" appendix.

<sup>84</sup> For standard effects, 8 for premium effects

In the code example below is shown the instantiation of a graphic equalizer at effect slot 1, and the manipulation of its full set of parameters; In no way an interesting EQ setting, but a simple program example on how to install an effect and set parameters.

```
#include <stdio.h>
#include <string.h>
//
#include "wapi.h"
#include "wext.h"
//
int main() {
    char wingip[24] = "";
    char *ty[] = {"std", "tru"};
    //
    // we don't know the IP of our console...
    if (wOpen(wingip) != WSUCCESS) exit(1);
    printf("WING found at IP: %s\n", wingip);
    printf("Using version %i.%i\n", wVer()/256, wVer()&15);
    //
    int j = 0;
    float f = -15.;
    wSetTokenString(FX_1_MDL, "GEQ");
    while(1) {
        for (int I = FX_1_2; I <= FX_1_32; i++)
            wSetTokenFloat(I, f); // bands 30Hz to 20kHz
        Sleep(1); // slow down!
        F += 0.25;
        if (f > 15.) {
            f = -15;
            j ^= 1;
            wSetTokenString(FX_1_1, ty[j]); // type
        }
    }
    wClose();
    return 0;
}
```

## Channel strips layers

WING offer a full customization of its control surface, enabling the standard/default settings of course but any strip can be configured to become a different one.

The goal here is not to describe how to use the feature, but to warn the programmer on a specific parameter when using channel strip layers. The typical set of parameters for Section Left, layer 1 node 1 is the following:

/ <i>\$ctl</i> /layer/L/1
/ <i>\$ctl</i> /layer/L/1/ofs
/ <i>\$ctl</i> /layer/L/1/name
/ <i>\$ctl</i> /layer/L/1/1
/ <i>\$ctl</i> /layer/L/1/1/type
/ <i>\$ctl</i> /layer/L/1/1/i
/ <i>\$ctl</i> /layer/L/1/1/dst
/ <i>\$ctl</i> /layer/L/1/1/val

The type can take different values of assigned channel strip type: CH, BUS, DCA, SEN, FX, MIDI CC. For all but the type MIDI CC, the set of attributes is receiving a fixed name. In the case of MIDI CC, the attribute *val* is anonymized as 1. Therefore, all **wapi** tokens will fit to their counterpart's name, except for *val*, as shown below:

/ <i>\$ctl</i> /layer/L/1	<i>\$CTL_LAYER_L_1</i>
/ <i>\$ctl</i> /layer/L/1/ofs	<i>\$CTL_LAYER_L_1_OFS</i>
/ <i>\$ctl</i> /layer/L/1/name	<i>\$CTL_LAYER_L_1_NAME</i>
/ <i>\$ctl</i> /layer/L/1/1	<i>\$CTL_LAYER_L_1_1</i>
/ <i>\$ctl</i> /layer/L/1/1/type	<i>\$CTL_LAYER_L_1_1_TYPE</i>
/ <i>\$ctl</i> /layer/L/1/1/i	<i>\$CTL_LAYER_L_1_1_I</i>
/ <i>\$ctl</i> /layer/L/1/1/dst	<i>\$CTL_LAYER_L_1_1_DST</i>
/ <i>\$ctl</i> /layer/L/1/1/val	<i>\$CTL_LAYER_L_1_1_1</i>



## WING MIDI

## WING MIDI Remote-Control channels use

WING offers several options and commands to remotely control the desk capabilities. Some obvious use will be for DAW control (see next Appendix: MCU [DAW BUTTONS] commands list), but more options for MIDI remote control are available:

**MIDI REMOTE CONTROL** mode can be used over DIN or USB WING MIDI control port .

**DAW CONTROL** mode can be used over DIN (limited to Control+Single MCU) or USB (Full surface) using WING MIDI DAW 1...3 ports depending on which DAW section MIDI data is coming from/going to.

**Important note on USB & MIDI:** Changing the clock rate or number of USB Audio channels on WING causes USB to disconnect for a few seconds (including MIDI). On certain operating systems, this may also reset already active MIDI connections. This could happen when loading snapshots with different clock rate or USB Audio configuration.

The tables below are for **MIDI REMOTE CONTROL**.

MIDI commands are divided by channels, most of them have been published in a Music Group Document shown below. Additional commands via **MIDI CH7, CH8** and **CH9** are available for Scene recall and Show control.

CC to Channel Mapping (for FADER, MUTE, PAN). **FADER on MIDI Ch 1, MUTE on MIDI Ch 2, PAN on MIDI Ch 3:**

CC12..31 → Channel 1..20
CC44..6 → Channel 21..40
CC70..77 → Aux 1..8
CC78..93 → Bus 1..16
CC94/95 → Main 1..2
CC102/103 → Main 3..4
CC104..111 → Matrix 1..8

DCA/Mute Groups. **DCA Fader on MIDI Ch 4, DCA Mute and Mute Group MUTE on MIDI Ch 5:**

CC12..27 → DCA 1..16
CC28..31 → Mute Group 1..4
CC44..47 → Mute Group 5..8

FX Parameter Control (**FX1 on MIDI Ch 9 .. FX8 on MIDI Ch 16**):

CC12 → Insert ON/OFF
CC13 → FX Mix
CC14 → FX Model
CC15..31 → FX Parameter 1..17
CC44..58 → FX Parameter 18..32

FX Parameter Control (**FX9 on MIDI Ch 9 .. FX16 on MIDI Ch 16**):

CC70 → Insert ON/OFF
CC71 → FX Mix
CC72 → FX Model
CC73..95 → FX Parameter 1..23
CC102..111 → FX Parameter 24..33

**Custom Controls Remote (RX only, user layers 1..16) on MIDI Ch 6:**

CC12..15 → Layer 1 Rotaries	Note0..7 → Layer 1 Buttons (upper row, lower row)
CC16..19 → Layer 2 Rotaries	Note8..15 → Layer 2 Buttons (upper row, lower row)
CC20..23 → Layer 3 Rotaries	Note16..25 → Layer 3 Buttons (upper row, lower row)
CC24..27 → Layer 4 Rotaries	Note24..31 → Layer 4 Buttons (upper row, lower row)
CC28..31 → Layer 5 Rotaries	Note32..39 → Layer 5 Buttons (upper row, lower row)
CC44..47 → Layer 6 Rotaries	Note40..47 → Layer 6 Buttons (upper row, lower row)
CC48..51 → Layer 7 Rotaries	Note48..55 → Layer 7 Buttons (upper row, lower row)
CC52..55 → Layer 8 Rotaries	Note56..63 → Layer 8 Buttons (upper row, lower row)
CC56..59 → Layer 9 Rotaries	Note64..71 → Layer 9 Buttons (upper row, lower row)
CC60..63 → Layer 10 Rotaries	Note72..79 → Layer 10 Buttons (upper row, lower row)

CC70..73 → Layer11 Rotaries	Note80..87→ Layer 11 Buttons (upper row, lower row)
CC74..77 → Layer 12 Rotaries	Note88..95→ Layer 12 Buttons (upper row, lower row)
CC78..81→ Layer13 Rotaries	Note96..103→ Layer 13 Buttons (upper row, lower row)
CC82..85 → Layer14 Rotaries	Note104..111→ Layer 14 Buttons (upper row, lower row)
CC86..89 → Layer15 Rotaries	Note112..119→ Layer 15 Buttons (upper row, lower row)
CC90..93 → Layer16 Rotaries	Note120..127→ Layer 16 Buttons (upper row, lower row)

#### MIDI Scene Change (on MIDI Ch 7)<sup>85</sup>:

CC32: bank (LSB only), PC 1..128	B62000..B620FF, C600..C67F
----------------------------------	----------------------------

#### MIDI Show Control (on MIDI Ch 8 & Ch 9):

CH8 PC 1..128 → Scene Tag #1..#128	C700..C77F
CH9 PC 1→ Scene GO	C800
CH9 PC 2→ Scene PREV	C801
CH9 PC 3→ Scene NEXT	C802
CH9 PC 4→ Scene GOPREV	C803
CH9 PC 5→ Scene GONEXT	C804

## WING MIDI SYSEX

WING also supports MIDI SYSEX messages, part of the MIDI protocol implementation in the console. SYSEX is a key component of MIDI implementation for advanced, digital desks as many commands are dedicated to controlling the desk as a surface control, rather than sending MIDI instrument notes. Standard 3 bytes MIDI messages are generally not long enough to support the full set of capabilities these new desks offer. This is made possible through the use and support of SYSEX functionality.

MIDI SYSEX messages are “system exclusive” data that can be passed using the MIDI HW and standard protocol to the console, using a specific formatting convention and system dedicated messages, sent over MIDI.

Your WING should be set to accept SYSEX data over USB or DIN. This setting is part of the in the MIDI REMOTE CONTROL tab in the SETUP→REMOTE screen.

### SYSEX Messages format

The formatting used in SYSEX data is similar to the one used for Node Data: each parameter group is separated by a ‘,’ character, the ‘/’ character represents the root of the JSON parameter tree, and ‘.’ characters are used to navigate up and down within the JSON parameter tree, as shown below:

```
/ch.1.fdr=-1,mute=0,.2.fdr=0,mute=1
```

will set channel 1 fader to -1dB, will unmute the channel, and set channel 2 fader to 0dB and mute the channel.

SYSEX communications can report error messages (see below) that can be:

```
NODE NOT FOUND
```

<sup>85</sup> See also appendix on Shows and Scenes further in this document for details on how to use MIDI scene tags

VALUE ERROR  
BUFFER OVERFLOW  
NODE IS NOT PAR  
INCOMPLETE DATA  
STACK EMPTY

## SYSEX Messages, Explained

WING MIDI SYSEX messages are built as follows:

```
F0 00 20 32 57 <cmd> <data[*]> F7
```

<data[\*]> is an arbitrary number of bytes representing the data to be sent to the console, and can be an empty string of bytes; The way data is interpreted by the console is controlled using <cmd>, a single byte as listed below:

00: ident

Will return the signature string of the console, such as returned with OSC command /?<sup>86</sup> sent to port 2223, or native identification datagram WING?<sup>87</sup> Sent to port 2222. Upon executing the command, the console will return a MIDI byte 01.

02: execute <data[\*]>

Will execute the requested command contained in or represented by <data[\*]>. <data[\*]> should contain a WING command respecting the format rules described earlier in this chapter. Upon executing the command, the console may return status 07 (Error) followed with an error message if an error occurred.

03: dump <data[\*]>

Will return the current values found for <data[\*]>. <data[\*]> should contain a WING node or command respecting the format rules described earlier in this chapter. Upon executing the command, the console will return MIDI byte 04 (OK) or 07 (Error) followed with an error message.

05: describe <data[\*]>

Will return the description of the node found at or represented by <data[\*]>. <data[\*]> should contain a WING node respecting the format rules described earlier in this chapter. Upon executing the command, the console will return a MIDI byte 06 (OK) or 07 followed with an error message.

## Examples

We give below a few examples of MIDI SYSEX commands sent to WING, with their interpretation, their resulting effect on WING, and the returned data, if any.

*cmd = 00 example:*

Sending F0 00 20 32 57 00 f7,

or cmd 00 will generate a SYSEX being returned by WING:

```
F0 00 20 32 57 01 57 49 4E 47 2C 31 39 32 2E 31 36 38
```

---

<sup>86</sup> Refer to chapter on OSC protocol

<sup>87</sup> Refer to chapter "Remote communications with WING"

```
2E 31 2E 37 31 2C 50 47 4D 2C 6E 67 63 2D 66 75 6C 6C
2C 4E 4F 5F 53 45 52 49 41 4C 2C 31 2E 30 38 2E 31 2D
30 2D 67 33 33 65 36 39 66 38 38 3A 72 65 6C 65 61 73
65 F7
```

Containing the WING signature (*your system will contain something slightly different*):  
WING,192.168.1.71,PGM,ngc-full,NO\_SERIAL,1.08.1-0-g33e69f88:release

#### cmd = 02 examples:

Sending F0 00 20 32 57 02 2F 63 68 2E 31 2E 66 64 72 3D 2D 31 2C 6D 75 74 65 3D 30 2C 2E 32  
2E 66 64 72 3D 30 2C 6D 75 74 65 3D 31 F7,  
or cmd 02 followed by /ch.1.fdr=-1,mute=0,.2.fdr=0,mute=1 will set channel 1 fader to -1, channel 2  
fader to 0 and will unmute channel 1 and mute channel 2.

Sending F0 00 20 32 57 02 2F 63 68 2E 31 2E 66 64 3D 2D 31 2C 6D 75 74 65 3D 30 2C 2E 32 2E  
66 64 72 3D 30 2C 6D 75 74 65 3D 31 F7,  
or cmd 02 followed by /ch.1.fdr=-1,mute=0,.2.fdr=0,mute=1 will return an error; note we omitted the  
"r" of "Fdr" above for channel 1. WING will reply with the following SYSEX message: F0 00 20 32 57  
07 4E 4F 44 45 20 4E 4F 54 20 46 4F 55 4E 44 F7, or error status 07, followed by NODE NOT FOUND.

#### cmd = 03 examples:

Sending F0 00 20 32 57 03 2f 61 75 78 F7,  
or cmd 03 followed by /aux, will be replied by WING with a near 28000 bytes SYSEX message  
corresponding to the following in ASCII (partial listing containing aux1 and aux8, aux2 to aux7  
included but not listed):

```
1.in.set.srcauto=0,altsrc=0,inv=0,trim=0.0,bal=0.0,.conn.grp=USB,in=1,altgrp=OFF,altin=1,..
clink=0,col=8,name=USB,icon=605,led=1,mute=0,fdr=oo,pan=0,wid=100,solosafe=0,mon=A,eq.on=0,
mix=100,lg=0.0,lf=80.2,lq=2.00,leq=SHV,lg=0.0,lf=399.1,lq=2.00,2g=0.0,2f=2k50,2q=2.00,hg=0.
0,hf=11k99,hq=2.00,heq=SHV,.preins.on=0,ins=NONE,.main.1.on=1,lvl=0.0,.2.on=0,lvl=0.0,.3.on
=0,lvl=0.0,.4.on=0,lvl=0.0,..send.1.on=0,lvl=oo,pon=0,ind=0,mode=PRE,plink=0,pan=0,wid=100,
.2.on=0,lvl=oo,pon=0,ind=0,mode=PRE,plink=0,pan=0,wid=100,.3.on=0,lvl=oo,pon=0,ind=0,mode=P
RE,plink=0,pan=0,wid=100,.4.on=0,lvl=oo,pon=0,ind=0,mode=PRE,plink=0,pan=0,wid=100,.5.on=0,l
vl=oo,pon=0,ind=0,mode=PRE,plink=0,pan=0,wid=100,.6.on=0,lvl=oo,pon=0,ind=0,mode=PRE,plink=
0,pan=0,wid=100,.7.on=0,lvl=oo,pon=0,ind=0,mode=PRE,plink=0,pan=0,wid=00,.8.on=0,lvl=oo,pon
=0,ind=0,mode=PRE,plink=0,pan=0,wid=100,.9.on=0,lvl=oo,pon=0,ind=0,mode=PRE,plink=0,pan=0,w
id=100,.10.on=0,lvl=oo,pon=0,ind=0,mode=PRE,plink=0,pan=0,wid=100,.11.on=0,lvl=oo,pon=0,ind
=0,mode=PRE,plink=0,pan=0,wid=100,.12.on=0,lvl=oo,pon=0,ind=0,mode=PRE,plink=0,pan=0,wd=100
,.13.on=0,lvl=oo,pon=0,ind=0,mode=PRE,plink=0,pan=0,wid=100,.14.on=0,lvl=oo,pon=0,ind=0,mod
e=PRE,plink=0,pan=0,wid=100,.15.on=0,lvl=oo,pon=0,ind=0,mode=PRE,plink=0,pan=0,wid=100,.16.
on=0,lvl=oo,pon=0,ind=0,mode=PRE,plink=0,pan=0,wid100,..tags=,.2.in.set.srcauto=0,[...Aux cha
nnels 2 to 7 listed...],..tags=.8.in.set.srcauto=0,altsrc=0,inv=0,trim=0.0,bal=0.0,.conn.grp=
OFF,in=1,altgrp=OFF,altin=1,..clink=0,col=1,name=,icon=0,led=1,mute=0,fdr=oo,pan=0,wid=100,
solosafe=0,mon=A,eq.on=0,mix=100,lg=0.0,lf=80.2,lq=2.00,leq=SHV,lg=0.0,lf=399.1,lq=2.00,2g=
0.0,2f=2k50,2q=2.00,hg=0.0,hf=11k99,hq=2.00,heq=SHV,.preins.on=0,ins=NONE,.main.1.on=1,lvl=
0.0,.2.on=0,lvl=0.0,.3.on=0,lvl=0.0,.4.on=0,lvl=0.0,..send.1.on=0,lvl=oo,pon=0,ind=0,mode=P
RE,plink=0,pan=0,wid=100,.2.on=0,lvl=oo,pon=0,ind=0,mode=PRE,plink=0,pan=0,wid=100,.3.on=0,
lvl=oo,pon=0,ind=0,mode=PRE,plink=0,pan=0,wid=100,.4.on=0,lvl=oo,pon=0,ind=0,mode=PRE,plink
=0,pan=0,wid=100,.5.on=0,lvl=oo,pon=0,ind=0,mode=PRE,plink=0,pan=0,wid=100,.6.on=0,lvl=oo,p
on=0,ind=0,mode=PRE,plink=0,pan=0,wid=100,.7.on=0,lvl=oo,pon=0,ind0,mode=PRE,plink=0,pan=0,
wid=100,.8.on=0,lvl=oo,pon=0,ind=0,mode=PRE,plink=0,pan=0,wid=100,.9.on=0,lvl=oo,pon=0,ind=
0,mode=PRE,plink=0,pan=0,wid=100,.10.on=0,lvl=oo,pon=0,ind=0,mode=PRE,plink=0,pan=0,wid=100
,.11.on=0,lvl=oo,pon=0,ind=0,mode=PRE,plink=0,pan=0,wid=100,.12.on=0,lvl=oo,pon=0,ind=0,mod
e=PRE,plink=0,pan=0,wid=100,.13.on=0,lvl=oo,pon=0,ind=0,mode=PRE,plink=0,pan=0,wid=100,.14.
on=0,lvl=oo,pon=0,ind=0,mode=PRE,plink=0,pan=0,wid=100,.15.on=0,lvl=oo,pon=0,ind=0,mode=PRE
,plink=0,pan=0,wid=100,.16.on=0,lvl=oo,pon=0,ind=0,mode=PRE,plink=0,pan=0,wid=100,..tags=,.
```

Sending F0 00 20 32 57 03 2F 63 68 2E 31 2E 66 64 72 F7,



## Appendices

## Appendix: Buttons (user/gpio, user/user, user/daw, user/)

WING includes a rather large set of buttons separated in different logical blocks: user/gpio, user/user, and user/daw and user. They are all managed under the \$ctl subtree of commands. As in the case of effects where the effect model sets the type and number of OSC patterns available for supporting the functionality currently in effect, the associated JSON structure varies and adapts to the necessary sets of parameters.

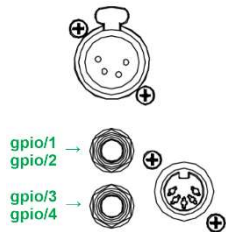

### user/gpio/1..4

This subsection covers the 4 possible GPIOs supported by WING; the actual set of usable OSC patterns available at a given time depends on the mode parameter value of the /\$ctl/user/gpio/1..4/bu/ OSC pattern represented below as <OSC b\_pattern>.

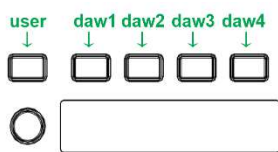

### user/user/1..4

This subsection covers the 8 user buttons supported by WING; the actual set of usable OSC patterns available at a given time depends on the mode parameter value of the /\$ctl/user/user/1..4/bu/ and the /\$ctl/user/user/1..4/bd/ OSC patterns for the 4 buttons of the upper and lower row of the button section, and represented below as <OSC b\_pattern>.

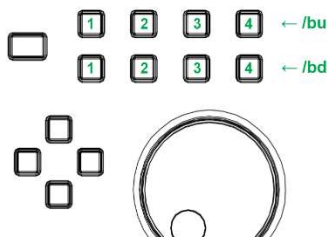

### user/daw1..4/1..4

This subsection covers the 4 possible sets of 8 DAW buttons supported by WING; the actual set of usable OSC patterns available at a given time depends on the mode parameter value of the /\$ctl/user/daw1..daw4/1..4/bu/ and the /\$ctl/user/daw1..daw4/1..4/bd/ OSC patterns for the 4 buttons of the upper and lower row of the button section, and represented below as <OSC b\_pattern>.



### user/1..16/1..4

This subsection covers the 16 possible sets of 8 user buttons and 4 user encoders supported by WING; the actual set of usable OSC patterns available at a given time depends on the mode parameter value of the /\$ctl/user/1..16/1..4/bu/, /\$ctl/user/1..16/1..4/bd/, and /\$ctl/user/1..16/1..4/enc/ OSC patterns for the 4 buttons of the upper and lower row of the button section, and the 4 encoders represented below as <OSC b\_pattern> and <OSC e\_pattern>, respectively.

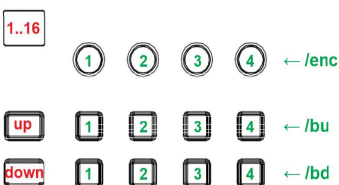

<sup>88</sup> Describing here the buttons and CC section for the standard WING, Compact and Rack version differ in the amount of CC buttons/knobs available.



The tables below list the different options for OSC patterns <OSC b\_pattern>:

mode	Command	Type	Range / Text	Description
OFF	none			OFF
MUTE	<OSC b_pattern>/ch	I	1..76	Channel number
INS1	<OSC b_pattern>/ch	I	1..76	Channel number
INS2	<OSC b_pattern>/ch	I	1..76	Channel number
MGRP	<OSC b_pattern>/mgrp	S	MGRP.1, MGRP.2,...,MGRP.8	Mute group number
DCAMUTE	<OSC b_pattern>/dca	S	DCA.1, DCA.2,...,DCA.16	DCA fader number mute
SOF	<OSC b_pattern>/ch	I	1..76	Channel number
SPILL	<OSC b_pattern>/area	S	L, C, R	Console area (left, center, right)
	<OSC b_pattern>/tgt	S	DCA1,..., DCA16, FX1,..., FX16, BUS1,..., BU16, MAIN1,..., MAIN4, MTX1,...,MTX8, AUTOX, AUTOY	Targeted group <sup>89</sup>
FXPAR	<OSC b_pattern>/fx	S	FX1,...,FX16	FX processor number
	<OSC b_pattern>/par	I	1..41	FX processor parameter number <sup>90</sup>
DAWBTN	<OSC b_pattern>/btn	S	T1,...,T20, N1,...,N9, A1,...,A16, F1,...,F8, V1,...,V15, AU1,...,AU12, SY1,...,SY10, OT1,...,OT12, E1,...,E10, SP1,..., SP6	MCU button <sup>91</sup>
DAWENC	<OSC b_pattern>/enc	S	M1P,...,M8P, E1P,...,E16P, M1,...,M8, E1,...,E16, JOG	DAW Rotary <sup>92</sup>
CHPAGE	<OSC b_pattern>/ch	I	1..76	Channel number
	<OSC b_pattern>/pg	S	HOME, INPUT, FILT, GATE, DYN, EQ, INS1, INS2, MAIN, SEND, SND.EQ	Page name
PAGE	<OSC b_pattern>/pg	S	FX, MTRS, CHINS, SRC, OUTS, SETUP, LIB, CUSTCTL, MON, 2TRK, WLIVE, MIXV, FDRV, SENDV, MGRP, LAYER	Page name
FDRPAGE	<OSC b_pattern>/area	S	L, C, R, CMPCT, RCK, EXT, VRT	Area
	<OSC b_pattern>/bank	I	1..21	Bank
VIEWPAGE	<OSC b_pattern>/area	S	L, C, R, CMPCT, RCK, EXT, VRT	Area
	<OSC b_pattern>/bank	I	1..21	Bank

<sup>89</sup> Maps to /\$ctl/layer/xxx/spidx parameters values 1..62

<sup>90</sup> 1..40 are for FX parameters, 41 is for FX Mix

<sup>91</sup> See MCU [DAW BUTTONS] commands list in Appendixes

<sup>92</sup> See MCU [DAW V-POTS] commands list in Appendixes

OTHER	<OSC b_pattern>/other	S	TBA, TBB, ALTSRC, DAWSW, MONA, MONB, MONAB, MONDIM, MONMONO, MONSWAP, MONMUTE, FDROFF, FDR-10DB, FDR0DB, AUTOX, AUTOY, CHPREV, CHNEXT, CHSOLO, BUSSOLO, MAINSOLO, MTXSOLO, CHMTR, BUSMTR, MAINMTR, MTXMTR, DCAMTR	Other functions
GPIO	<OSC b_pattern>/GPIO	S	A, B, C, D, A-P, B-P, C-P, D-P, 2S, 5S, 10S, 15S, 20S, 25S, 30S	GPIO Toggle, Push, or Power-on delay <sup>93</sup>
FSTART	<OSC b_pattern>/ch	I	1..76	Channel number
MIDICCT	<OSC b_pattern>/ch	I	1..16	MIDI channel (toggle)
	<OSC b_pattern>/cc	I	0..127	MIDI control change number
	<OSC b_pattern>/val	I	0..127	MIDI control value
MIDICCP	<OSC b_pattern>/ch	I	1..16	MIDI channel (push)
	<OSC b_pattern>/cc	I	0..127	MIDI control change number
	<OSC b_pattern>/val	I	0..127	MIDI control value
MIDINT	<OSC b_pattern>/ch	I	1..16	MIDI channel (toggle)
	<OSC b_pattern>/note	I	0..127	MIDI note
	<OSC bb_pattern>/val	I	0..127	MIDI note value
MIDINP	<OSC b_pattern>/ch	I	1..16	MIDI channel (push)
	<OSC b_pattern>/note	I	0..127	MIDI note
	<OSC b_pattern>/val	I	0..127	MIDI note value
MIDIPGM	<OSC b_pattern>/ch	I	1..16	MIDI channel
	<OSC b_pattern>/note	I	1..128	MIDI program value
USBPR	<OSC b_pattern>/usbpr	S	PSTOP, PLAY, PPAUSE, PNEXT, PPREV, RSTOP, RECORD, RPAUSE, RNEW	USB Play Rec
SDRECA	<OSC b_pattern>/sdrec	S	STOP, PLAY, REC, PAUSE, PLAYSTOP, PLAYPAUSE, ADD, PREV, NEXT, PLAYMARKER, GOMARKER, SELSESSION, PREV_S, NEXT_S	SD A recorder
SESSIONA	<OSC b_pattern>/session	S	S1..S20	SD A Session
MARKERA	<OSC b_pattern>/marker	S	M1..M20	SD A Marker
SDRECB	<OSC b_pattern>/sdrec	S	STOP, PLAY, REC, PAUSE, PLAYSTOP, PLAYPAUSE, ADD, PREV, NEXT, PLAYMARKER,	SD B recorder

<sup>93</sup> Toggle (A..D) and Push (A-P..D-P) apply to GPIO and USER CC; Delays {2S...30S) apply only to GPIO state setup time after a console power cycle.

			GOMARKER, SELSESSION, PREV_S, NEXT_S	
SESSIONB	<OSC b_pattern>/session	S	S1..S20	SD B Session
MARKERB	<OSC b_pattern>/marker	S	M1..M20	SD B Marker

The table below lists the different options for the OSC encoder pattern <OSC e\_pattern>:

mode	Command	Type	Range / Text	Description
OFF	none			OFF
FDR	<OSC e_pattern>/ch	I	1..76	Channel number
PAN	<OSC e_pattern>/ch	I	1..76	Channel number
DCA	<OSC e_pattern>/dca	S	DCA.1, DCA.2,..,DCA.16	DCA fader number
SSND	<OSC e_pattern>/send	S	BUS1,..,BUS16, MAIN1,..,MAIN4, MTX1,..,MTX8	Send to Bus, Main or Matrix number
FSND	<OSC e_pattern>/ch <OSC e_pattern>/send	I S	1..48 BUS1,..,BUS16, MAIN1,..,MAIN4, MTX1,..,MTX8	Channel number Send to Bus, Main or Matrix number
FX	<OSC e_pattern>/fx <OSC e_pattern>/par	S I	FX1,..,FX16 1..41	FX processor number FX processor parameter number <sup>94</sup>
DAWMCU	<OSC e_pattern>/mcuenc	S	M1,..,M8, E1,..,E16, JOG	DAW Rotary <sup>95</sup>
MON	<OSC e_pattern>/mon	S	A, B	Monitor selection <sup>96</sup> A: PHONES level B: SPEAKERS / MONITOR level
OTHER	<OSC e_pattern>/other	S	BRILAMP, BRIGLOW, BRIPATCH	Lamp and other lighting controls
MIDICC	<OSC e_pattern>/ch <OSC e_pattern>/cc <OSC e_pattern>/val	I I I	1..16 0..127 0..127	MIDI channel MIDI control change number MIDI control change value
SD A	<OSC e_pattern>/sdarec	S	POS, MARKER, SESSION	SD-A Recorder
SD B	<OSC e_pattern>/sdbrec	S	POS, MARKER, SESSION	SD-B Recorder

<sup>94</sup> 1..40 are for FX parameters, 41 is for FX Mix

<sup>95</sup> See MCU [DAW REMOTE MCU] commands list in Appendixes

<sup>96</sup> Note these are only 'readable' when touching the encoder, the actual setting is only possible with the potentiometer in the Monitoring/Talkback section of the console

## Appendix: Effects and Plugins' Parameters list

In the (long) tables below, we list all known/exposed effects and plugins available with the WING digital console, along with their name, type, and min/max/step/list values; We therefore present Standard Effects, Premium effects, Filter Plugins, Gate Plugins, EQ Plugins, and Compressor Plugins.

All active effects and plugins modify the JSON tree and their respective OSC patterns.

On any channel, an insert will create a processing delay of 32 samples (i.e. around 0.66ms). This is because audio is routed to a different DSP for FX processing. It is important to take this into account when mixing, as phasing effects may result from the imposed delay.



With FW 2.1, Behringer published a document on effect: the WING Effects Guide, with a description of effects and plugins that can be found on WING. This document can be found and downloaded at:



[https://mediadl.musictribe.com/media/PLM/data/docs/POBV2/EFFECTS%20GUIDE\\_M\\_BE\\_0603-AEN\\_WING.pdf](https://mediadl.musictribe.com/media/PLM/data/docs/POBV2/EFFECTS%20GUIDE_M_BE_0603-AEN_WING.pdf)



In addition to the Behringer document above, the tables below show all parameters associated to effects and plugins, including their name, type, and value range following the OSC pattern /fx/1..16/

### Effects

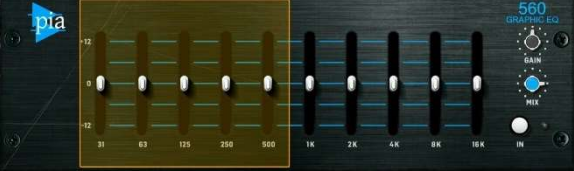
#### Standard effects

	<p>None</p> <p>0 "mdl": NONE</p>
	<p>External</p> <p>0 "mdl": EXT</p> <p>1 "egrp": str [OFF, LCL, AUX, A, B, C, SC, USB, CRD, MOD, PLAY, AES] ext grp</p> <p>2 "ein": int [1..64] ext in</p> <p>3 "emode": str [M, ST, M/S] ext mode</p> <p>4 "lat": int [0..200] latency</p> <p>5 "trim": linf [-18, 18, 361] dB, trim</p>
	<p>Graphic EQ</p> <p>0 "mdl": GEQ</p> <p>1 "type": str [STD, TRU] geq type</p> <p>2 "20": linf [-15, 15, 121] dB</p> <p>3 "25": linf [-15, 15, 121] dB</p> <p>4 "31": linf [-15, 15, 121] dB</p> <p>5 "40": linf [-15, 15, 121] dB</p> <p>6 "50": linf [-15, 15, 121] dB</p> <p>7 "63": linf [-15, 15, 121] dB</p> <p>8 "80": linf [-15, 15, 121] dB</p> <p>9 "100": linf [-15, 15, 121] dB</p> <p>10 "125": linf [-15, 15, 121] dB</p> <p>11 "160": linf [-15, 15, 121] dB</p> <p>12 "200": linf [-15, 15, 121] dB</p> <p>13 "250": linf [-15, 15, 121] dB</p> <p>14 "315": linf [-15, 15, 121] dB</p> <p>15 "400": linf [-15, 15, 121] dB</p> <p>16 "500": linf [-15, 15, 121] dB</p> <p>17 "630": linf [-15, 15, 121] dB</p> <p>18 "800": linf [-15, 15, 121] dB</p> <p>19 "1k": linf [-15, 15, 121] dB</p> <p>20 "1k25": linf [-15, 15, 121] dB</p> <p>21 "1k6": linf [-15, 15, 121] dB</p>

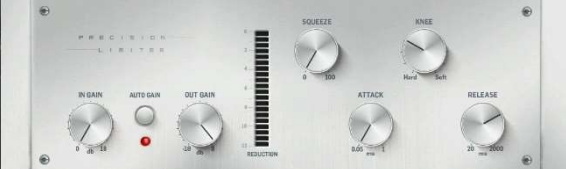
	<pre> 22 "2k":   linf [-15, 15, 121] dB 23 "2k5": linf [-15, 15, 121] dB 24 "3k15": linf [-15, 15, 121] dB 25 "4k":   linf [-15, 15, 121] dB 26 "5k":   linf [-15, 15, 121] dB 27 "6k3":  linf [-15, 15, 121] dB 28 "8k":   linf [-15, 15, 121] dB 29 "10k":  linf [-15, 15, 121] dB 30 "12k5": linf [-15, 15, 121] dB 31 "16k":  linf [-15, 15, 121] dB 32 "20k":  linf [-15, 15, 121] dB 33 "TRIM": linf [-15, 15, 121] dB </pre>
	<p>PIA 560 GEQ</p> <pre> 0 "mdl":   PIA 1 "mix":   linf [0, 125, 126] %, mix 2 "gain":  linf [-12, 12, 241] dB 3 "31":    linf [-12, 12, 241] dB 4 "63":    linf [-12, 12, 241] dB 5 "125":   linf [-12, 12, 241] dB 6 "250":   linf [-12, 12, 241] dB 7 "500":   linf [-12, 12, 241] dB 8 "1k":    linf [-12, 12, 241] dB 9 "2k":    linf [-12, 12, 241] dB 10 "4k":   linf [-12, 12, 241] dB 11 "8k":   linf [-12, 12, 241] dB 12 "16k":  linf [-12, 12, 241] dB </pre>
	<p>Triple Dynamic EQ</p> <pre> 0 "mdl":   DEQ3 1 "1-thr": linf [-60, 0, 121] dB, threshold 1 2 "1-ratio": str [1.20, 1.30, 1.50, 2.00, 3.00, 5.00, 10.00] ms, ratio 1 3 "1-att": linf [0.00, 200.00, 201] ms, att 1 4 "1-rel": logf [20.00, 4000.00, 130] ms, rel 1 5 "1-filt": str [OFF, BP, LP6, LP12, HP6, HP12] 6 "1-g":   linf [-15.00, 15.00, 301] dB, gain 1 7 "1-f":   logf [20, 20000, 961] Hz, freq 1 8 "1-q":   logf [0.44, 10.00, 181] qual 1 9 "1-mode": str [Low, high] mode 1 10 "2-thr": linf [-60, 0, 121] dB, threshold 2 11 "2-ratio": str [1.20, 1.30, 1.50, 2.00, 3.00, 5.00, 10.00] ms, ratio 2 12 "2-att": linf [0.00, 200.00, 201] ms, att 2 13 "2-rel": logf [20.00, 4000.00, 130] ms, rel 2 14 "2-filt": str [OFF, BP, LP6, LP12, HP6, HP12] 15 "2-g":   linf [-15.00, 15.00, 301] dB, gain 2 16 "2-f":   logf [20, 20000, 961] Hz, freq 2 17 "2-q":   logf [0.44, 10.00, 181] qual 2 18 "2-mode": str [Low, high] mode 2 19 "3-thr": linf [-60, 0, 121] dB, threshold 3 20 "3-ratio": str [1.20, 1.30, 1.50, 2.00, 3.00, 5.00, 10.00] ms, ratio 3 21 "3-att": linf [0.00, 200.00, 201] ms, att 3 22 "3-rel": logf [20.00, 4000.00, 130] ms, rel 3 23 "3-filt": str [OFF, BP, LP6, LP12, HP6, HP12] 24 "3-g":   linf [-15.00, 15.00, 301] dB, gain 3 25 "3-f":   logf [20, 20000, 961] Hz, freq 3 26 "3-q":   logf [0.44, 10.00, 181] qual 3 27 "3-mode": str [Low, high] mode 3 </pre>
	<p>Combinator</p> <pre> 0 "mdl":   C5-CMB 1 "thr":   linf [-40, 0, 401] dB, threshold 2 "gain":  linf [-10, 10, 201] dB, gain 3 "ratio": str [1.1, 1.2, 1.3, 1.5, 1.7, 2.0, 2.5, 3.0, 3.5, 4.0, 5.0, 7.0, 10.0, 100.0] ms, ratio 4 "slope": str [24, 48] dB/Oct, slope 5 "bandse L": int [1..5] selected band 6 "att":   linf [0, 20, 21] attack </pre>

	<pre> 7 "rel":      Logf [20, 3000, 201] ms, release 8 "arel":    int [0, 1] auto release 9 "sbc":     linf [1, 10, 10] sbc speed 10 "sbcon":  int [0, 1] sbc on 11 "thr_1":  linf [-10, 10, 201] dB, 1-THR 12 "thr_2":  linf [-10, 10, 201] dB, 2-THR 13 "thr_3":  linf [-10, 10, 201] dB, 3-THR 14 "thr_4":  linf [-10, 10, 201] dB, 4-THR 15 "thr_5":  linf [-10, 10, 201] dB, 5-THR 16 "gain_1": linf [-10, 10, 201] dB, 1-GAIN 17 "gain_2": linf [-10, 10, 201] dB, 2-GAIN 18 "gain_3": linf [-10, 10, 201] dB, 3-GAIN 19 "gain_4": linf [-10, 10, 201] dB, 4-GAIN 20 "gain_5": linf [-10, 10, 201] dB, 5-GAIN 21 "byp_1":  int [0, 1], 1-BYP 22 "byp_2":  int [0, 1], 2-BYP 23 "byp_3":  int [0, 1], 3-BYP 24 "byp_4":  int [0, 1], 4-BYP 25 "byp_5":  int [0, 1], 5-BYP 26 "width_1": linf [-50, 50, 101], 1-XOVER 27 "width_2": linf [-50, 50, 101], 2-XOVER 28 "width_3": linf [-50, 50, 101], 3-XOVER 29 "width_4": linf [-50, 50, 101], 4-XOVER 30 "width_5": linf [-50, 50, 101], 5-XOVER 31 "mix":     linf [0, 100, 101], mix 32 "\$bdsolo": int [0, 1] band solo </pre>
	<h3>Precision Limiter</h3> <pre> 0 "mdl":      LIMITER 1 "gin":     linf [0, 18, 73] dB, in gain 2 "gout":    linf [-18, 0, 73] dB out gain 3 "sqz":     int [0..100] squeeze 4 "knee":    int [0..10] knee 5 "again":   int [0, 1] auto gain 6 "att":     linf [.05, 1, 95] ms, attack 7 "rel":     Logf [20, 2000, 101] ms, release </pre>
	<h3>Speaker Manager</h3> <pre> 0 "mdl":      SPKMAN 1 "hpf":     Logf [20.00, 20000.00, 961] Hz, high 2 "hptype":  str [FLAT, BW6, BW12, BS12, LR12,                 BW18, BW24, BS24, LR24, BW48,                 LR48] type 3 "lpf":     Logf [20.00, 20000.00, 961] Hz, Low 4 "lpctype": str [FLAT, BW6, BW12, BS12, LR12,                 BW18, BW24, BS24, LR24, BW48,                 LR48] type 5 "tiltf":   Logf [100.00, 10000.00, 121] Hz, tilt 6 "tiltg":   linf [-6.00, 6.00, 121] dB, tilt gain 7 "phase":   linf [0.00, 180.00, 37] phase 8 "invert":  int [0, 1] invert 9 "dist":    linf [0.00, 5.00, 501] mtrs, distance 10 "pos":    linf [-5.00, 5.00, 1001] mtrs, pos. 11 "dyneq":  int [0, 1] deq 12 "dynthr": linf [-60.00, 0.00, 121] dB, threshold 13 "deqratio": str [1.20, 1.30, 1.50, 2.00, 3.00,                     5.00, 10.00] ratio 14 "deqatt": linf [0.00, 200.00, 201] ms, attack 15 "deqrel": Logf [20.00, 4000.00, 130] ms, release 16 "deqfilt": str [OFF, BP, LP6, LP12, HP6, HP12] 17 "deqg":   linf [-15.00, 15.00, 301] dB, gain 18 "deqf":   Logf [20.00, 20000.00, 961] Hz, freq 19 "deqq":   Logf [0.44, 10.00, 181] qual 20 "deqmode": str [low, high] mode 21 "lim":    int [0, 1] limiter 22 "limthr": linf [-24.00, 0.00, 241] dB, threshold 23 "limrms": int [0, 1] rms 24 "limrel": Logf [50.00, 2000.00, 121] ms, release </pre>



### 2-Band DeEsser

```

0 "mdl": DE-S2
1 "lo": Linf [0, 50, 51] Low
2 "hi": Linf [0, 50, 51] high
3 "los": Linf [0, 50, 51] Low (s)
4 "his": Linf [0, 50, 51] high (s)
5 "gdr": str [FEMALE, MALE] gender
6 "mode": str [STEREO, MID/SIDE] mode

```



### Ultra Enhancer

```

0 "mdl": ENHANCE
1 "stlv": Linf [-100, 100, 201] %, st Lvl
2 "Lmf": Linf [-100, 100, 201] %, Lmf spread
3 "LmvL": Linf [-100, 100, 201] %, mono Lvl
4 "st": Linf [-100, 100, 201] %, st pan
5 "m": Linf [-100, 100, 201] %, mono pan
6 "bass": Linf [0, 100, 101] %, bass gain
7 "mid": Linf [0, 100, 101] %, mid gain
8 "high": Linf [0, 100, 101] %, high gain
9 "g": Linf [-112, 12, 241] dB, gain
10 "solo": int [0, 1] solo
11 "bassf": Linf [1, 50, 50] bass freq
12 "midq": Linf [1, 50, 50] mid Q
13 "highf": Linf [1, 50, 50] high freq

```



### Exciter

```

0 "mdl": EXCITER
1 "tune": Logf [1000, 10000, 51] Hz, tune
2 "peak": Linf [0, 100, 101] %, peak
3 "zfill": Linf [0, 100, 101] %, zfill
4 "timbre": Linf [-50, 50, 101] timbre
5 "harm": Linf [0, 100, 101] %, harm
6 "mix": Linf [0, 100, 101] %, mix
7 "dry": int [0, 1] dry

```



### Psycho Bass

```

0 "mdl": P-BASS
1 "int": Linf [-24, 6, 61] dB, intensity
2 "bass": Linf [-60, 0, 121] dB, bass gain
3 "xf": Logf [32, 200. 51] Hz, X/O freq
4 "solo": int [0, 1] solo

```



### Sub Octaver

```

0 "mdl": SUB
1 "rng": str [LOW, MID, HIGH] range
2 "oct1": Linf [0, 100, 101] %, octave 1
3 "oct2": Linf [0, 100, 101] %, octave 2

```

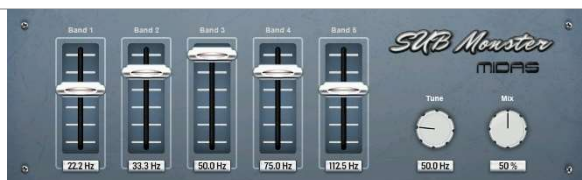

### Sub Monster

```

0 "mdl": SUB-M
1 "mix": [0, 100, 101] %mix
2 "freq": Linf [45, 67.5, 226] Hz, freq
3 "bd1": Linf [0, 100, 101] %, band 1
4 "bd2": Linf [0, 100, 101] %, band 2
5 "bd3": Linf [0, 100, 101] %, band 3
6 "bd4": Linf [0, 100, 101] %, band 4
7 "bd5": Linf [0, 100, 101] %, band 5

```





### Velvet Imager

```

0 "mdl": V_IMG
1 "wid": Linf [-1.00, 1.00, 201] width
2 "st": Linf [0.00, 100.00, 101] %, stereo
3 "gain": Linf [-6.00, 6.00, 49] dB, gain
4 "mode": str [K, VELVET] mode

```



	<p>5 <b>"deep"</b>: int [0,1] deep</p>
	<p>Double Vocal</p> <p>0 <b>"mdl"</b>: DOUBLE</p> <p>1 <b>"mode"</b>: str [TIGHT, LOOSE, GROUP, DETUNE, THICK] mode</p> <p>2 <b>"mix"</b>: linf [0, 100, 101] %, mix</p> <p>3 <b>"sprd"</b>: linf [0, 100, 101] %, spread</p>
	<p>Pitch Fix</p> <p>0 <b>"mdl"</b>: PCORR</p> <p>1 <b>"spd"</b>: linf [1, 100, 100] speed</p> <p>2 <b>"amnt"</b>: linf [0, 50, 51] amount</p> <p>3 <b>"a4"</b>: linf [410, 470, 601] A4 pitch</p> <p>4 <b>"_c"</b>: int [0, 1]</p> <p>5 <b>"_db"</b>: int [0, 1]</p> <p>6 <b>"_d"</b>: int [0, 1]</p> <p>7 <b>"_eb"</b>: int [0, 1]</p> <p>8 <b>"_e"</b>: int [0, 1]</p> <p>9 <b>"_f"</b>: int [0, 1]</p> <p>10 <b>"_gb"</b>: int [0, 1]</p> <p>11 <b>"_g"</b>: int [0, 1]</p> <p>12 <b>"_ab"</b>: int [0, 1]</p> <p>13 <b>"_a"</b>: int [0, 1]</p> <p>14 <b>"_bb"</b>: int [0, 1]</p> <p>15 <b>"_b"</b>: int [0, 1]</p>
	<p>Rotary Speaker</p> <p>0 <b>"mdl"</b>: ROTARY</p> <p>1 <b>"sw"</b>: str [STOP, SLOW, FAST]</p> <p>2 <b>"lo"</b>: Logf [.1, 3.999, 51] Hz, Lo speed</p> <p>3 <b>"hi"</b>: Logf [4, 10, 51] Hz, hi speed</p> <p>4 <b>"bal"</b>: linf [-100, 100, 201] balance</p> <p>5 <b>"mix"</b>: linf [0, 100, 101] %, mix</p> <p>6 <b>"dist"</b>: linf [0, 100, 101] distance</p> <p>7 <b>"dac"</b>: linf [0, 100, 101] %, drum accel</p> <p>8 <b>"hac"</b>: linf [0, 100, 101] %, horn accel</p>
	<p>Phaser</p> <p>0 <b>"mdl"</b>: PHASER</p> <p>1 <b>"spd"</b>: Logf [.05, 5, 201] Hz, speed</p> <p>2 <b>"phase"</b>: int [0..180] phase</p> <p>3 <b>"wave"</b>: int [-50..50] wave</p> <p>4 <b>"range"</b>: int [2..98] %, range</p> <p>5 <b>"depth"</b>: int [0..100] %, depth</p> <p>6 <b>"emod"</b>: int [-100, 100] % env mod</p> <p>7 <b>"att"</b>: Logf [10, 1000, 201] ms, attack</p> <p>8 <b>"hld"</b>: Logf [10, 2000, 201] ms, hold</p> <p>9 <b>"rel"</b>: Logf [10, 1000, 201] ms, release</p> <p>10 <b>"mix"</b>: int [0..100] %, mix</p> <p>11 <b>"stg"</b>: int [2..12] stages</p> <p>12 <b>"reso"</b>: int [0..80] %, reso</p>
	<p>Tremolo Panner</p> <p>0 <b>"mdl"</b>: PANNER</p> <p>1 <b>"att"</b>: Logf [10, 1000, 201] ms, attack</p> <p>2 <b>"hld"</b>: Logf [10, 2000, 201] ms, hold</p> <p>3 <b>"rel"</b>: Logf [10, 1000, 201] ms, release</p> <p>4 <b>"espd"</b>: int [0..100] %, env&gt;depth</p> <p>5 <b>"edep"</b>: int [0..100] %, env&gt;depth</p> <p>6 <b>"spd"</b>: Logf [.05, 5, 201] Hz, speed</p> <p>7 <b>"phase"</b>: int [0..180] phase</p> <p>8 <b>"wave"</b>: int [-50..50] wave</p> <p>9 <b>"depth"</b>: int [0..100] %, depth</p>





### Tape Machine

- 0 "mdl": TAPE
- 1 "drv": Linf [-12, 12, 97] dB, drive
- 2 "spd": Logf [7.5, 30, 65]
- 3 "Low": int [0, 1] Low bump
- 4 "hi": int [0, 1] high shelv
- 5 "out": Linf [-12, 12, 97] dB, out gains s



### Mood Filter

- 0 "mdl": MOOD
- 1 "fbase": Logf [20, 15000, 101] Hz, base
- 2 "filt": str [LP, HP, BP, NOTCH] type
- 3 "slope": str [12, 24] slope
- 4 "reso": Linf [0, 10, 101] reso
- 5 "drv": Linf [0, 10, 101] drive
- 6 "env": Linf [-100, 100, 201] %, env
- 7 "att": Logf [10, 250, 101] ms, attack
- 8 "hld": Logf [1, 500, 101] ms, hold
- 0 "rel": Logf [1, 500, 101] ms, release
- 1 "mix": Linf [0, 10, 101] %, mix
- 2 "lfo": Linf [Linf [0, 10, 101] %, lfo
- 6 "spd": Logf [.05, 20, 301] Hz, speed
- 7 "phase": int [0..180] phase
- 8 "wave": str [TRI, SIN, SAW+, SAW-, RMP, SQU, RND] lfo wave



### Bodyrez

- 0 "mdl": BODY
- 1 "body": Linf [0, 100, 101] body



### Rack Amp

- 0 "mdl": RACKAMP
- 1 "pre": Linf [0, 10, 101] preamp
- 2 "buzz": Linf [0, 10, 101] buzz
- 3 "punch": Linf [0, 10, 101] punch
- 4 "crunch": Linf [0, 10, 101] crunch
- 5 "drive": Linf [0, 10, 101] drive
- 6 "out": Linf [0, 10, 101] out gain
- 7 "Leq": Linf [0, 10, 101] low eq
- 8 "heq": Linf [0, 10, 101] high eq
- 9 "cab": int [0, 1] cab sim



### UK Rock Amp



- 0 "mdl": UKROCK
- 1 "gain": Linf [0, 10, 101] gains
- 2 "bass": Linf [0, 10, 101] bass
- 3 "mid": Linf [0, 10, 101] middle
- 4 "treb": Linf [0, 10, 101] trebble
- 5 "pres": Linf [0, 10, 101] presence
- 6 "mstr": Linf [0, 10, 101] master
- 7 "out": Linf [0, 10, 101] out gain
- 8 "sag": Linf [0, 10, 101] sag
- 9 "cab": int [0, 1] cab sim





### Angel Amp

- 0 "mdl": ANGEL
- 1 "gain": Linf [0, 10, 101] gains
- 2 "bass": Linf [0, 10, 101] bass
- 3 "mid": Linf [0, 10, 101] middle
- 4 "treb": Linf [0, 10, 101] trebble
- 5 "pres": Linf [0, 10, 101] presence
- 6 "mstr": Linf [0, 10, 101] master
- 7 "out": Linf [0, 10, 101] out gain
- 8 "sag": Linf [0, 10, 101] sag
- 9 "cab": int [0, 1] cab sim

	<p>10 "midb": int [0, 1] mid boost  11 "bri": int [0, 1] bright  12 "bt": int [0, 1] bottom</p>
	<p>Jazz Clean Amp</p> <p>0 "mdl": JAZZC  1 "vol": linf [0, 10, 101] volume  2 "bass": linf [0, 10, 101] bass  3 "mid": linf [0, 10, 101] middle  4 "treb": linf [0, 10, 101] trebble  5 "out": linf [0, 10, 101] out gain  6 "bri": int [0, 1] bright  7 "cab": int [0, 1] cab sim</p>
	<p>Deluxe Amp</p> <p>0 "mdl": DELUXE  1 "vol": linf [1, 10, 91] volume  2 "bass": linf [1, 10, 91] bass  4 "treb": linf [1, 10, 91] trebble  5 "out": linf [1, 10, 91] out gain  6 "sag": linf [1, 10, 91] sag  7 "cab": int [0, 1] cab sim</p>
	<p>Soul Analogue</p> <p>0 "mdl": SOUL  1 "mix": linf [0, 125, 126] %, mix  2 "lf": linf [0, 10, 101] lo freq  3 "lg": linf [-5, 5, 101] lo gain  4 "lmf": linf [0, 10, 101] lm freq  5 "lmf3": int [0, 1] lm /3  6 "lmq": linf [0, 10, 101] lm q  7 "lmg": linf [-5, 5, 101] lm gain  8 "hmf": linf [0, 10, 101] hm freq  9 "hmf3": int [0, 1] hm x3  10 "hmq": linf [0, 10, 101] hm q  11 "hmg": linf [-5, 5, 101] hm gain  12 "hf": linf [0, 10, 101] hf freq  13 "hg": linf [-5, 5, 101] hf gain</p>
	<p>Even 88 Formant</p> <p>0 "mdl": E88  1 "mix": linf [0, 125, 126] %, mix  2 "lf": linf [0, 10, 101] lf freq  3 "lg": linf [-5, 5, 101] lf gain  4 "lq": str [LOW, HIGH] lf q  5 "lt": str [BELL, SHELV] lf type  6 "lmf": linf [0, 10, 101] lm freq  7 "lmg": linf [-5, 5, 101] lm gain  8 "lmq": linf [0, 10, 101] lm q  9 "hmf": linf [0, 10, 101] hm freq  10 "hmq": linf [-5, 5, 101] hm gain  11 "hmq": linf [0, 10, 101] hm q  12 "hf": linf [0, 10, 101] hf freq  13 "hg": linf [-5, 5, 101] hf gain  14 "hq": str [LOW, HIG] hf q  15 "ht": str [BELL, SHELV] hf type</p>
	<p>Even 84</p> <p>0 "mdl": E84  1 "mix": linf [0, 125, 126] %, mix  2 "g": linf [-20, 20, 81] dB, gain  3 "lf": str [OFF, 35, 60, 110, 220] lf freq  4 "lg": linf [-5, 5, 101] lf gain  5 "mf": str [OFF, 350, 700, 1k6, 3k2, 4k8, 7k2] mid freq  6 "mq": linf [-5, 5, 101] mid gain  7 "mq": str [LOW, HIGH] mid q  8 "hf": str [10k, 12k, 16k, OFF] hf freq  9 "hg": linf [-5, 5, 101] hf gain</p>

	<p>Fortissimo110</p> <pre> 0 "mdl": F110 1 "mix": Linf [0, 125, 126] %, mix 2 "peq": int [0, 1] peq on 3 "Lmf": Linf [0, 10, 101] Lm freq 4 "Lmg": Linf [-5, 5, 101] Lm gain 5 "Lmq": Linf [0, 10, 101] Lm q 6 "Lmf3": int [0, 1] Lm /3 7 "hmf": Linf [0, 10, 101] hm freq 8 "hmg": Linf [-5, 5, 101] hm gain 9 "hmq": Linf [0, 10, 101] hm q 10 "hmf3": int [0, 1] hm x3 11 "shv": inf [0, 1] shv on 12 "Lf": str [33, 56, 95, 160, 270, 460] Lf freq 13 "Lg": Linf [-5, 5, 101] Lf gain 14 "hf": str [3k3, 4k7, 6k8, 10k, 15k, 18k] hf freq 15 "hg": Linf [-5, 5, 101] hf q 16 "g": Linf [-18, 18, 73] gain </pre>
	<p>Pulsar</p> <pre> 0 "mdl": PULSAR 1 "mix": Linf [0, 125, 126] %, mix 2 "eq1": int [0, 1] eq1 on 3 "1lb": Linf [0, 10, 101] Lf boost 4 "1latt": Linf [0, 10, 101] Lf att 5 "1Lf": str [20, 30, 60, 100] Hz, Lf freq 6 "1hw": Linf [0, 10, 101] hf wid 7 "1hb": Linf [0, 10, 101] hf boost 8 "1hf": str [3k, 4k, 5k, 8k, 10k, 12k, 16k] Hz, hf freq 9 "1hatt": Linf [0, 10, 101] hf att 10 "1hattf":str [5k, 10k, 20k] hf att 11 "eq5": inf [0, 1] eq5 on 12 "5Lb": Linf [0, 10, 101] Lm boost 13 "5Lf": str [200, 300, 500, 700, 1k] Hz, Lf freq 14 "5md": Linf [0, 10, 101] mid dip 15 "5mf": str [200, 300, 500, 700, 1k, 1k5, 2k, 3k, 4k, 5k, 7k] Hz, mid freq 16 "5hb": Linf [0, 10, 101] HM boost 17 "5hf": str [1k5, 2k, 3k, 4k, 5k] Hz, hf freq </pre>
	<p>Mach EQ4</p> <pre> 0 "mdl": MACH4 1 "mix": Linf [0, 125, 126] %, mix 2 "sub": Linf [-5, 5, 101] sub 3 "40": Linf [-5, 5, 101] 40 4 "160": Linf [-5, 5, 101] 160 5 "650": Linf [-5, 5, 101] 650 6 "2k5": Linf [-5, 5, 101] 2k5 7 "air": Linf [0, 10, 101] air 8 "airm": str [OFF, 2k5, 5k, 10k, 20k, 40k] air mode 9 "again": int [0, 1] auto </pre>

## Premium effects

	<p>None</p> <p>0 "mdl": NONE</p>
	<p>External</p> <p>0 "mdl": EXT</p> <p>1 "egrp": str [OFF, LCL, AUX, A, B, C, SC, USB, CRD, MOD, PLAY, AES] ext grp</p> <p>2 "ein": int [1..64] ext in</p> <p>3 "emode": str [M, ST, M/S] ext mode</p> <p>4 "lat": int [0..200] latency</p> <p>5 "trim": linf [-18, 18, 361] dB, trim</p>
	<p>Hall Reverb</p> <p>0 "mdl": HALL</p> <p>1 "pdel": int [0..200] ms, pre-delay</p> <p>2 "size": int [0..100] hall size</p> <p>3 "dcy": logf [.2, 5, 101] s, decay</p> <p>4 "mult": logf [.5, , 101] bass multiplier</p> <p>5 "damp": logf [1k, 20k, 51] Hz, damping</p> <p>6 "lc": logf [20, 400, 51] Hz, low cut</p> <p>7 "hc": logf [200, 20k, 51] Hz, high cut</p> <p>8 "shp": linf [0, 50, 51] shape</p> <p>9 "sprd": int [0..50] spread</p> <p>10 "diff": int [1..30] diffusion</p> <p>11 "mspd": int [0..100] mod speed</p>
	<p>Room Reverb</p> <p>0 "mdl": R-OOM</p> <p>1 "pdel": int [0..200] ms, pre-delay</p> <p>2 "size": linf [4, 76, 145] m, room size</p> <p>3 "dcy": logf [.3, 25, 101] s, decay</p> <p>4 "mult": logf [.25, 4, 101] bass multiplier</p> <p>5 "damp": logf [1k, 20k, 51] Hz, damping</p> <p>6 "lc": logf [20, 400, 51] Hz, low cut</p> <p>7 "hc": logf [200, 20k, 51] Hz, high cut</p> <p>8 "shp": linf [0, 250, 51] shape</p> <p>9 "sprd": int [0..50] spread</p> <p>10 "diff": int [0..100] diffusion</p> <p>11 "spin": int [0..100] spin</p> <p>12 "ecl": linf [0, 1200, 1201] ms, echo left</p> <p>13 "ecr": linf [0, 1200, 1201] ms, echo right</p> <p>14 "efl": linf [-100, 100, 201] %, feed left</p> <p>15 "efr": linf [-100, 100, 201] %, feed right</p>
	<p>Chamber Reverb</p> <p>0 "mdl": CHAMBER</p> <p>1 "pdel": int [0..200] ms, pre-delay</p> <p>2 "size": linf [4, 76, 145] m, room size</p> <p>3 "dcy": logf [.3, 25, 101] s, decay</p> <p>4 "mult": logf [.25, 4, 101] bass multiplier</p> <p>5 "damp": logf [1k, 20k, 51] Hz, damping</p> <p>6 "lc": logf [20, 400, 51] Hz, low cut</p> <p>7 "hc": logf [200, 20k, 51] Hz, high cut</p> <p>8 "shp": linf [0, 250, 51] shape</p> <p>9 "sprd": int [0..50] spread</p> <p>10 "diff": int [0..100] diffusion</p> <p>11 "spin": int [0..100] spin</p> <p>12 "ecl": linf [0, 300, 301] ms, echo left</p> <p>13 "ecr": linf [0, 300, 301] ms, echo right</p> <p>14 "eLL": fader lvl dB, echo left</p> <p>15 "eLr": fader lvl dB, echo right</p>





### Plate Reverb

0 "mdl": PLATE  
 1 "pdel": int [0..200] ms, pre-delay  
 2 "size": linf [4, 76, 145] m, room size  
 3 "dcy": logf [.3, 25, 101] s, decay  
 4 "mult": logf [.25, 4, 101] bass multiplier  
 5 "damp": logf [1k, 20k, 51] Hz, damping  
 6 "lc": logf [20, 400, 51] Hz, low cut  
 7 "hc": logf [200, 20k, 51] Hz, high cut  
 8 "att": linf [0, 100, 101] attack  
 9 "sprd": int [0..50] spread  
 10 "diff": int [0..100] diffusion  
 11 "spin": int [0..100] spin  
 12 "ecl": linf [0, 1200, 1201] ms, echo left  
 13 "ecr": linf [0, 1200, 1201] ms, echo right  
 14 "efl": linf [-100, 100, 201] %, feed left  
 15 "efr": linf [-100, 100, 201] %, feed right



### Concert Reverb

0 "mdl": CONCERT  
 1 "pdel": int [0..200] ms, pre-delay  
 2 "size": linf [20, 76, 113] m, room size  
 3 "dcy": logf [.3, 29, 51] s, decay  
 4 "mult": logf [.25, 4, 101] bass multiplier  
 5 "damp": logf [1k, 20k, 51] Hz, damping  
 6 "lc": logf [20, 400, 51] Hz, low cut  
 7 "hc": logf [200, 20k, 51] Hz, high cut  
 8 "shp": linf [0, 50, 51] shape  
 9 "sprd": int [0..50] spread  
 10 "diff": int [1..16] diffusion  
 11 "depth": int [0, 100] depth  
 12 "rfl": linf [0, 1200, 1201] ms, refl. left  
 13 "rfr": linf [0, 1200, 1201] ms, refl. right  
 14 "rflL": fader lvl dB, reflection left  
 15 "rflR": fader lvl dB, reflection right  
 16 "spin": int [0..100] spin  
 17 "crs": int [1..100] chorus



### Ambiance

0 "mdl": AMBI  
 1 "pdel": int [0..200] ms, pre-delay  
 2 "size": linf [2, 100, 99] m, room size  
 3 "dcy": logf [.2, 7.3, 101] s, decay  
 4 "tail": int [0..100] tail gain  
 5 "damp": logf [1k, 20k, 51] Hz, damping  
 6 "diff": int [1..30] diffusion  
 7 "mod": int [1..100] modulation speed  
 8 "lc": logf [20, 400, 51] Hz, low cut  
 9 "hc": logf [200, 20k, 51] Hz, high cut

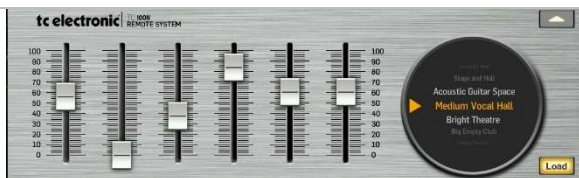







### VSS3 Reverb

0 "mdl": VSS3  
 1 "preset": str [Build, Small Booth, Home Room, Dialog Alley, Small Wood Room, A Small Room, Intimate Studio, Small Room, Tight & Natural, Room Conversation, Furnished Room 2, Studio 20x20 ft, Drew Room, Piano Close, Clear Guitar Room, Wide Ambient Chamber, Small Dense Hall, Slap Hall, Acoustic Gtr Ambience, Clear Room, Livingroom, Band Rehearsal Room, The Studio, In The Room, Studio 40x40 ft, Hit Room, Ambient Hall, Stage and Hall, Acoustic Guitar Space, Medium Vocal Hall, Bright Theatre, Big Empty Club, Venue Warm 1, Concert 1, Bright Guitar Hall, Concert Arena, Concert Piano, Piano Hall 1st Row, Empty Arena, Ballad Vocal

	<p>Hall, Grand Vocal Hall, Large Warm Hall, Back There, WoodHall, Church, Sound Col, 5000 Hall, Cathedral, Large Church, Medium Church, Warm Cathedral, Cologne Cathedral, Drum Plate Stuff, Drum Wood Plate, Piano Plate, Stairway Plate, Slapback Plate, Ambient Plate, Silky Gold Plate, Gold Plate, EMT 141, Leader Of The Band, VocalDry, Vocal Room, VocalWet, Slapback Vox 1, Vocal Hall 1, Vocal Chamber, Bright Male Vox, Vocal Bright, Vocal Deep, Vocal Female, Vocal Deep Male, Large Vocal Hall, Kick &amp; Bass Ambience, Drum Room, Small Perc Room, Drum Room Xpander, Bright Shoe Gaze Snare, Snare Room Bright, Tom-Tom Reverb, Bossa Nova Perc Room, Hard Drum Space, Puk Drum Ambience, Overhead Mics, Dance Snare, Drum Perc Soft 1, Perc Straight Tail, Store Room, Studio Small, The Alley, Near The Wall, WoodFlr, Large Office, Conference Room, Dance Studio, Forest 2, StoneWall, Venue 1, Small Stairway, Forest 1, Airport PA, Small Tower Hall, On The Street, Dark Tunnel, Empty Nightclub, Parking Garage, Parking Distant, Long Swimmingpool] preset</p> <p>2 "Load": int [0, 1] Load</p> <p>3 "erpdly": linf [0, 100, 101] ms, er pdly</p> <p>4 "ertype": str [ROYAL, THEATRE, CHURCH, GAS, CONCERT, ROYAL2, V1-NEAR, V2-HARD, V3-SPREAD, V4-BUILD, V5-RANDOM, SLAP, CAR, PHONEBTH, BATHROOM, CONFRM9, CONFRM30, GARAGE, SWIMSTDM, AIRPORT, STREET, ALLEY, PIAZA, FOREST], er type</p> <p>5 "ersize": str [SML, MED, LRG] er size</p> <p>6 "erpos": str [NEAR, DIST] er position</p> <p>7 "erbal": linf [-100, 100, 201], er balance</p> <p>8 "erlc": logf [20, 400, 51] Hz, er low cut</p> <p>9 "ercol": linf [-40, 40, 81] er color</p> <p>10 "erlvl": fader lvl dB, er level</p> <p>11 "rvtype": str [SMOOTH, NATURAL, ALIVE, FAST, X-WIDE, ALIVE2] rev type</p> <p>12 "rvwide": str [NARROW, NORMAL, WIDE, X-WIDE] rev wide</p> <p>13 "rvpdly": linf [0, 200, 201] ms, rev pdly</p> <p>14 "dcy": linf [.1, 20, 280] s, decay</p> <p>15 "diff": linf [-50, 50, 101] diffuse</p> <p>16 "rvbal": linf [-100, 100, 201] balance</p> <p>17 "rvlvl": fader lvl dB, reverb level</p> <p>18 "ldcy": linf [.1, 2.5, 25] low decay</p> <p>19 "lmdcy": linf [.1, 2.5, 25] lowmid decay</p> <p>20 "hmdcy": linf [.1, 2.5, 25] mid decay</p> <p>21 "hdcy": linf [.1, 2.5, 25] high decay</p> <p>22 "hsoft": linf [-50, 50, 101] high soft</p> <p>23 "lxo": logf [20, 500, 113] Hz, low xover</p> <p>24 "mxo": logf [200, 2000, 81] Hz, mid xover</p> <p>25 "hxo": logf [500, 20000, 105] Hz, high xover</p> <p>26 "lshv": logf [20, 200, 81] Hz, low shelf</p> <p>27 "lsdmp": linf [0, -18, 37] dB, low damp</p> <p>28 "hcut": logf [20, 20000, 241] Hz, high cut</p> <p>29 "mtype": str [A, B, C, D, E, F] modulation type</p> <p>30 "mrate": linf [-100, 100, 201] modulation rate</p> <p>31 "mwid": linf [0, 200, 201] modulation width</p> <p>32 "view": int [0, 1] view</p>
--	---

	<p>Vintage Room</p> <ul style="list-style-type: none"> <li>0 "mdl": V-ROOM</li> <li>1 "pdel": int [0..200] ms, pre-delay</li> <li>2 "size": int [0..50] size</li> <li>3 "dcy": Logf [.1, 20, 101] s, decay</li> <li>4 "dens": linf [1, 30, 30] density</li> <li>5 "erlvl": linf [0, 100, 101] %, Early Level</li> <li>6 "lmult": Logf [.1, 10, 101] low multiplier</li> <li>7 "hmult": Logf [.1, 10, 101] high multiplier</li> <li>8 "lc": Logf [20, 400, 51] Hz, low cut</li> <li>9 "hc": Logf [200, 20k, 51] Hz, high cut</li> <li>10 "frz": int [0, 1] freeze</li> </ul>
	<p>Vintage Reverb,</p> <ul style="list-style-type: none"> <li>0 "mdl": V-REV</li> <li>1 "pdel": int [0..120] ms, pre-delay</li> <li>2 "dcy": linf [.4, 4.5, 83] s, decay</li> <li>3 "lmult": Logf [.5, 2, 51] low multiplier</li> <li>4 "hmult": Logf [.25, .67, 51] high multiplier</li> <li>5 "mod": int [0..100] modulation speed</li> <li>6 "lc": Logf [20, 400, 51] Hz, low cut</li> <li>7 "hc": Logf [5000, 20k, 31] Hz, high cut</li> <li>8 "out": str [FRONT, REAR] output</li> <li>9 "trans": int [0..1] transformer</li> </ul>
	<p>Vintage Plate</p> <ul style="list-style-type: none"> <li>0 "mdl": V-PLATE</li> <li>1 "pdel": int [0..250] ms, pre-delay</li> <li>2 "dcy": linf [1, 6, 101] s, decay</li> <li>3 "lc": Logf [20, 400, 51] Hz, low cut</li> <li>4 "col": linf [-20, 20, 42] color</li> </ul>
	<p>Blue Plate</p> <ul style="list-style-type: none"> <li>0 "mdl": BPLATE</li> <li>1 "pdel": int [0..200] ms, pre delay</li> <li>2 "size": int [0..100] ms, size</li> <li>3 "dcy": Logf [0.2, 5, 101] s, decay</li> <li>4 "mult": Logf [0.5, 2, 51] bass multiplier</li> <li>5 "damp": Logf [1000, 20000, 51] Hz, damping</li> <li>6 "lc": Logf [20, 400, 51] Hz, low cut</li> <li>7 "hc": Logf [200, 20000, 51] Hz, high cut</li> <li>8 "xover": Logf [20, 500, 51] Hz, xover</li> <li>9 "mdep": linf [1, 50, 50] modulation depth</li> <li>10 "msdp": int [0..100] modulation speed</li> <li>11 "diff": int [1..30] diffusion</li> </ul>
	<p>Gated Reverb</p> <ul style="list-style-type: none"> <li>0 "mdl": GATED</li> <li>1 "pdel": int [0..200] ms, pre-delay</li> <li>2 "att": int [4..30] attack</li> <li>3 "dcy": Logf [.14, 1, 101] s, decay</li> <li>4 "dens": int [0..100] density</li> <li>5 "diff": int [0..100] diffusion</li> <li>6 "sprd": int [0..50] spread</li> <li>7 "lc": Logf [20, 400, 51] Hz, low cut</li> <li>8 "hfs": Logf [200, 20k, 51] Hz, high freq</li> <li>9 "hsg": linf [-30, 0, 61] dB, high gain</li> </ul>
	<p>Reverse Reverb</p> <ul style="list-style-type: none"> <li>0 "mdl": REVERSE</li> <li>1 "pdel": int [0..200] ms, pre-delay</li> <li>2 "rise": int [4..50] rise</li> <li>3 "dcy": Logf [.14, 1, 101] s, decay</li> <li>4 "diff": int [0..30] diffusion</li> <li>5 "sprd": int [0..100] spread</li> <li>6 "lc": Logf [20, 400, 51] Hz, low cut</li> <li>7 "hfs": Logf [200, 20k, 51] Hz, high freq</li> </ul>

	8 "hsg": Linf [-30, 0, 61] dB, high gain
	<p>Delay/Reverb</p> <ul style="list-style-type: none"> <li>0 "mdl": DEL/REV</li> <li>1 "time": Linf [0, 3000, 3000] ms, time</li> <li>2 "feed": Linf [0, 100, 101] %, feed</li> <li>3 "fhc": Logf [200, 2000, 51] Hz, feed HC</li> <li>4 "dly": Linf [0, 100, 101] %, delay</li> <li>5 "d2r": Linf [0, 100, 101] %, delay→rev</li> <li>6 "pdel": int [0..200] ms, pre delay</li> <li>7 "size": int [2..100] size</li> <li>8 "dcy": Logf [1.1, 5, 51] s, decay</li> <li>9 "damp": Logf [1000, 20k, 51] Hz, damp</li> <li>10 "rlc": Logf [20, 400, 51] Hz, rev LC</li> <li>11 "i2r": Linf [0, 100, 101] %, in→rev</li> </ul>
	<p>Shimmer Reverb</p> <ul style="list-style-type: none"> <li>0 "mdl": SHIMMER</li> <li>1 "pdel": int [0..250] ms, pre delay</li> <li>2 "size": int [2..50] size</li> <li>3 "dcy": Logf [1, 20, 101] s, decay</li> <li>4 "lc": Logf [25, 250, 51] Hz, low cut</li> <li>5 "hc": Logf [500, 7000, 51] Hz, high cut</li> <li>6 "damp": Linf [0, 100, 101] %, damp</li> <li>7 "shim": Linf [0, 100, 101] %, shimmer</li> <li>8 "shine": Linf [0, 100, 101] %, shine</li> </ul>
	<p>Spring Reverb</p> <ul style="list-style-type: none"> <li>0 "mdl": SPRING</li> <li>1 "dcy": Logf [1.5, 6, 101] s, decay</li> <li>2 "dens": Linf [1, 30, 30] density</li> <li>3 "low": Linf [1, 50, 50] bass</li> <li>4 "high": Linf [1, 50, 50] trebble</li> </ul>
	<p>Dimension CRS</p> <ul style="list-style-type: none"> <li>0 "mdl": DIMCRS</li> <li>1 "sw1": int [0, 1] sw1</li> <li>2 "sw2": int [0, 1] sw2</li> <li>3 "sw3": int [0, 1] sw3</li> <li>4 "sw4": int [0, 1] sw4</li> <li>5 "in": str [MONO, STEREO] input</li> <li>6 "drysw": int [0, 1] dry</li> </ul>
	<p>Stereo Chorus</p> <ul style="list-style-type: none"> <li>0 "mdl": CHORUS</li> <li>1 "lc": Logf [20, 400, 51] Hz, LC</li> <li>2 "hc": Logf [200, 20000, 51] Hz, HC</li> <li>3 "wave": Linf [0, 100, 101] waveform</li> <li>4 "phase": Linf [0, 100, 101] phase</li> <li>5 "mix": Linf [0, 100, 101] %, mix</li> <li>6 "dlyL": Linf [5, 50, 226] ms, dely L</li> <li>7 "dlyR": Linf [5, 50, 226] ms, dely R</li> <li>8 "depl": Linf [0, 100, 101] %, depth L</li> <li>9 "depr": Linf [0, 100, 101] %, depth R</li> <li>10 "sprd": Linf [0, 100, 101] %, spread</li> <li>11 "spd": Logf [.05, 5, 201] Hz, speed</li> </ul>
	<p>Stereo Flanger</p> <ul style="list-style-type: none"> <li>0 "mdl": CHORUS</li> <li>1 "lc": Logf [20, 400, 51] Hz, LC</li> <li>2 "hc": Logf [200, 20000, 51] Hz, HC</li> <li>3 "flc": Logf [20, 400, 51] Hz, feed LC</li> <li>4 "fhc": Logf [200, 20000, 51] Hz, feed HC</li> <li>5 "mix": Linf [0, 100, 101] %, mix</li> <li>6 "dlyL": Linf [5, 20, 196] ms, dely L</li> <li>7 "dlyR": Linf [5, 20, 196] ms, dely R</li> <li>8 "depl": Linf [0, 100, 101] %, depth L</li> <li>9 "depr": Linf [0, 100, 101] %, depth R</li> </ul>



	<p>10 "phase": Linf [0, 180, 181] phase  11 "spd": Logf [.05, 5, 201] Hz, speed  12 "feed": Linf [-90, 90, 181] %, feed</p>
	<p>Stereo Delay</p> <p>0 "mdl": ST-DL  1 "time": Linf [1, 3000, 3000] ms, time  2 "mode": str [ST, X, M] mode  3 "fact": str [1/4, 1/3, 1/2, 2/3, 3/4, 1, 3/8, 5/4, 4/3, 3/2, 2] factor  4 "pat": str [1/2:1, 2/3:1, 3/4:1, 7/8:1, 1:1, 1:9/8, 1:5/4, 1:4/3, 1:3/2] pattern  5 "offset": int [-50..50] ms, offset  6 "feed": Linf [0, 100, 101] %, feed  7 "flc": Logf [20, 400, 51] Hz, feed L cut  8 "fhc": Logf [200, 20000, 51] Hz, feed H cut  9 "lc": Logf [20, 400, 51] Hz, Low cut  10 "hc": Logf [200, 20000, 51] Hz, high cut</p>
	<p>UltraTap Delay</p> <p>0 "mdl": TAP-DL  1 "time": Linf [1, 2000, 2000] ms, time  2 "rep": int [1..16] repeat  3 "slp": Linf [-6, 6, 121] dB, slope  4 "fact": str [1/3, 1/2, 2/3, 3/4, 1, 5/4, 4/3, 3/2, 2] factor  5 "pdel": Linf [0, 500, 501] ms, pre delay  6 "mode": str [MOVE, JUMP, FOCUS, SPREAD] mode  7 "wid": Linf [-100, 100, 201] %, width  8 "diff": Linf [0, 100, 101] diffusion  9 "lc": Logf [20, 400, 51] Hz, Low cut  10 "hc": Logf [200, 20000, 51] Hz, high cut</p>
	<p>Tape Delay</p> <p>0 "mdl": TAPE-DL  1 "time": Linf [60, 650, 591] ms, time  2 "sust": Linf [0, 100, 101] %, sustain  3 "drv": Linf [0, 100, 101] %, drive  4 "wf": Linf [0, 100, 101] %, flutter</p>
	<p>OilCan Delay</p> <p>0 "mdl": OILCAN  1 "time": Linf [0, 10, 1001] time  2 "sust": Linf [0, 10, 101] %, sustain  3 "wb": Linf [0, 10, 101] %, wobble  4 "tone": Linf [0, 10, 101] %, tone</p>
	<p>BBD Delay</p> <p>0 "mdl": BBD-DL  1 "dLy": Linf [0, 100, 1001] time  2 "feed": Linf [0, 100, 101] %, feed</p>
	<p>Stereo Pitch</p> <p>0 "mdl": PITCH  1 "semi": int [-12..12] semitones  2 "cent": int [-50..50] cent  3 "dLy": Linf [0, 500, 501] ms, delay  4 "lc": Logf [20, 400, 51] Hz, Low cut  5 "hc": Logf [200, 20000, 51] Hz, high cut  6 "mix": Linf [0, 100, 101] %, mix</p>



## Dual Pitch



```



0 "mdl": D-PITCH
1 "semi1": int [-12..12] semitones 1
2 "cent1": int [-50..50] cent 1
3 "dly1": linf [0, 500, 501] ms, delay 1
4 "pan1": linf [-100, 100, 201] %, pan 1
5 "lvl1": fader lvl 1 dB
6 "semi2": int [-12..12] semitones 2
7 "cent2": int [-50..50] cent 2
8 "dly2": linf [0, 500, 501] ms, delay 2
9 "pan2": linf [-100, 100, 201] %, pan 2
10 "lvl2": fader lvl 2 dB
11 "lc": logf [20, 400, 51] Hz, Low cut
12 "hc": logf [200, 20000, 51] Hz, high cut

```



## Channel effects

	<p>None</p> <p>0 "mdl": NONE</p>
	<p>External</p> <p>0 "mdl": EXT</p> <p>1 "egrp": str [OFF, LCL, AUX, A, B, C, SC, USB, CRD, MOD, PLAY, AES] ext grp</p> <p>2 "ein": int [1..64] ext in</p> <p>3 "emode": str [M, ST, M/S] ext mode</p> <p>4 "lat": int [0..200] latency</p> <p>5 "trim": linf [-18, 18, 361] dB, trim</p>
	<p>Soul Analog EQ</p> <p>0 "mdl": SOUL</p> <p>1 "mix": linf [0, 125, 126] %, mix</p> <p>2 "Lf": linf [0, 10, 101] lo freq</p> <p>3 "Lg": linf [-5, 5, 101] lo gain</p> <p>4 "Lmf": linf [0, 10, 101] lm freq</p> <p>5 "Lmf3": int [0, 1] lm /3</p> <p>6 "Lmq": linf [0, 10, 101] lm q</p> <p>7 "Lmg": linf [-5, 5, 101] lm gain</p> <p>8 "hmf": linf [0, 10, 101] hm freq</p> <p>9 "hmf3": int [0, 1] hm x3</p> <p>10 "hmq": linf [0, 10, 101] hm q</p> <p>11 "hmg": linf [-5, 5, 101] hm gain</p> <p>12 "hf": linf [0, 10, 101] hf freq</p> <p>13 "hg": linf [-5, 5, 101] hf gain</p>
	<p>Even 88-Formant EQ</p> <p>0 "mdl": E88</p> <p>1 "mix": linf [0, 125, 126] %, mix</p> <p>2 "Lf": linf [0, 10, 101] lf freq</p> <p>3 "Lg": linf [-5, 5, 101] lf gain</p> <p>4 "Lq": str [LOW, HIGH] lf q</p> <p>5 "Lt": str [BELL, SHELV] lf type</p> <p>6 "Lmf": linf [0, 10, 101] lm freq</p> <p>7 "Lmg": linf [-5, 5, 101] lm gain</p> <p>8 "Lmq": linf [0, 10, 101] lm q</p> <p>9 "hmf": linf [0, 10, 101] hm freq</p> <p>10 "hmq": linf [-5, 5, 101] hm gain</p> <p>11 "hmg": linf [0, 10, 101] hm q</p> <p>12 "hfg": linf [0, 10, 101] hf freq</p> <p>13 "hg": linf [-5, 5, 101] hf gain</p> <p>14 "hq": str [LOW, HIG] hf q</p> <p>15 "ht": str [BELL, SHELV] hf type</p>
	<p>Even 84 EQ</p> <p>0 "mdl": E84</p> <p>1 "mix": linf [0, 125, 126] %, mix</p> <p>2 "g": linf [-20, 20, 81] dB, gain</p> <p>3 "Lf": str [OFF, 35, 60, 110, 220] lf freq</p> <p>4 "Lg": linf [-5, 5, 101] lf gain</p> <p>5 "mf": str [OFF, 350, 700, 1k6, 3k2, 4k8, 7k2] mid freq</p> <p>6 "mg": linf [-5, 5, 101] mid gain</p> <p>7 "mq": str [LOW, HIGH] mid q</p> <p>8 "hfg": str [10k, 12k, 16k, OFF] hf freq</p> <p>9 "hg": linf [-5, 5, 101] hf gain</p>
	<p>Focusrite ISA 110 EQ</p> <p>0 "mdl": F110</p> <p>1 "mix": linf [0, 125, 126] %, mix</p> <p>2 "peq": int [0, 1] peq on</p> <p>3 "Lmf": linf [0, 10, 101] lm freq</p> <p>4 "Lmq": linf [-5, 5, 101] lm gain</p> <p>5 "Lmq": linf [0, 10, 101] lm q</p>

	<pre> 6 "lmf3": int [0, 1] lm /3 7 "hmf":  Linf [0, 10, 101] hm freq 8 "hmg":  Linf [-5, 5, 101] hm gain 9 "hmq":  Linf [0, 10, 101] hm q 10 "hmf3": int [0, 1] hm x3 11 "shv":  inf [0, 1] shv on 12 "lf":   str [33, 56, 95, 160,             270, 460] lf freq 13 "lg":   Linf [-5, 5, 101] lf gain 14 "hf":   str [3k3, 4k7, 6k8, 10k,             15k, 18k] hf freq 15 "hg":   Linf [-5, 5, 101] hf q 16 "g":    Linf [-18, 18, 73] gain </pre>
	<p>Pulsar P1a/M5 EQ</p> <pre> 0 "mdl":  PULSAR 1 "mix":  Linf [0, 125, 126] %, mix 2 "eq1":  int [0, 1] eq1 on 3 "1lb":  Linf [0, 10, 101] lf boost 4 "1latt": Linf [0, 10, 101] lf att 5 "1lf":  str [20, 30, 60, 100] Hz, lf freq 6 "1hw":  Linf [0, 10, 101] hf wid 7 "1hb":  Linf [0, 10, 101] hf boost 8 "1hf":  str [3k, 4k, , 5k, 8k, 10k,             12k, 16k] Hz, hf freq 9 "1hatt": Linf [0, 10, 101] hf att 10 "1hattf":str [5k, 10k, 20k] hf att 11 "eq5":  int [0, 1] eq5 on 12 "5lb":  Linf [0, 10, 101] lm boost 13 "5lf":  str [200, 300, 500, 700,             1k] Hz, lf freq 14 "5md":  Linf [0, 10, 101] mid dip 15 "5mf":  str [200, 300, 500, 700, 1k, 1k5,             2k, 3k, 4k, 5k, 7k] Hz, mid freq 16 "5hb":  Linf [0, 10, 101] HM boost 17 "5hf":  str [1k5, 2k, 3k, 4k,             5k] Hz, hf freq </pre>
	<p>Mach EQ4</p> <pre> 0 "mdl":  MACH4 1 "mix":  Linf [0, 125, 126] %, mix 2 "sub":  Linf [-5, 5, 101] sub 3 "40":   Linf [-5, 5, 101] 40 4 "160":  Linf [-5, 5, 101] 160 5 "650":  Linf [-5, 5, 101] 650 6 "2k5":  Linf [-5, 5, 101] 2k5 7 "air":  Linf [0, 10, 101] air 8 "airm": str [OFF, 2k5, 5k, 10k,             20k, 40k] air mode 9 "again": int [0, 1] auto </pre>
	<p>Even Channel</p> <p>Even 88 Gate, Even 88 Formant EQ, Even Compressor/Limiter</p> <pre> 0 "mdl":  *EVEN* 1 "g_thr": Linf [-40.0, 0.0, 81] dB 2 "g_hyst": Linf [0.0, 25.0, 51] dB 3 "g_range": Linf [0, 60, 61] dB 4 "g_rel":  Logf [100, 3000, 130] ms 5 "g_fast": int [0, 1] 6 "g_m40": int [0, 1] 7 "g_on":   int [0, 1] 8 "eq_on":  int [0, 1] 9 "Lf":    Linf [0.0, 10.0, 101] 10 "Lg":   Linf [-5.0, 5.0, 101] 11 "Lq":   Str [LOW, HIGH] 12 "Lt":   Str [BELL, SHELV] 13 "Lmf":  Linf [0.0, 10.0, 101] 14 "Lmg":  Linf [-5.0, 5.0, 101] 15 "Lmq":  Linf [0.0, 10.0, 101] 16 "hmf":  Linf [0.0, 10.0, 101] </pre>

	<pre> 17 "hmg": Linf [-5.0, 5.0, 101] 18 "hmq": Linf [0.0, 10.0, 101] 19 "hf": Linf [0.0, 10.0, 101] 20 "hg": Linf [-5.0, 5.0, 101] 21 "hq": Str [LOW, HIGH] 22 "ht": Str [BELL, SHELV] 23 "mix": Linf [0, 125 %, 126] 24 "d_lon": int [0, 1] 25 "d_lthr": Linf [-12.0, 0.0, 25] dB 26 "d_lrec": Str [50, 100, 200, 800, A1, A2] 27 "d_lfast": int [0, 1] 28 "d_con": int [0, 1] 29 "d_cthr": Linf [-35.0, -5.0 dB, 61] 30 "d_ratio": Str [1.5, 2.0, 3.0, 4.0, 6.0] 31 "d_crec": Str [100, 400, 800, 1500, A1, A2] 32 "d_cfast": int [0, 1] 33 "d_gain": Linf [-6, 12 dB, 7] </pre>
	<p>Soul Channel Soul 9000 Gate/Expander, Soul AnaLogue EQ, Soul 9000 Channel Compressor</p> <pre> 0 "mdl": *SOUL* 1 "g_thr": Linf [-40.0, 0.0, 81] dB 2 "g_range": Linf [0, 40, 41] dB 3 "g_hld": Logf [10, 4000, 130] ms 4 "g_rel": Logf [100, 4000, 130] ms 5 "g_fast": int [0, 1] 6 "g_mode": Str [GATE, EXP] 7 "g_on": int [0, 1] 8 "eq_on": int [0, 1] 9 "lf": Linf [0.0, 10.0, 101] 10 "lg": Linf [-5.0, 5.0, 101] 11 "lmf": Linf [0.0, 10.0, 101] 12 "lmf3": int [0, 1] 13 "lmq": Linf [0.0, 10.0, 101] 14 "lmg": Linf [-5.0, 5.0, 101] 15 "hmf": Linf [0.0, 10.0, 101] 16 "hmf3": int [0, 1] 17 "hmq": Linf [0.0, 10.0, 101] 18 "hmg": Linf [-5.0, 5.0, 101] 19 "hf": Linf [0.0, 10.0, 101] 20 "hg": Linf [-5.0, 5.0, 101] 21 "mix": Linf [0, 125 %, 126] 22 "d_on": int [0, 1] 23 "d_thr": Linf [-30.0, 18.0, 97] dB 24 "d_ratio": Str [1.3, 1.4, 1.6, 1.8, 2.0,                 2.5, 2.8, 3.3, 4.0, 5.0,                 6.0, 7.0, 9.0, 12, 20,                 50, 100] 25 "d_fast": int [0, 1] 26 "d_rel": Logf [100, 4000, 65] ms 27 "d_peak": int [0, 1] </pre>
	<p>Vintage Channel 76 Limiting Amplifier, Pulsar EQ P1A/m5, Model 2A Leveling Amplifier</p> <pre> 0 "mdl": *VINTAGE* 1 "d_in": Linf [-48.0, 0.0, 97] dB 2 "d_out": Linf [-48.0, 0.0, 97] dB 3 "d_att": Linf [1.0, 7.0, 61] 4 "d_rel": Linf [1.0, 7.0, 61] 5 "d_ratio": Str [4, 8, 12, 20, ALL] 6 "d_on": int [0, 1] 7 "eq1": int [0, 1] 8 "1lb": Linf [0.0, 10.0, 101] 9 "1latt": Linf [0.0, 10.0, 101] 10 "1lf": Str [20, 30, 60, 100] 11 "1hw": Linf [0.0, 10.0, 101] 12 "1hb": Linf [0.0, 10.0, 101] 13 "1hf": Str [3k, 4k, 5k, 8k, 10k, 12k, 16k] 14 "1hatt": Linf [0.0, 10.0, 101] 15 "1hattf": Str [5k, 10k, 20k] </pre>



	<pre> 16 "eq5":      int [0, 1] 17 "5Lb":     Linf [0.0, 10.0, 101] 18 "5Lf":     Str [200, 300, 500, 700, 1k] 19 "5md":     Linf [0.0, 10.0, 101] 20 "5mf":     Str [200, 300, 500, 700, 1k, 1k5,                 2k, 3k, 4k, 5k, 7k] 21 "5hb":     Linf [0.0, 10.0, 101] 22 "5hf":     Str [1k5, 2k, 3k, 4k, 5k] 23 "L_ingain": Linf [0, 100, 101] 24 "L_peak":  Linf [0, 100, 101] 25 "L_mode":  Str [COMP, LIM] 26 "L_on":    int [0, 1] </pre>
	<p>Bus Channel</p> <p>Soul Warmth, Even 84 EQ, Soul G Bus Compressor</p> <pre> 0 "mdl":      *BUS* 1 "w_drv":    Linf [10, 125, 116] % 2 "w_hrm":    Linf [-100, 100, 201] 3 "w_col":    Linf [-1.00, +1.00, 41] 4 "w_trim":   Linf [-18.0, +6.0, 49] dB 5 "w_mix":    Linf [0, 100, 101] % 6 "w_on":     int [0, 1] 7 "eq_on":    int [0, 1] 9 "g":        Linf [-20.0, 20.0, 81] dB 10 "Lf":      Str [OFF, 35, 60, 110, 220] 11 "Lg":      Linf [-5.0, 5.0, 101] 12 "mf":      Str [OFF, 350, 700, 1k6, 3k2,                 4k8, 7k2] 13 "mg":      Linf [-5.0, 5.0, 101] 14 "mq":      Str [LOW, HIGH] 15 "hf":      Str [10k, 12k, 16k, OFF] 16 "hg":      Linf [-5.0, 5.0, 101] 17 "mix":     Linf [0, 125 %, 126] 18 "d_thr":   Linf [-40.0, 0.0, 81] dB 19 "d_ratio": Str [1.5, 2.0, 3.0, 4.0, 5.0, 10] 20 "d_att":   Str [0.1, 0.3, 1.0, 3.0, 10.0, 30.0] 21 "d_rel":   Str [0.1, 0.2, 0.4, 0.8, 1.6, AUTO] 22 "d_gain":  Linf [-6.0, 12.0, 37] dB 23 "d_on":    int [0, 1] </pre>
	<p>Mastering</p> <p>Tape, Mach EQ4 EQ, Stereo Enhancer, Precision Limiter</p> <pre> 0 "mdl":      *MASTER* 1 "t_drv":    Linf [-5.0, 25.0, 61] dB 2 "t_spd":    Logf [7.5, 30.0, 65] 3 "t_Low":    int [0, 1] 4 "t_hi":     int [0, 1] 5 "t_on":     int [0, 1] 6 "sub":      Linf [-5.0, 5.0, 201] 7 "40":       Linf [-5.0, 5.0, 201] 8 "160":      Linf [-5.0, 5.0, 201] 9 "650":      Linf [-5.0, 5.0, 201] 10 "2k5":     Linf [-5.0, 5.0, 201] 11 "air":     Linf [0.0, 10.0, 201] 12 "airm":    Str [OFF, 2k5, 5k, 10k, 20k, 40k] 13 "eq_on":   int [0, 1] 14 "e_stLvl": Linf [-100, +100, 201] % 15 "e_Lmf":   Linf [-100, +100, 201] % 16 "e_mLvl":  Linf [-100, +100, 201] % 17 "e_st":    Linf [-100, 100, 201] % 18 "e_m":     Linf [-100, 100, 201] % 19 "e_bass":  Linf [0, 100, 101] % 20 "e_mid":   Linf [0, 100, 101] % 21 "e_high":  Linf [0, 100, 101] % 22 "e_bassf": Linf [1, 50, 50] 23 "e_midq":  Linf [1, 50, 50] 24 "e_highf": Linf [1, 50, 50] 25 "e_on":    int [0, 1] 26 "L_gin":   Linf [0.00, 18.00, 73] dB 27 "L_gout":  Linf [-18.00, 0.00, 73] dB 28 "L_sqz":   int [0, 100] </pre>

29	" <i>L_knee</i> ":	int [0, 10]
30	" <i>L_gain</i> ":	int [0, 1]
31	" <i>L_att</i> ":	Linf [0.05, 1.00, 96] ms
32	" <i>L_rel</i> ":	Logf [20, 2000, 101] ms
33	" <i>L_on</i> ":	int [0, 1]







# Plugins

## Filter plugins

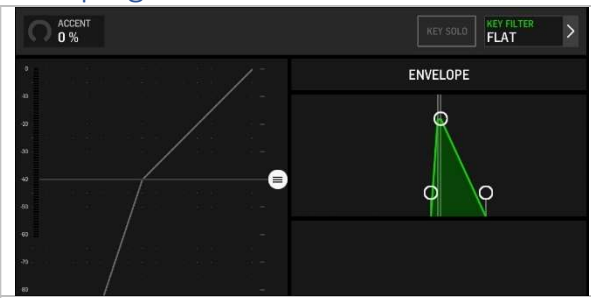
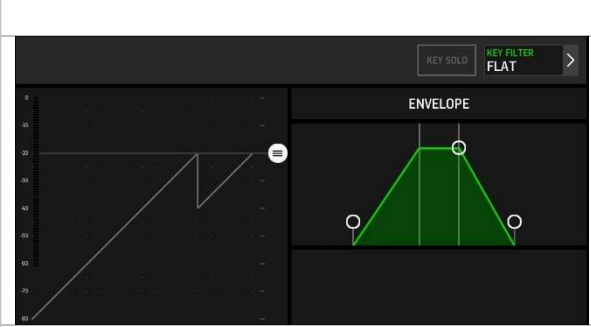
	<p>Tilt Filter</p> <pre>0 "mdl": TILT 1 "tilt": Linf [-6, 6, 49] tilt</pre>
	<p>Maxer Filter</p> <pre>0 "mdl": MAX 1 "Low": Linf [0, 100, 101] %, low cont 2 "proc": Linf [0, 100, 101] %, high proc</pre>
	<p>AP90 Filter (all pass)</p> <pre>0 "mdl": AP1 1 "freq": Logf [100, 10000, 100] Hz, freq</pre>
	<p>AP180 Filter (all pass)</p> <pre>0 "mdl": AP2 1 "f": Logf [100, 10000, 100] Hz, freq 2 "q": Logf [.442, 10, 181] q</pre>



# Gate plugins

	<p>Standard Gate/Expander</p> <ul style="list-style-type: none"> <li>0 "mdl": GATE</li> <li>1 "thr": Linf [-80, 0, 161] dB, thr</li> <li>2 "range": Linf [3, 60, 115] dB, range</li> <li>3 "att": Linf [0, 120, 121] ms, attack</li> <li>4 "hold": Linf [1, 200, 200] ms, hold</li> <li>5 "rel": Logf [4, 4000, 130] ms, release</li> <li>6 "acc": Linf [0, 100, 21] %, accent</li> <li>7 "ratio": str [1:1.5, 1:2, 1:3, 1:4, gate] ratio</li> </ul>
	<p>Standard Ducker</p> <ul style="list-style-type: none"> <li>0 "mdl": DUCK</li> <li>1 "thr": Linf [-80, 0, 161] dB, thr</li> <li>2 "range": Linf [3, 60, 115] dB, range</li> <li>3 "att": Linf [0, 120, 121] ms, attack</li> <li>4 "hold": Linf [1, 200, 200] ms, hold</li> <li>5 "rel": Linf [20, 4000, 130] ms, release</li> </ul>
	<p>SSL 9000 Gate/Expander</p> <ul style="list-style-type: none"> <li>0 "mdl": 9000G</li> <li>1 "thr": Linf [-40, 0, 81] dB, input</li> <li>2 "range": Linf [-0, 40, 41] dB</li> <li>3 "hld": Logf [10, 4000, 130] ms, hold</li> <li>4 "rel": Logf [100, 4000, 130] ms, release</li> <li>5 "fast": int [0, 1] fast</li> <li>6 "mode": str [GATE, EXP] mode</li> </ul>
	<p>Even 88-Gate</p> <ul style="list-style-type: none"> <li>0 "mdl": E88</li> <li>1 "thr": Linf [-40, 0, 81] dB, thr</li> <li>2 "hyst": Linf [0, 25, 51] dB, hyst</li> <li>3 "range": Linf [0, 60, 61] dB, range</li> <li>4 "rel": Logf [100, 3000, 130] ms, release</li> <li>5 "fast": int [0, 1] fast</li> <li>6 "m40": int [0, 1] thr</li> </ul>
	<p>DrawMore Expander Gate 241</p> <ul style="list-style-type: none"> <li>0 "mdl": DUCK</li> <li>1 "thr": Linf [-80, 0, 161] dB, thr</li> <li>2 "slow": int [0, 1] slow</li> </ul>
	<p>DBX 902 De-Esser</p> <ul style="list-style-type: none"> <li>0 "mdl": DS902</li> <li>1 "f": Logf [800, 8000, 130] Hz, freq</li> <li>2 "range": Linf [3, 12, 25] dB, range</li> <li>3 "mode": str [FULL, HF] mode</li> </ul>
	<p>76 Limiting Amp</p> <ul style="list-style-type: none"> <li>0 "mdl": 76LA</li> <li>1 "in": Linf [-48, 0, 97] dB, input</li> <li>2 "out": Linf [-48, 0, 97] dB</li> <li>3 "att": Linf [1, 7, 61] attack</li> <li>4 "rel": Linf [1, 7, 61] release</li> <li>5 "ratio": str [4, 8, 12, 20, ALL] ratio</li> </ul>

	<p>Leveling Amplifier 2A</p> <ul style="list-style-type: none"> <li>0 "mdl": LA</li> <li>1 "ingain": <i>linf</i> [0, 100, 101] gain</li> <li>2 "peak": <i>linf</i> [0, 100, 101] peak</li> <li>3 "mode": <i>str</i> [comp, lim] mode</li> </ul>
	<p>Source Extractor</p> <ul style="list-style-type: none"> <li>0 "mdl": PSE</li> <li>1 "thr": <i>linf</i> [-36, 12, 97] dB, threshold</li> <li>2 "depth": <i>linf</i> [0, 20, 41] dB, depth</li> <li>3 "fast": <i>int</i> [0, 1] fast</li> <li>4 "peak": <i>int</i> [0, 1] peak</li> </ul>
	<p>PSE/LA Combo</p> <ul style="list-style-type: none"> <li>0 "mdl": CMB</li> <li>1 "thr": <i>linf</i> [-36, 12, 97] dB, threshold</li> <li>2 "depth": <i>linf</i> [0, 20, 41] dB, depth</li> <li>3 "fast": <i>int</i> [0, 1] fast</li> <li>4 "peak": <i>int</i> [0, 1] peak</li> <li>5 "ingain": <i>linf</i> [0, 100, 101] gain</li> <li>6 "peak": <i>linf</i> [0, 100, 101] peak</li> <li>7 "mode": <i>str</i> [comp, lim] mode</li> </ul>
	<p>Wave Designer</p> <ul style="list-style-type: none"> <li>0 "mdl": WAVE</li> <li>1 "att": <i>linf</i> [-15, 15, 61] dB, attack</li> <li>2 "sust": <i>linf</i> [-24, 24, 97] dB, sustain</li> <li>3 "g": <i>linf</i> [-18, 9, 55] dB, gain</li> </ul>
	<p>Auto Rider Dynamics</p> <ul style="list-style-type: none"> <li>0 "mdl": RIDE</li> <li>1 "thr": <i>linf</i> [-54, 18, 73] dB, thr</li> <li>2 "tgt": <i>linf</i> [-48, 0, 97] dB, target</li> <li>3 "spd": <i>int</i> [1..50] speed</li> <li>4 "ratio": <i>flt</i> [2.0, 4.0, 8.0, 20.0, 100.0] ratio</li> <li>5 "hld": <i>logf</i> [.1, 10, 65] s, hold</li> <li>6 "range": <i>linf</i> [1, 15, 29] dB, range</li> </ul>
	<p>Soul Warmth Preamp</p> <ul style="list-style-type: none"> <li>0 "mdl": WARM</li> <li>1 "drv": <i>linf</i> [10, 100, 91] %, drive</li> <li>2 "hrm": <i>linf</i> [-100, 100, 201] harm</li> <li>3 "col": <i>linf</i> [-1, 1, 41] color</li> <li>3 "trim": <i>linf</i> [-18, 6, 49] dB, trim</li> <li>4 "mix": <i>linf</i> [0, 100, 101] dB, mix</li> </ul>
	<p>Dynamic EQ</p> <ul style="list-style-type: none"> <li>0 "mdl": DEQ</li> <li>1 "thr": <i>linf</i> [-60, 0, 121] dB, thr</li> <li>2 "ratio": <i>flt</i> [1.2, 1.3, 1.5, 2.0, 3.0, 5.0, 10.0] ratio</li> <li>3 "att": <i>linf</i> [0, 200, 201] ms, attack</li> <li>4 "rel": <i>logf</i> [20, 4000, 130] ms, release</li> <li>5 "filt": <i>str</i> [OFF, BP, LP6, LP12, HP6, HP12] filter</li> <li>6 "g": <i>linf</i> [-15, 15, 301] dB, gain</li> <li>7 "f": <i>logf</i> [20, 20000, 961] Hz, freq</li> <li>8 "q": <i>logf</i> [.442, 10, 181] q</li> <li>9 "mode": <i>str</i> [Low, high] mode</li> </ul>

## EQ plugins

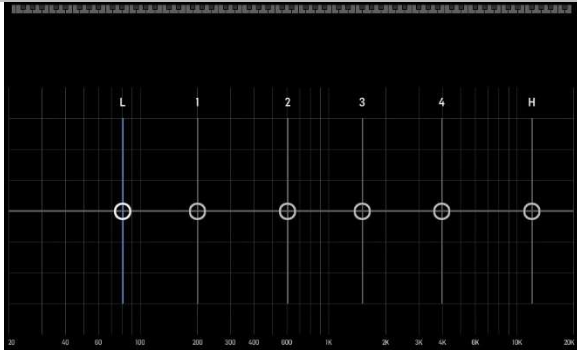

### Standard EQ

Channel:

```

0 "mdl": STD
1 "lg":   linf [-15, 15, 301] dB, gain l
2 "lf":   logf [20, 20000, 961] Hz, freq l
3 "lq":   logf [0.442, 10, 181] q l
4 "leq":  str [SHV, PEQ] eq l
5 "1g":   linf [-15, 15, 301] dB, gain 1
6 "1f":   logf [20, 20000, 961] Hz, freq 1
7 "1q":   logf [0.442, 10, 181] q 1
8 "2g":   linf [-15, 15, 301] dB, gain 2
9 "2f":   logf [20, 20000, 961] Hz, freq 2
10 "2q":  logf [0.442, 10, 181] q 2
11 "3g":  linf [-15, 15, 301] dB, gain 3
12 "3f":  logf [20, 20000, 961] Hz, freq 3
13 "3q":  logf [0.442, 10, 181] q 3
14 "4g":  linf [-15, 15, 301] dB, gain 4
15 "4f":  logf [20, 20000, 961] Hz, freq 4
16 "4q":  logf [0.442, 10, 181] q 4
17 "hg":  linf [-15, 15, 301] dB, gain h
18 "hf":  logf [50, 20000, 833] Hz, freq h
19 "hq":  logf [0.442, 10, 181] q h
20 "heq": str [SHV, PEQ] eq h
    
```

Bus, mtx, main:

```

0 "mdl": STD
1 "lg":   linf [-15, 15, 301] dB, gain l
2 "lf":   logf [20, 2000, 641] Hz, freq l
3 "lq":   logf [0.442, 10, 181] q l
4 "leq":  str [SHV, PEQ, CUT] eq l
5 "1g":   linf [-15, 15, 301] dB, gain 1
6 "1f":   logf [20, 20000, 961] Hz, freq 1
7 "1q":   logf [0.442, 10, 181] q 1
8 "2g":   linf [-15, 15, 301] dB, gain 2
9 "2f":   logf [20, 20000, 961] Hz, freq 2
10 "2q":  logf [0.442, 10, 181] q 2
11 "3g":  linf [-15, 15, 301] dB, gain 3
12 "3f":  logf [20, 20000, 961] Hz, freq 3
13 "3q":  logf [0.442, 10, 181] q 3
14 "4g":  linf [-15, 15, 301] dB, gain 4
15 "4f":  logf [20, 20000, 961] Hz, freq 4
16 "4q":  logf [0.442, 10, 181] q 4
17 "5g":  linf [-15, 15, 301] dB, gain 5
18 "5f":  logf [20, 20000, 961] Hz, freq 5
19 "5q":  logf [0.442, 10, 181] q 5
20 "6g":  linf [-15, 15, 301] dB, gain 6
21 "6f":  logf [20, 20000, 961] Hz, freq 6
22 "7q":  logf [0.442, 10, 181] q 6
23 "hg":  linf [-15, 15, 301] dB, gain h
24 "hf":  logf [50, 20000, 833] Hz, freq h
25 "hq":  logf [0.442, 10, 181] q h
26 "heq": str [SHV, PEQ, CUT] eq h
27 "tilt": linf [-6, 6, 49] dB, tilt
    
```



### Soul Analog EQ

```

0 "mdl": SOUL
1 "mix":  linf [0, 125, 126] %, mix
2 "lf":   linf [0, 10, 101] lo freq
3 "lg":   linf [-5, 5, 101] lo gain
4 "lmf":  linf [0, 10, 101] lm freq
5 "lmf3": int [0, 1] lm /3
6 "lmq":  linf [0, 10, 101] lm q
7 "lmg":  linf [-5, 5, 101] lm gain
8 "hmf":  linf [0, 10, 101] hm freq
9 "hmf3": int [0, 1] hm x3
10 "hmq": linf [0, 10, 101] hm q
11 "hmg": linf [-5, 5, 101] hm gain
12 "hf":  linf [0, 10, 101] hf freq
13 "hg":  linf [-5, 5, 101] hf gain
    
```

	<p>Even 88-Formant EQ</p> <pre> 0 "mdl": E88 1 "mix": linf [0, 125, 126] %, mix 2 "Lf": linf [0, 10, 101] Lf freq 3 "Lg": linf [-5, 5, 101] Lf gain 4 "Lq": str [LOW, HIGH] Lf q 5 "Lt": str [BELL, SHELV] Lf type 6 "Lmf": linf [0, 10, 101] Lm freq 7 "Lmg": linf [-5, 5, 101] Lm gain 8 "Lmq": linf [0, 10, 101] Lm q 9 "hmf": linf [0, 10, 101] hm freq 10 "hmg": linf [-5, 5, 101] hm gain 11 "hmq": linf [0, 10, 101] hm q 12 "hf": linf [0, 10, 101] hm freq 13 "hg": linf [-5, 5, 101] hf gain 14 "hq": str [LOW, HIG] hf q 15 "ht": str [BELL, SHELV] hf type </pre>
	<p>Even 84 EQ</p> <pre> 0 "mdl": E84 1 "mix": linf [0, 125, 126] %, mix 2 "g": linf [-20, 20, 81] dB, gain 3 "Lf": str [OFF, 35, 60, 110, 220] Lf freq 4 "Lg": linf [-5, 5, 101] Lf gain 5 "mf": str [OFF, 350, 700, 1k6, 3k2, 4k8, 7k2] mid freq 6 "mg": linf [-5, 5, 101] mid gain 7 "mq": str [LOW, HIGH] mid q 8 "hf": str [10k, 12k, 16k, OFF] hf freq 9 "hg": linf [-5, 5, 101] hf gain </pre>
	<p>Focusrite ISA 110 EQ</p> <pre> 0 "mdl": F110 1 "mix": linf [0, 125, 126] %, mix 2 "peq": int [0, 1] peq on 3 "Lmf": linf [0, 10, 101] Lm freq 4 "Lmg": linf [-5, 5, 101] Lm gain 5 "Lmq": linf [0, 10, 101] Lm q 6 "Lmf3": int [0, 1] Lm /3 7 "hmf": linf [0, 10, 101] hm freq 8 "hmg": linf [-5, 5, 101] hm gain 9 "hmq": linf [0, 10, 101] hm q 10 "hmf3": int [0, 1] hm x3 11 "shv": inf [0, 1] shv on 12 "Lf": str [33, 56, 95, 160, 270, 460] Lf freq 13 "Lg": linf [-5, 5, 101] Lf gain 14 "hf": str [3k3, 4k7, 6k8, 10k, 15k, 18k] hf freq 15 "hg": linf [-5, 5, 101] hf q 16 "g": linf [-18, 18, 73] gain </pre>
	<p>Pulsar P1a/M5 EQ</p> <pre> 0 "mdl": PULSAR 1 "mix": linf [0, 125, 126] %, mix 2 "eq1": int [0, 1] eq1 on 3 "1lb": linf [0, 10, 101] Lf boost 4 "1latt": linf [0, 10, 101] Lf att 5 "1Lf": str [20, 30, 60, 100] Hz, Lf freq 6 "1hw": linf [0, 10, 101] hf wid 7 "1hb": linf [0, 10, 101] hf boost 8 "1hf": str [3k, 4k, , 5k, 8k, 10k, 12k, 16k] Hz, hf freq 9 "1hatt": linf [0, 10, 101] hf att 10 "1hattf":str [5k, 10k, 20k] hf att 11 "eq5": int [0, 1] eq5 on 12 "5lb": linf [0, 10, 101] Lm boost 13 "5Lf": str [200, 300, 500, 700, </pre>

	<p>1k] Hz, lf freq</p> <p>14 "5md": linf [0, 10, 101] mid dip</p> <p>15 "5mf": str [200, 300, 500, 700, 1k, 1k5, 2k, 3k, 4k, 5k, 7k] Hz, mid freq</p> <p>16 "5hb": linf [0, 10, 101] HM boost</p> <p>17 "5hf": str [1k5, 2k, 3k, 4k, 5k] Hz, hf freq</p>
	<p>Mach EQ4</p> <p>0 "mdl": MACH4</p> <p>1 "mix": linf [0, 125, 126] %, mix</p> <p>2 "sub": linf [-5, 5, 101] sub</p> <p>3 "40": linf [-5, 5, 101] 40</p> <p>4 "160": linf [-5, 5, 101] 160</p> <p>5 "650": linf [-5, 5, 101] 650</p> <p>6 "2k5": linf [-5, 5, 101] 2k5</p> <p>7 "air": linf [0, 10, 101] air</p> <p>8 "airm": str [OFF, 2k5, 5k, 10k, 20k, 40k] air mode</p> <p>9 "again": int [0, 1] auto</p>



# Compressor plugins

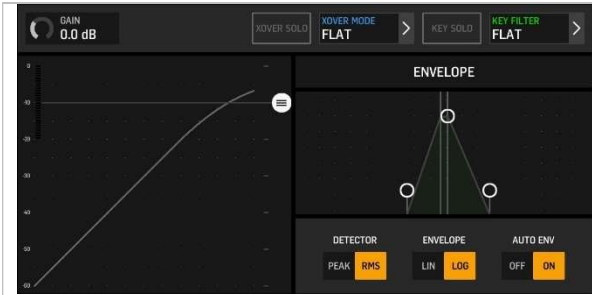

## Standard compressor

- 0 "mdl": COMP
- 1 "mix": linf [0, 100, 101] %, mix
- 2 "gain": linf [-6, 12, 37] dB, gain
- 3 "thr": linf [-60, 0, 121] dB, thr
- 4 "ratio": flt [1.1, 1.2, 1.3, 1.5, 1.7, 2.0, 2.5, 3.0, 3.5, 4.0, 5.0, 6.0, 8.0, 10., 20., 50., 100.] ratio
- 5 "knee": int [0..5] knee
- 6 "det": str [PEAK, RMS] detector
- 7 "att": linf [0, 120, 121] ms, attack
- 8 "hld": linf [1, 200, 200] ms, hold
- 9 "rel": logf [4, 4000, 130] ms release
- 10 "env": str [LIN, LOG] envelope
- 11 "auto": int [0, 1] auto

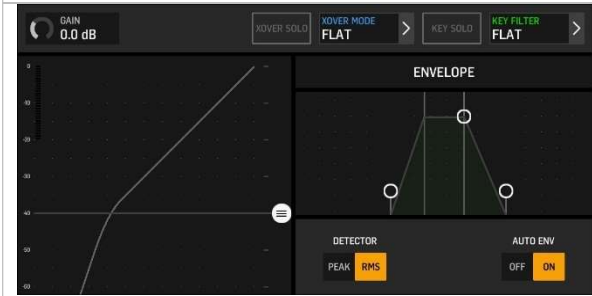

## Standard expander

- 0 "mdl": EXP
- 1 "mix": linf [0, 100, 101] %, mix
- 2 "gain": linf [-6, 12, 37] dB, gain
- 3 "thr": linf [-60, 0, 121] dB, thr
- 4 "ratio": flt [1.1, 1.2, 1.3, 1.5, 1.7, 2.0, 2.5, 3.0, 3.5, 4.0, 5.0, 6.0, 8.0, 10., 20., 50., 100.] ratio
- 5 "knee": int [0..5] knee
- 6 "det": str [PEAK, RMS] detector
- 7 "att": linf [0, 120, 121] ms, attack
- 8 "hld": linf [1, 200, 200] ms, hold
- 9 "rel": logf [4, 4000, 130] ms release
- 10 "env": str [LIN, LOG] envelope
- 11 "auto": int [0, 1] auto



## BDX 160 Compressor/Limiter

- 0 "mdl": B160
- 1 "mix": linf [0, 100, 101] %, mix
- 2 "gain": linf [-6, 12, 37] dB, gain
- 3 "thr": logf [0.01, 5, 65] thr
- 4 "ratio": flt [1.1, 1.2, 1.3, 1.5, 1.7, 2.0, 2.5, 3.0, 3.5, 4.0, 5.0, 6.0, 8.0, 10., 20., 50.] ratio



## BDX 560 Easy Compressor

- 0 "mdl": B560
- 1 "mix": linf [0, 100, 101] %, mix
- 2 "gain": linf [-6, 12, 37] dB, gain
- 3 "thr": linf [-40, 20, 121] dB, thr
- 4 "ratio": flt [1.1, 1.2, 1.5, 2.0, 3.0, 4.0, 5.0, 7.0, 10., 50., 999., -5.0, -3.0, -2.0, -1.0] ratio
- 5 "auto": int [0, 1] auto



## Draw More Compressor

- 0 "mdl": D241
- 1 "mix": linf [0, 100, 101] %, mix
- 2 "gain": linf [-6, 12, 37] dB, gain
- 3 "thr": linf [0, -60, 121] dB, thr
- 4 "ratio": flt [1.1, 1.2, 1.3, 1.5, 1.7, 2.0, 3.0, 3.5, 4.0, 5.0, 6.0, 8.0, 10.0, 20.0, 50.0, 100.0] ratio
- 5 "att": linf [1.5, 100, 65] ms, attack
- 6 "rel": logf [50, 5000, 130] ms release
- 7 "lim": linf [-20, 0, 41] dB, lim thr
- 8 "lrel": logf [50, 5000, 130] ms, lim rel
- 9 "auto": int [0, 1] auto



### Red Compressor

```

0 "mdl": RED3
1 "mix": linf [0, 100, 101] %, mix
2 "gain": linf [-6, 12, 37] dB, gain
3 "thr": linf [-48, 0, 97] dB, thr
4 "ratio": flt [1.1, 1.2, 1.3, 1.5, 2.0,
              2.5, 3.0, 3.5, 4.0, 5.0,
              6.0, 8.0, 10.] ratio
5 "att": linf [1, 50, 65] ms, attack
7 "rel": logf [100, 4000, 65] ms release
8 "auto": int [0, 1] auto

```



### Soul 9000 Channel Compressor

```

0 "mdl": 9000C
1 "mix": linf [0, 100, 101] %, mix
2 "gain": linf [-6, 12, 37] dB, gain
3 "thr": linf [-48, 0, 97] dB, thr
4 "ratio": flt [1.3, 1.43, 1.57, 1.8, 2.0,
              2.8, 3.3, 4.0, 5.0, 6.0,
              7.0, 9.0, 12.0, 20.0, 50.0,
              100.0] ratio
5 "fast": int [0, 1] fast att
6 "rel": logf [100, 4000, 65] ms release
7 "peak": int [0, 1] peak

```



### Soul G Bus Compressor

```

0 "mdl": SBUS
1 "mix": linf [0, 100, 101] %, mix
2 "gain": linf [-6, 12, 37] dB, gain
3 "thr": linf [-48, 0, 81] dB, thr
4 "ratio": flt [1.5, 2.0, 3.0, 4.0, 5.0,
              10.0] ratio
5 "att": flt [0.1, 0.3, 1.0, 3.0, 10.0,
              30.0] ratio
6 "rel": str [0.1, 0.2, 0.4, 0.8, 1.6,
              AUTO] release

```



### Even Compressor/Limiter

```

0 "mdl": ECL33
1 "mix": linf [0, 100, 101] %, mix
2 "gain": linf [-6, 12, 37] dB, gain
3 "lon": int [0, 1] lim on
4 "lthr": linf [-12, 0, 25] dB, lim thr
5 "lrec": str [50, 100, 200, 800,
              A1, A2] lim rec
6 "lfast": int [0, 1] lim fast
7 "con": int [0, 1] comp on
8 "cthr": linf [-35, -5, 61] dB, comp thr
9 "ratio": str [1.5, 2.0, 3.0, 4.0, 6.0] ratio
10 "crec": str [100, 400, 800, 1500,
               A1, A2] comp rec
11 "cfast": int [0, 1] comp fast

```



### Eternal Bliss

```

0 "mdl": BLISS
1 "mix": linf [0, 100, 101] %, mix
2 "gain": linf [-6, 12, 37] dB, gain
3 "thr": linf [-50, 0, 101] dB, thr
4 "ratio": flt [1.2, 1.3, 1.6, 2.0, 3.0,
              -1.0, -2.0, -3.0, -4.0] ratio
5 "att": linf [1.4, 150, 65] ms, attack
6 "rel": logf [5, 1200, 65] ms release
7 "afast": int [0, 1] auto fast
8 "alog": int [0, 1] anti log
9 "glon": int [0, 1] gr limit on
10 "glim": linf [-21, 0, 43] gr limit

```

	<p>Amplifier76 Limiting Amplifier</p> <pre> 0 "mdl": 76LA 1 "mix": linf [0, 100, 101] %, mix 2 "gain": linf [-6, 12, 37] dB, gain 3 "in": linf [-48, 0, 97] dB, input 4 "out": linf [-48, 0, 97] dB 5 "att": linf [1, 7, 61] attack 6 "rel": linf [1, 7, 61] release 7 "ratio": str [4, 8, 12, 20, ALL] ratio </pre>
	<p>Leveling Amplifier 2A</p> <pre> 0 "mdl": LA 1 "mix": linf [0, 100, 101] %, mix 2 "gain": linf [-6, 12, 37] dB, gain 3 "ingain": linf [0, 100, 101] gain 4 "peak": linf [0, 100, 101] peak 5 "mode": str [comp, lim] mode </pre>
	<p>PSE/LA Combo</p> <pre> 0 "mdl": CMB 1 "thr": linf [-36, 12, 97] dB, threshold 2 "depth": linf [0, 20, 41] dB, depth 3 "fast": int [0, 1] fast 4 "peak": int [0, 1] peak 5 "ingain": linf [0, 100, 101] gain 6 "peak": linf [0, 100, 101] peak 7 "mode": str [comp, lim] mode </pre>
	<p>Fairkid Model 670</p> <pre> 0 "mdl": F670 1 "mix": linf [0, 100, 101] %, mix 2 "gain": linf [-6, 12, 37] dB, gain 3 "in": linf [-20, 0, 81] dB, input 4 "thr": linf [0, 10, 41] thr 5 "time": int [1..6] time 6 "bias": linf [0, 1, 101] bias </pre>
	<p>No Stressor</p> <pre> 0 "mdl": NSTR 1 "mix": linf [0, 100, 101] %, mix 2 "gain": linf [-6, 12, 37] dB, gain 3 "in": linf [0, 10, 101] input 4 "ou": linf [0, 10, 101] output 5 "att": linf [0, 10, 101] attack 6 "rel": linf [0, 10, 101] release 7 "ratio": str [1.5:1, 2:1, 3:1, 4:1, 6:1, 10:1, 20:1, NUKE] ratio </pre>
	<p>PIA 2250</p> <pre> 0 "mdl": 2250 1 "mix": linf [0, 100, 101] %, mix 2 "gain": linf [-6, 12, 37] dB, gain 3 "thr": linf [0, 10, 101] threshold 4 "ratio": linf [0, 10, 101] output 5 "att": str [FAST, MED, SLOW] attack 6 "rel": logf [50, 3000, 130] ms, release 7 "knee": str [HARD, SOFT] knee 8 "Type": str [OLD, NEW] type </pre>
	<p>LTA100 Leveler</p> <pre> 0 "mdl": L100 1 "mix": linf [0, 100, 101] %, mix 2 "gain": linf [-6, 12, 37] dB, gain 3 "ingain": linf [0, 10, 101] gain 4 "gr": linf [0, 10, 101] gain reduction 5 "att": str [FAST, MED, SLOW] attack 6 "rel": str [FAST, MED, SLOW] release </pre>

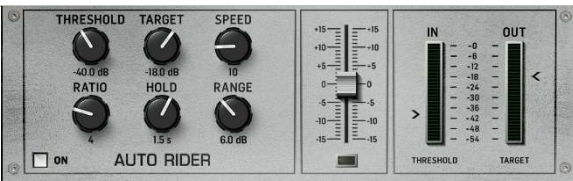

	<p>Wave Designer</p> <pre> 0 "mdl": WAVE 1 "mix": linf [0, 100, 101] %, mix 2 "gain": linf [-6, 12, 37] dB, gain 3 "att": linf [-15, 15, 61] dB, attack 4 "sust": linf [-24, 24, 97] dB, sustain 5 "g": linf [-16, 9, 55] dB, gain </pre>
	<p>Auto Rider Dynamics</p> <pre> 0 "mdl": RIDE 1 "mix": linf [0, 100, 101] %, mix 2 "gain": linf [-6, 12, 37] dB, gain 3 "thr": linf [-54, 18, 73] dB, thr 4 "tgt": linf [-48, 0, 97] dB, target 5 "spd": int [1..50] speed 6 "ratio": flt [2.0, 4.0, 8.0, 20.0, 100.0] ratio 7 "hld": logf [.1, 10, 65] s, hold 8 "range": linf [1, 15, 29] dB, range </pre>

## Appendix: Routing

Routing is a key aspect in digital consoles and can be ... intimidating, especially with desks such as WING, with a multitude of physical sources and destination, tap points, and total flexibility of signal path arrangements for mixing and routing. *“In the world of digital consoles with a multitude of inputs, outputs, and complex mixing capabilities, routing is the fundamental process that determines how audio signals flow throughout the system. It's akin to a sophisticated traffic control center, ensuring each sound reaches its intended destination with the desired processing applied. Routing in digital consoles is the foundation for achieving a high-quality, well-controlled sound. By mastering this skill, you can unlock the full potential of your console and create professional-sounding mixes with unparalleled flexibility”<sup>97</sup>.*

The following chapters along with existing videos on routing you can find on the web will help you with your first steps in routing your signals in the WING console.

WING routing is always done from a WING perspective:

- For input routing, input **SOURCES** are the physical connections to WING, while destinations are either **WING CHANNELS** or **OUTPUTS** (i.e. physical outputs);
- For output routing, signal **SOURCES** are any of the possible tap points in WING to send out a digital audio signal, including **INPUT SOURCES**, **BUS**, **MAIN**, **MATRIX**, **USER SIGNAL**, **MONITOR**, and **FX SENDS**, while destinations are the physical outputs available from the desk or additional devices that are connected to it.

Benefits of Effective Routing:

- **Clean Mixes:** Proper routing avoids unwanted signal bleed and ensures each element sits clearly within the mix.
- **Efficient Workflow:** By creating custom routing setups, you can save time during live performances or studio sessions.
- **Creative Possibilities:** Advanced routing unlocks creative options like sending specific instruments to dedicated effects mixes, or managing both FOH and Monitoring from the same desk.

Understanding Routing Interfaces:

Digital consoles such as WING offer visual interfaces for routing, with screens depicting virtual "patches" connecting inputs, outputs, and internal processing modules. For WING, the interfaces are the main touchscreen using the **ROUTING** dedicated button, or software applications such as **WING-Edit**<sup>98</sup> or **Mixing Station**<sup>99</sup>.

---

<sup>97</sup> Source: Gemini AI

<sup>98</sup> See: <https://www.behringer.com/series.html?category=R-BEHRINGER-WINGSERIES>, under the Software section

<sup>99</sup> See: <https://mixingstation.app/>

## Input Routing

**WING** has numerous possibilities when it comes to connecting sources and channels (so called “routing”), effectively enabling audio to ‘flow’ from its source to the WING audio engine for processing and mixing within the desk.

There is a very large choice of no less than 376 input sources that can be found under the **ROUTING→SOURCES** screen, the **SOURCE GROUP** selection includes:

- **LOCAL IN** (8 local XLR inputs on the full-size desk)
- **AUX IN** (8 local 6.3mm inputs on the full-size desk)
- **AES/EBU IN** (2 AES/EBU inputs)
- **OSCILLATOR** (2 internal oscillator sources with various signal options and settings)
- **AES50-A, B and C** (each with 48 inputs)
- **ST CONNECT** (StageConnect™, configurable 32 IN or OUT at line level on a standard XLR/DMX cable)
- **USB AUDIO** (48 inputs from a USB-2.0 port)
- **WLIVE PLAY** (2x 32 inputs from one or two SD cards)
- **DANTE<sup>100</sup>** (64 inputs from either a card or internal module, or 128 inputs if both are installed)
- **USB PLAYER** (4 inputs from the USB stick input)
- **USER SIGNAL** (48 configurable user data path or patches overlapping/referencing sources above)

All Sources above come with their associated **SETTINGS** (*Mono/Stereo/MS, Gain, Polarity, Mute, Phantom, ...*), **ICON**, **COLOR**, and **TAGS**.

The process of “source routing” or “input routing” is the action of associating a **SOURCE** to one of the WING 48 (input/aux) **Channels** (or **Channel Strips**) for mixing their audio within the desk. This is accomplished by pressing the **ROUTING** button on the left of the WING Screen, and selecting the **CHANNELS** tab on the screen, opening the following screen:



There are two routing options: **MAIN** and **ALT**. Both serve the same purpose and can be selected within Channel Strips; There are therefore two routing tables available at the desk.

WING routing tables are write-protected (to avoid major issues during live performances) unless the unlocked padlock [🔓] is selected. With the padlock being green, a Channel Strip can be selected on the left side of the screen and a **SOURCE** entry can be selected from the Sources available on the right side of the screen.

<sup>100</sup> This could be another option

Different groups of SOURCES blocks are available from the SOURCE GROUP pull down menu (see below):



SOURCES include actual HW sources and logical audio paths such as BUS, MAIN, MATRIX and USER SIGNAL, which are either the result of partially mixed audio or a specific/customized selection of Source in the case of USER SIGNAL.

After a console init as shown above, LOCAL IN 1..8 mono sources will already be routed to Channels 1..8, USB AUDIO 1&2 will be combined as a stereo source routed to Aux 1, and Aux 2 will receive USB PLAYER 1&2 as a stereo source. This constitutes the default MAIN routing table. The ALT routing table is empty.

For example, routing WLIVE PLAY sources 1..16 to Channels 9..24 can be done by a click on the +1AUTO button, selecting the first Channel to modify routing for (9), selecting WLIVE PLAY in the SOURCE GROUP pull-down menu and sequentially clicking on the 16 first entries of WLIVE PLAY, resulting in the following screen (and MAIN routing table).

Additional, similar, or different choices for routing could be done for the ALT routing table, offering an alternate set of SOURCES to mix from at the mixing desk. Note that the MAIN/ALT selection at the Channel Strip level is accomplished by selecting either the MAIN or the ALT source for that Channel, i.e. moving from one to the other will possibly select a different source to mix, losing the previous one.



At that point, Channel Strips 9 to 24 can be used to mix the audio data issuing from the first 16 tracks of SD card 1<sup>101</sup>. Channel Strip 1 to 8 can be used to mix the audio data coming from local inputs 1 to 8 at the back of the console, and Aux strips 1 and 2 can be used to mix the audio signals from USB 1 & 2 and the 2 tracks from the USB stick player.

What if the 16 WLIVE PLAY tracks above were representing 8 distinct stereo channels?

WLIVE PLAY sources must be declared as stereo pairs; This is done by returning to the SOURCES tab and selecting the WLIVE PLAY source group, showing all 64 possible entries. Selecting entry 1 and clicking on STEREO in the SETTINGS will automatically 'join' entries 1 and 2 as a stereo pair named CRD1/L and CRD2/R, the same action can then be done for entries 3, 5, 7, 9, 11, 13, and 15, resulting in 8 pairs of stereo sources that can be routed to 8 different channels as described earlier. The pictures below show the screens resulting from the actions we just described.

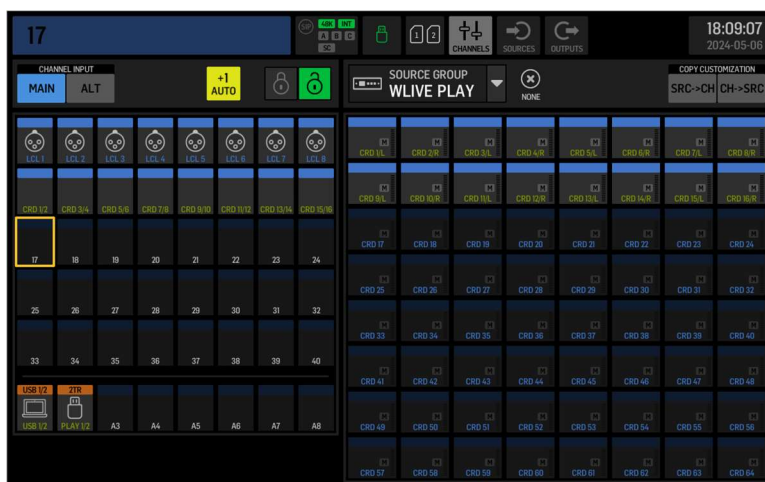

As a result from the operations above, Channel Strips 9 to 16 can now be used to mix the audio data issued from the first 16 tracks of SD card 1. Channel Strip 1 to 8 can still be used to mix the audio data coming from local inputs 1 to 8 at the back of the console, and Aux strips 1 and 2 can still be used to mix the audio signals from USB 1 & 2 and the 2 tracks from the USB stick player.

<sup>101</sup> Note that SD card 1 maps to entries 1..32, and SD card 2 maps to entries 33..64 in the WLIVE PLAY or REC screens

## Output Routing

Output routing works in a similar way to Input routing. This time though, the **OUTPUTS** tab is selected in the **ROUTING** screen, revealing **OUTPUT GROUPS** from a pull-down menu, and representing the physical outputs where audio signals from the console can be routed to, using digital audio sources selected from the **SOURCE GROUPS** pull-down menu and entries.

The selection of output physical connections is as numerous as for inputs and characterizes the console versatility and extended capabilities with 374 physical outputs that can be found under the **ROUTING→OUTPUTS** screen; The **OUTPUT GROUP** selection includes:

- **LOCAL OUT** (8 local XLR outputs on the full-size desk)
- **AUX OUT** (8 local 6.3mm outputs on the full-size desk)
- **AES/EBU OUT** (2 AES/EBU outputs)
- **AES50-A, B and C** (each with 48 outputs)
- **ST CONNECT** (StageConnect™, configurable 32 IN or OUT at line level on a standard XLR/DMX cable)
- **USB AUDIO** (48 outputs from a USB-2.0 port)
- **WLIVE REC** (2x 32 outputs to one or two SD cards)
- **DANTE<sup>102</sup>** (64 outputs from either a card or internal module, or 128 outputs if both are installed)
- **RECORDER** (4 outputs to the USB stick input)

As for source assignments, the console comes with a default output routing right after being initialized. This is shown below with **LOCAL OUT 1..8** receiving **BUS 1L** to **BUS 6L**, **MAIN 1L** and **MAIN 1R**, respectively. Note also that **AUX OUT 7&8** are receiving **MONITOR A&B** by default.



Changing the output routing is made from the **ROUTING→OUTPUTS** screen, with first clicking on the **OUTPUT GROUP** of interest to select the first physical destination you want to assign a WING signal to.

Say we would like to record the first 8 (all stereo) channels of our show as a new session onto SD card 2, along with the resulting show mix on the USB stick of the front panel as a 2-track mix coming from **MAIN1**; The operations one would perform are as follows:

After selecting the **WLIVE REC** group of physical output on the left side of the screen and clicking on any entry in that panel, we need to select where routed signals will be coming from. That selection is possible from the **SOURCE GROUP** pull-down menu on the right side of the screen that offers a list of all possible 'tap points' for getting digital signals from the desk to physical outputs. In our example, we would select the audio signal sources that feed our Channel Strips 1 to 8. Let's further assume our 8 Channel Strips are taking their inputs from **WLIVE PLAY** as described above. SD card 2 maps its 32 entries from 33 to 64 in the **WLIVE PLAY** or **REC**

<sup>102</sup> Could be another option

panels. As we did for input routing, we first select the unlocked padlock [🔓], click on the first entry for SD card 2 (CRD 33) in the WLIVE REC panel on the left side of the screen, click on the +1AUTO button for ease of selection and choose our audio signals to route to our outputs by clicking on the 16 entries in the WLIVE PLAY panel on the right side of the screen, starting at entry CRD1, resulting in the following routing table:

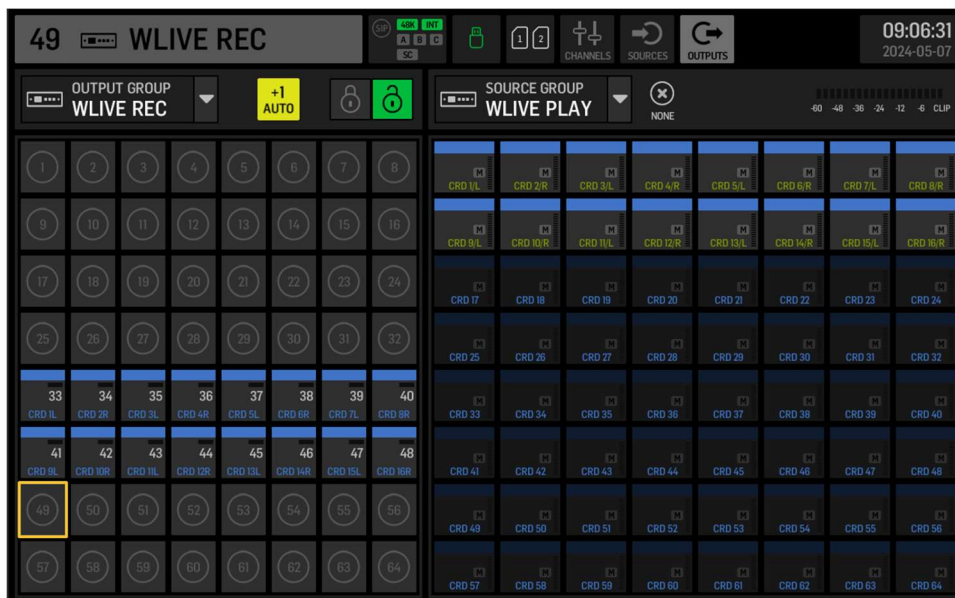

The audio data used for our mix will be recorded to SD card 2, from SD card 1 (only when engaging record on SD card 2 and play on SD card 1, of course).

We also need to set the output routing for recording our live mix; In the ROUTING→OUTPUTS screen, with clicking on the OUTPUT GROUP on the left side of the screen, we select RECORDER and click on the first entry, 1. With the unlocked padlock [🔓] selected and the +1AUTO button engaged, we select MAIN in the SOURCE GROUP on the right side of the screen, and then click on the 1L and 1R entries in the displayed table. This completes our output routing with the following screen:



We can now select the USB recorder and start a 2-channel recording on USB stick, then select the SD card screen, start recording on card 2, select our 8 stereo tracks session and hit play on card 1 and mix our session, simultaneously getting a digital copy of our dry data from SD1 to SD2 and a live mix result as a stereo wav file in the USB stick.



## Advanced Routing Options

All routing scenarios presented above have a restriction when it comes to stereo pairs. The HW limitations of the desk impose stereo pairs to always be in the form [odd-even] SOURCE numbers; i.e. you cannot route a stereo signal to a single channel strip if your two mono sources are connected to say LOCAL IN 2 and LOCAL IN 3, or if they are connected to WLIVE PLAY 1 and WLIVE PLAY 33.

This is where USER SIGNALS come into play, leveraging the internal FPGA routing chip flexibility to remove some of that restriction. A USER SIGNAL is a virtual channel, and proposes two variants: USER SIGNAL and USER PATCHES which we'll detail below:

### USER SIGNAL

A USER SIGNAL can only accept INPUT, AUX or BUS, MAIN or MATRIX channels as source. Setting or assigning sources to USER SIGNAL is done with selecting the ROUTING->SOURCES screen and choosing one of the 24 USER SIGNAL entries in the SOURCE GROUP pull-down menu on the left side of the screen.

Clicking on an entry will display the SOURCE characteristics on the right side of the screen, with SOURCE SETTINGS, ICON, COLOR, POLARITY, and MUTE, and a +ASSIGN button that is used for selecting which channel, tap point (TAP or POST) and whether using stereo, mono, or M/S data as signal(s) for the selected USER SIGNAL entry. If the selected USER SIGNAL entry is stereo, it is possible to choose two totally disjoint sources for each of the L and R paths of the selected USER SIGNAL, such as for example channel 1 and channel 5 that would be routed with WLIVE PLAY 1 and WLIVE PLAY 33 to take our example above, creating a stereo pair that can now be assigned/routed to a single Channel strip thanks to USER SIGNALS. The screenshots below show routing displays for such a case, with channels strips 1 and 5 routed to sources WLIVE PLAY 1 & 5, and channel strip 9 routed to stereo USER SIGNAL 1 that routes channels 1 and 5 as a single stereo pair to itself.





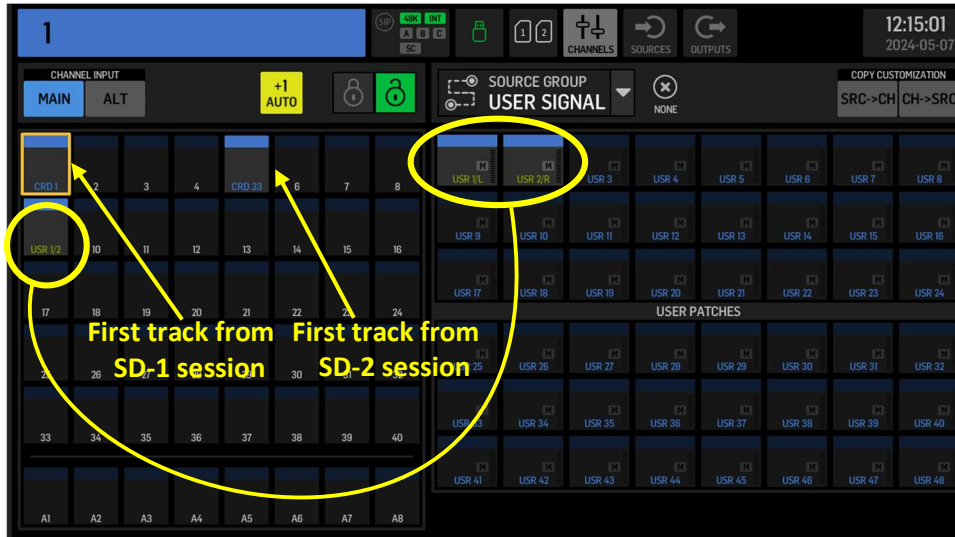

That same USER SIGNAL 1 can also be used as a SOURCE for an OUTPUT, such as for example to record into a DAW on a PC using a USB connection, as a single stereo pair into USB 1&2.

To achieve this, we would click on the first entry of USB AUDIO in the OUTPUT GROUP on the left side of the ROUTING→OUTPUTS screen. With the unlocked padlock [🔓] selected and the +1AUTO button engaged, we select USER SIGNAL as a SOURCE GROUP on the right side of the screen and click on the USER 1L and USER 2R entries in the displayed table. This completes our output routing with the following screen:

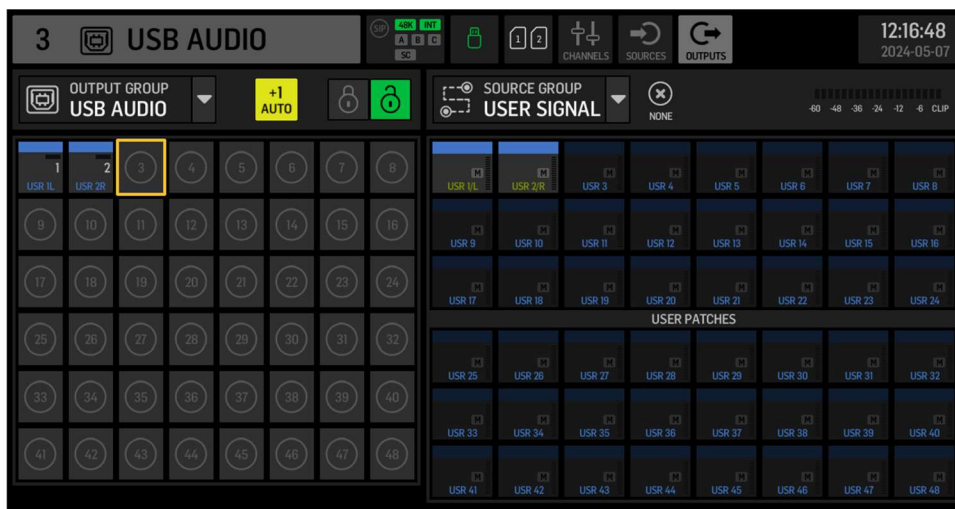

We can then hit play on WLIVE sessions on both SD card 1 and 2, and will get our signals available as a single stereo pair for recording a 2-track session over USB cable to a connected PC.

## USER PATCH

A USER PATCH can be used the same way as a USER SIGNAL but unlike USER SIGNAL, the audio physical SOURCE will directly connect to a USER PATCH, thus bypassing the need for using an intermediate channel strip or set of channel strips.

Setting or assigning sources to USER PATCH is done with selecting the ROUTING->SOURCES screen and choosing USER SIGNAL in the SOURCE GROUP pull-down menu on the left side of the screen and selecting one of the 24 USER PATCH entries in the list. As for USER SIGNAL, clicking on a USER PATCH entry will display the SOURCE characteristics on the right side of the screen, with SOURCE SETTINGS, ICON, COLOR, POLARITY, and MUTE, and a +ASSIGN button that is used for selecting which physical SOURCE will be used. A USER PATCH can accept any of LOCAL IN, AUX IN, AES/EBU IN, AES50 A/B/C, ST CONNECT, USB AUDIO, WLIVE PLAY, DANTE, or USB PLAYER signal as its routed SOURCE.

If the selected USER PATCH entry is stereo, it is possible to choose two totally disjoint sources for each of the L and R paths of the selected USER PATCH, such as routing for example WLIVE PLAY 1 and WLIVE PLAY 33 to USER PATCH stereo entry 26L/26R to use once more our example above, creating a stereo pair that can now be assigned/routed to a single Channel strip.

The screenshots below show routing displays for such a case, with sources WLIVE PLAY 1 & 33 routed to USER SIGNAL 25L/26R, itself routed as a single stereo pair into channel 9.

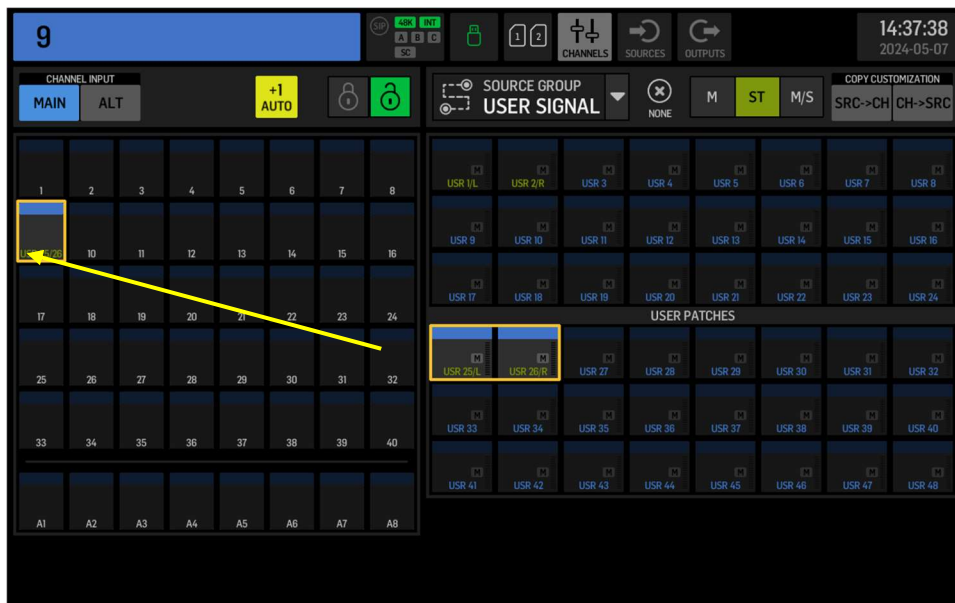
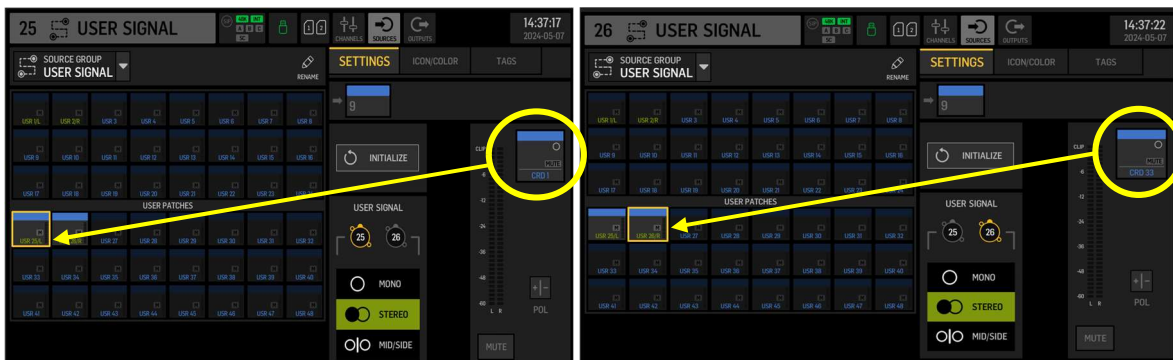

USER PATCH has the advantage of routing simplicity over USER SIGNAL. On the other hand, USER SIGNAL offers more signal processing or mixing capabilities over USER PATCH, to the expense of using intermediate Channels.

## Appendix: Shows, Scenes (Snaps, Snippets, Presets & Audio Clips)

The WING desk has a high level of functionality to manage saving and restoring shows, snaps, snippets and presets, or scenes.

### Shows

A key feature in digital consoles is the ability to save and restore state (in different forms) to easily change from one set to another, or save work for later use. This helps maximize the use of the desk in situations where several bands share the same console, or in recording studios where saving console state is a must have for effectively managing recordings and customer data.

For WING, a **Show** is typically a collection of **up to 1000 Scenes**. Show files contain references to Scene entities, and not the actual data.

Shows can be managed directly from the WING screen via the LIBRARY button or using MIDI commands (see below). One can create a Show, open, or delete it. There can be only a single active Show at any time. Snaps, Snippets, FX or Channel Presets or Audio Clips can be added to the current Show, they can also be re-organized using the options provided in the LIBRARY section. When added to a Show file, they are referenced as Scenes.

Users can 'navigate' up and down [i.e. loading Scenes] in the current Show using the Show Control buttons dedicated to that effect [GO, NEXT, PREV, GONEXT<sup>103</sup>, GOPREV<sup>104</sup>], OSC or MIDI commands, or wapi calls. Some of the Show items can also be marked as 'skip' for a quick avoiding loading them during navigation. Show items can also be marked with a 'link' tag to enable simultaneous loading of multiple items during navigation.

Please refer to the Behringer documents on how to use Shows<sup>105</sup>.

### Scenes

A Scene can represent anything used in a Show. It can refer to a Snap, a Snippet, a Channel of FX Preset or an Audio Clip, or a combination thereof. Each single entry in a Show file is a separate Scene that can be loaded using the LIBRARY navigation options.

Scene names can be built in two parts, separated with a '~' character (like in "SnapName~Explanation" and be displayed on two lines, with the part left of the '~' char being in large font letters and the part right of the '~' char displayed as a second line in smaller characters. This can be handy for adding explanation or use for the Scene element to name (see below).



<sup>103</sup> GONEXT means Go to Next item, i.e. the next item is first pointed to and a GO command is then executed.

<sup>104</sup> GOPREV means Go to Previous item, i.e. the previous item is first pointed to and a GO command is then executed

<sup>105</sup> Available at: [https://mediadl.musictribe.com/download/software/behringer/WING/WING\\_Firmware\\_1.13\\_GUI-Description.pdf](https://mediadl.musictribe.com/download/software/behringer/WING/WING_Firmware_1.13_GUI-Description.pdf)

## Snaps

A Snap file contains the full set of WING parameters, optionally associated with Scopes that list the set of parameters of interest at the time the Snap was created. Scopes can be changed at load time if needed. They can also be modified as needed and saved.

## Snippets

A Snippet file allows recording of any WING parameter changes as well as manually adding/removing of parameters using the Library buttons ADD ITEMS and REMOVE ITEMS.

- REC FOCUS defines which parameters are observed during REC active.
- LOAD FOCUS allows loading a parameter set from any existing snippet.
- When a snippet is saved or updated, the *current* values of all parameters (in FOCUS) are written to the file and cannot be changed once recorded to INT or USB file.

## Presets

- FX and CHANNEL Presets
  - Presets contain target FX slot(s) and target channel/scope information; When used within a Show, the Preset data is instantiated within the Show as a Scene, and the same Preset can be used to load different FX engines / channels (with different scope)). After adding a Preset to a Show, just change settings and click UPDATE SCENE (don't forget to save the show).
  - If you set the target FX slot of a Channel Preset (one of the inserts) to NONE, the insert is switched off when loading the Preset.
  - Premium effects can only be loaded into FX engines 1-8.
- CHANNEL Presets
  - Gain and Phantom power status which are part of the source associated to the channel used to create the preset are saved with the presets, but are not loaded by default when applying the preset to another channel; You will have to enable/select the “conn” setting box (see red arrow below) to ensure gain and phantom power are restored; This will also affect the source to the destination channel..

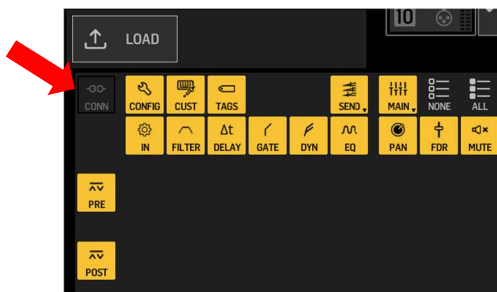

- If you set the target FX slot of a Channel Preset (one of the inserts) to NONE, the insert is switched off when loading the Preset.
- Presets can contain insert effect data; Care must be taken when loading them, as effect engines might be used in other Channels.
- Channel/Aux/Bus/Main/Matrix Presets can only be loaded into corresponding Channel of course.

- Bus Presets contain Channel feeds into the bus (FEED scope).
- Old ROUTING Presets can be loaded as Snapshots (scope is set accordingly). For new routing Presets, just use Snapshots and use Scope to limit loading to routing parameters only.

## Audio Clips

WING Show control enables using Audio Clips as Scene entities. One can therefore include a reference to a wav file from a USB stick or stored in WING's internal file system as a Scene that can be part of a Show file. Library navigation functions can be used to launch (load) Audio Clips that are part of a Show as they do for any other Scene entity.

## Controlling Scenes and Shows via MIDI

As mentioned in the MIDI chapter earlier in this document, Scenes and Show control can be managed using MIDI commands sent to MIDI channels 7, 8 and 9 as below:

### MIDI Scene Change (on MIDI Ch 7):

CC32: bank (LSB only), PC 1..128	B62000..B620FF, C600..C67F
----------------------------------	----------------------------

### MIDI Show Control (on MIDI Ch 8 & Ch 9):

CH8 PC 1..128 → Scene Tag #1..#128	C700..C77F
CH9 PC 1 → Scene GO	C800
CH9 PC 2 → Scene PREV	C801
CH9 PC 3 → Scene NEXT	C802
CH9 PC 4 → Scene GO PREV	C803
CH9 PC 5 → Scene GO NEXT	C804

All Library items can be recalled with MIDI Program Change commands (including Bank LSB when > 128) on MIDI Ch 7 when enabled. As a result, one can address 128 Scenes using Tags/Program Change on MIDI Ch 8, and all 1000 Scenes via Bank/Program Change on MIDI Ch 7.

## Item Tags and arbitrary MIDI data

Scenes can be 'tagged', allowing easy MIDI and CC button recall. Tags work as follows:

- An item Tag can be set to any Library item (Scene, Snip, Clip, Presets or Audio Clip) from the **Show** tab under LIBRARY.
- Tags starting with #1 .. #128 [to match with MIDI data 0..0x7f] can be recalled with a corresponding MIDI program change on MIDI Ch 8, or with custom control buttons [using the SCENE RECALL setting for said buttons].
- On MIDI Ch 7, you can use Tags up to #16384 with #BANK, PGM; For example #2.1 (hex: B62001C600) is the same as #129.

- Be aware that **Tags** are not necessarily in the same order as MIDI program changes are. So, recalling items using **Tags** on MIDI Ch 8 and recalling items using Program Change increments on MIDI Ch 7 May not recall items in the same order.
- A **Tag** can be assigned to several Library items; In that case, WING doesn't check for exclusiveness of **Tags** and the first one found in the list of Library items wins.
- Additionally, you can add/send arbitrary MIDI data with each Scene recall (use hexadecimal notation, separator is optional, i.e. *C002* or *B0,01,7F*). This arbitrary MIDI data can be part and save with an empty snippet, enabling a very flexible control of external MIDI devices directly from the console.

## Appendix: Scopes and Safes

**Scopes** are specific indicators that are used to focus (or restrict) an operation on certain parameter sets of the console when dealing with Scenes or at INITIALIZE CONSOLE time.

**Safes** are specific indicators that are used to prevent the modification of selected parameter sets of the console when dealing with Scenes

### Library Scopes<sup>106</sup>

When editing scopes during a Library action, a list of icons displays on the screen as shown below:



Most of them are explicit, but some (listed below) regroup several items or parameters under a single icon that can be selected or un-selected depending on the scope edit or recall operation the user wants to perform. The paragraphs below list the different parameters that are covered by these icons.

### CONTENTS Scopes (orange Icons)

**CUST:** Icon / Name / Color / Light on, off

**TAGS:** Custom Tags / DCA, Mute, Talk Tags

**CONN:** Source A, B / Main, Alt Status / Input Select Status  
(No source Mute or Mono-Stereo-MS)

**IN:** Trim / Balance / Phase flip

**FILTER:** LPF / HPF / TILT (Max, AP90, AP180) with all settings

**DELAY:** On, Off Status / Delay Time

**GATE:** All settings of the gate (Type / Settings / Side chain ...)

**DYN:** All settings of the dynamic (Type / Settings / Sidechain ...)

**PRE:** Assignment of the FX Plugin (without FX settings)

**POST:** Assignment of the FX Plugin (without settings), Automix Settings (X, Y, Amount)

**EQ:** All settings of the EQ (including type of EQ bands), TAP EQ Settings in Bus Sends

**PAN:** Pan and Width Settings

**MAIN[1..4]:** Levels/ On, Off Settings / Pre, Post Settings

**SEND[Bus 1..16, Mtx 1..8]:** Levels / Pan Settings / All status (On, Off / Mode Link / Send Pan / Send Mute / Mode)



<sup>106</sup> Many thanks to Andy Lauer for providing these details.



FDR: Fader Levels

MUTE: Channel Mutes (no Source Mute)

CONFIG: Process Order / Tap Point / Solo Bus Status

## CONFIGURATION Scopes (blue icons)

### CONFIG

**Monitor Page - Monitor Control:** Mute Status, Output Status

**Monitor Page - Talkback:** – Talk Channel Assign, All Talkback Preferences

**Monitor Page – Monitor A and B:** All settings and Align options (Delay / EQ / Invert)

**Setup – Audio:** Main Link, DCA Mutegroups, Startup Main Mute, Automix X - Y (enable status),

Solo Mode, Channel Solo, Bus Solo, Main Solo, Matrix Solo, Source Solo

**Setup – Surface:** Main Meter Dropdown, Main Meter Tap, Show Source On Scribble

**SD Card:** All settings except “Link Status”

**RTA:** Range, Decay, Detector, Autogain on/off, Fixed gain value

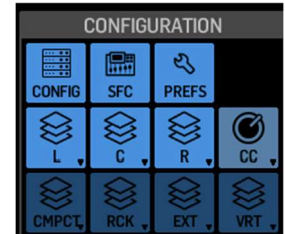

### SFC

**Setup – Audio:** Mutegroup/SIP Override, Exclusive Solo, Solo Follows Select, Select Follows Solo, BUS/MAIN SoF Activates Solo

**Setup – Surface:** All The “Lights” settings, Full Fader Paging, Channel Meters, Bus Meters, Main Meters, Matrix Meters, DCA Meters, Screen Follows Ch Strip, Ch Autoselect, User Layer Link, Use F1- F3 As Custom Controls, Right Section Sends On Fader, SOF Buton, Show SOF Frame, Alternative SOF Mode, Sel Dbl Click

### PREFS

**Setup – General:** Show Meter Page When Locked, Use CRSR/WHEEL For Parameters, Touch Fader Select, Touch Fader Res, Mouse Disables Touch, Mouse Speed value

**Setup – Surface:** Tap Tempo Flash, Fader Speed

**Setup – Remote:** Complete Midi Remote Control

**Setup – DAW:** All DAW Settings

### L, C, R, CC, CMPCT, RCK, EXT, VRT

Refer to layers in the console. Some are specific to the Compact and Rack models.

CC refers to the Custom Controls that can be edited in your console.

## Not Saved in Snapshots:

**Monitor Page – Monitor Control:** DIM and MONO Buton, TALK A and TALK B Buton

**Setup – General:** Console Name, Time Date, USB Host Speed, Confirm Library Load, Confirm Library Update

**Setup – Audio:** Audio Clock (Rate and Sync Source dropdowns), “INPUT SELECT” switch status, Startup Main Mute, Global Input Select Override, USB AUDIO (In/Out dropdown)

**Setup-Remote:** HA Remote (All settings), Network Settings (dropdown incl. addresses), Remote Lock (OSC / TCP)

**4 Track Recorder:** Settings (2/4 Ch – 16/24 Bit)

**SD-Card:** Link Status

## Console Init Scopes<sup>107</sup>

In the INIT screen, a screen (like the Library Scopes one) will display the following, along with a large INIT button.



the following settings/parameters will only be initialized/"recalled" if you initialize the desk with **ALL** parameters/settings selected. If anything is taken out of the initialization scope the settings below won't be initialized.

- Clock rate and (sync) source
- Global input select
- USB Audio channel configuration
- Startup main mute
- Global input select override
- HA Remote settings
- The OSC Setting in Setup -> Remote -> Remote Lock
- The DAW control preset.

The following settings will never be initialized/"recalled".

- Console Name
- USB Host Speed
- Clock
- Everything in Setup -> Remote -> Network (IP Adress etc.)
- The TCP Setting in Setup -> Remote -> Remote Lock
- Talk, Headphone and Monitor level (physical knobs on the surface)
- Monitor Mono and Dim (physical buttons on the surface)
- Talk A and Talk B on/off (physical buttons on the surface)
- Everything in the Library

<sup>107</sup> From @sinste from the <https://behringer.world> forum

## Global Safes

At the top right of the “LIBRARY” screen, is a sign that can take one of the two following icons/colors:



, or



, depending on the contents of the referring page. This is used for **Global Safes**.

**Global Safes** are a series of *parameter indicators* that are used to prevent the modification of the values of the respective console parameters. They are listed as a screen of icons as shown on the right:

They are grouped under classes such as “CHANNEL”, “AUX”, “BUS”, “MAIN”, “MATRIX”, “SOURCE”, “OUTPUT”, “DCA”, “MUTEGROUP”, “FX”, and “CONFIGURATION”



When clicking on a *parameter indicator*, it will turn **red** and change the state/color of the Global Safes logo on top of the screen, reminding you that *at least one* Global Safe is engaged.

Each parameter indicator represents all the parameters belonging to a CHANNEL, an AUX, ..., or an FX. Some indicators will represent a set of configuration parameters, such as CONFIG, SURFACE, ..., CC [Custom Controls].

When selected [RED], they will **prevent the update/modification** of their respective section when executing a scene **LOAD** operation (snap or snip), or one of the **GO** functions. As a result, Global Safes are a great way to protect certain sections of your console while running a show and using the Show functions of the console.

Note that the **RESTORE** (in LIBRARY) and **INITIALIZE CONSOLE** (in SETUP) functions do not take Global Safes into account and will modify/re-initialize them.

## Appendix: WING Startup Control

During startup, the console will automatically load a Show, Snapshot or Snippet with the following name when placed in a folder called **STARTUP** in the root of the internal data partition. This can be bypassed when holding the LIBRARY button during power up. Files have to start with the letters “STARTUP”, such as

- **STARTUP.show**, or **STARTUP\_myfile.show** for ex.
- **STARTUP.snap**, or **STARTUP\_myfile.snap** for ex.
- **STARTUP.snip**, or **STARTUP\_myfile.snip** for ex.

## Appendix: MIDI Setup for REAPER Control Surface Use

This section is not directly related to programming, but can prove useful when it comes to using WING in a studio, with REAPER™ as a companion DAW software.

The simplest and most complete way to connect all elements together is to use MIDI over USB, MCU mode. This will not only provide a link for REAPER's audio to be sent to WING for audio processing, but will also enable several MIDI channels that can be called for using WING as a control surface and transport controls for REAPER.

In order to achieve this, you will first make sure you have a USB connection between your WING and PC. You can at any time flip between WING controls and MIDI DAW control using the **DAW Remote Control** button circled in red below and situated left of the group of 8 buttons above the Jog Wheel:

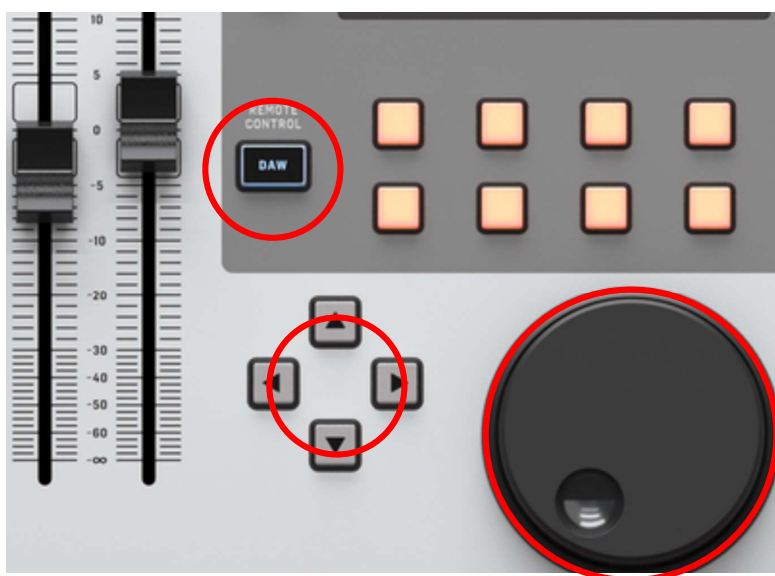

Shown above: the **DAW Remote Control** button, the **Jog wheel**, and the 4 **directional** keys mentioned in the coming pages.

## REAPER Audio Setup

You then adjust REAPER ASIO interface (and WING setup) to get ASIO channels for audio. The routing on your WING must map USB Inputs to your channel strips. Faders for channel strips should be ideally set to 0dB. Main strip fader should for the time being be set to -∞.

The figure below shows an example for a 16 in/16 out ASIO setup (Options→Preferences→Audio→Device).

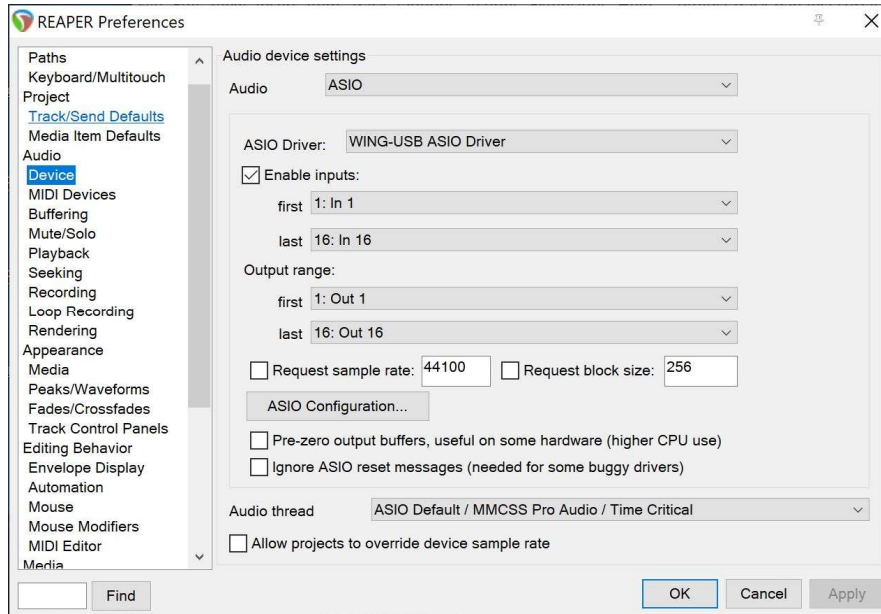

## MIDI

MIDI includes two parts (besides the USB connection mentioned above). The first one is relative to setting WING as a DAW control surface, the second one relates to transport controls.

REAPER DAW control surface is obtained through the SETUP→Remote screen. In the left part of the screen, you will choose USB MIDI and MCU+2xExtenders for a full 24 strips DAW control.

## WING MIDI setup

See below the corresponding WING setup screen which can be set from the SETUP-→REMOTE WING screen. We show here the setup for using a full 24 WING channel strips for MIDI remote control of REAPER, using the MCU + 2 distinct extenders over USB MIDI. You can limit the surface to the controller or controller + 1 extender.



Transport controls proposed here include REW, Fast Forward, Stop/Play/Pause, Scrub, Jog Wheel and more, directly from the lower section of the WING controls. A simple/classic example of implementation is shown below and the setup of these functions is performed after pressing the WING controls' View button and assigning keys one by one using the WING main LCD screen.

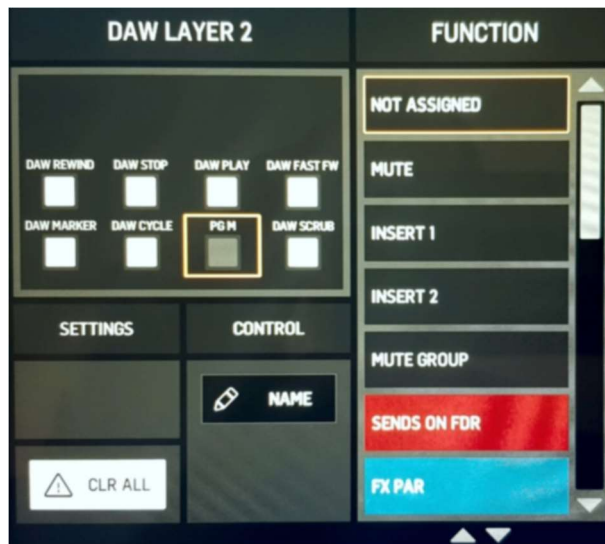

Once modified, the custom transport button layouts can be saved as WING presets. A simple REAPER Control Surface preset is available for download at [https://drive.google.com/file/d/1WpAKkxgASse-X6bllRm5-7QDyxriDRuR/view?usp=drive\\_link](https://drive.google.com/file/d/1WpAKkxgASse-X6bllRm5-7QDyxriDRuR/view?usp=drive_link), resulting in the following "DAW LAYER 2" Control Section assignments<sup>108</sup>:



<sup>108</sup> The 3 other layers, and the rest of the console settings, are left untouched

## REAPER MIDI setup

REAPER needs a few simple MIDI settings to correctly enable WING acting as DAW control surface. When USB is connected, 4 WING MIDI devices appear in the REAPER MIDI devices panel, accessible under **Options→Preferences→Audio→MIDI Devices**. The MIDI ID values are managed by REAPER, but can be set as needed, making sure active/enabled device numbers don't duplicate from one active MIDI device to another. This is shown below:

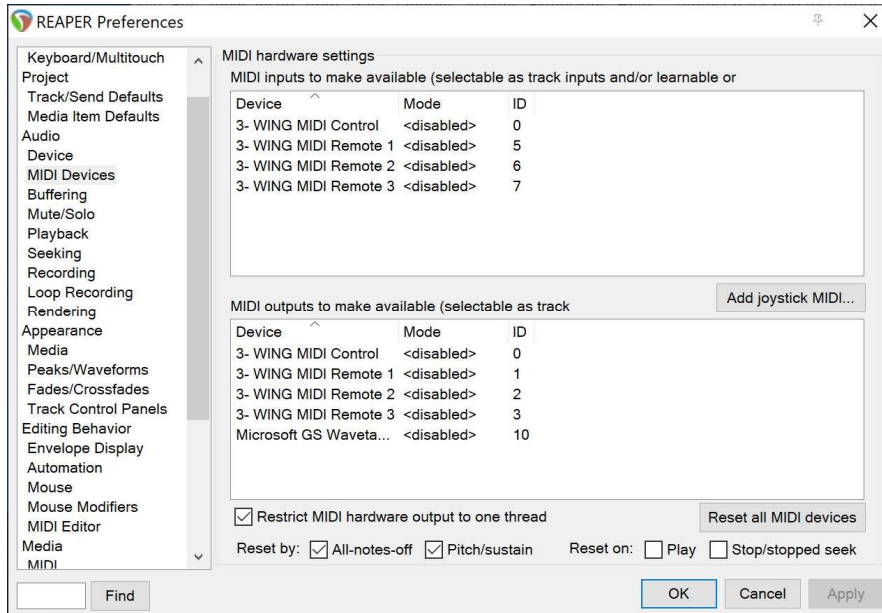

In the case of DAW control use, all WING MIDI devices above must remain <disabled> in the REAPER MIDI Devices panel to be used as a control surface communication MIDI device; REAPER will report errors otherwise.

Remember we have setup WING as USB/MIDI, MCU+2xExtenders to cover three times 8 faders, so the full set of channel strips of WING can be used as surface control strips for REAPER.

In the REAPER control Surface panel (**Options→Preferences→Control/OSC/Web**), you will need to add three separate MCU controllers, the first one is a Mackie Control Universal device. Controllers 2 and 3 are Mackie Control Extender devices. Each device will connect to a WING MIDI remote device [1, 2, 3] respectively, ensuring the surface offset parameter is set accordingly to its respective WING group of 8 channel strips. The 4 figures below show an example of REAPER MIDI setup<sup>109</sup>.

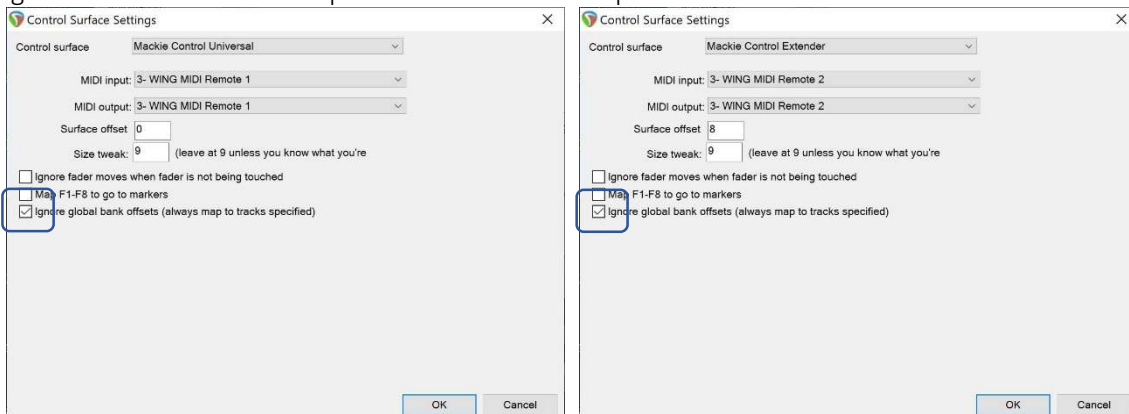



<sup>109</sup> Note that you may have more than one set of WING MIDI remote control, 1, 2, and 3 showing depending on your configuration, or depending on the system state at last reboot or MIDI drivers enable state.

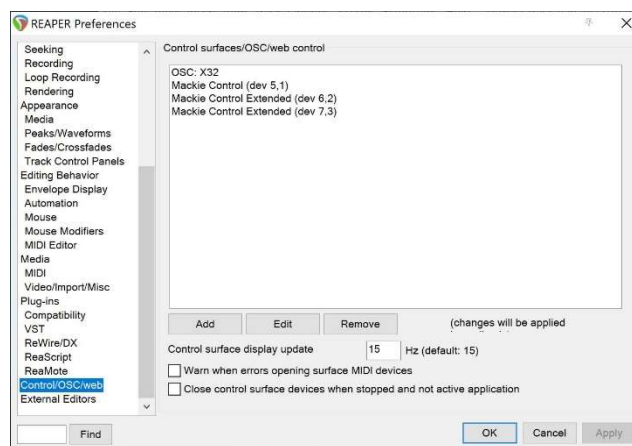
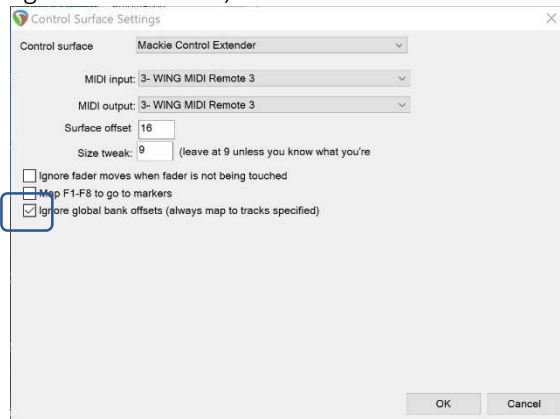

Note the “Surface offset” changes as we set MCU, MCE #1 and MCE #2



: If the “ignore global bank offsets” flags are **not** checked in the REAPER MIDI surface control setup panels above, using the  and  WING buttons will enable you to navigate left and right in the REAPER tracks if more than 24 REAPER tracks are available. The current global start index is shown at the top left of the DAW transport scribbles (“01” circled in red below)



One last setting in REAPER consists in setting the fader scale to values matching WING -144dB→10dB faders. This can be done in the Options→Preferences→Track Control Settings panel by setting the min Volume fader to -144dB, the max to +10dB and selecting a shape type of Default, as presented below:

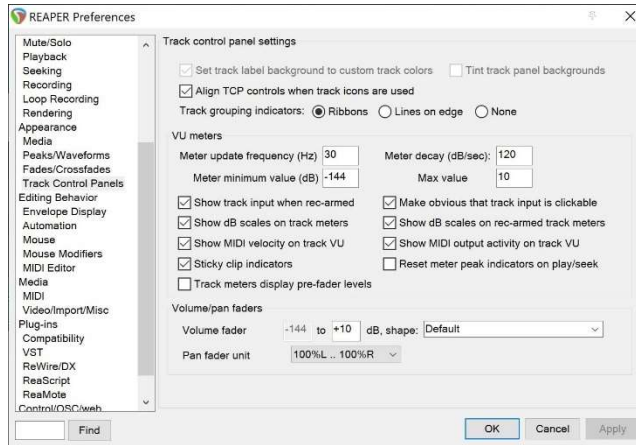

With the settings above, and WING DAW mode setup to USB MIDI, MUC+2xExtenders, you now have a 24 channel strips DAW surface control to manage REAPER tracks (Volume, Solo, Select, Mute) from your WING, and vice-versa (i.e. changes made on a surface (WING or REAPER) will reflect on the other); REAPER tracks' Pan control can be achieved using the 4 rotary knobs in the WING control zone, situated just below the "Custom Controls" silkscreened text. The UP and DOWN buttons on the left of the control zone can be used to navigate within REAPER strips as they are mapped to the WING surface strips.

REAPER tracks Rec/arm is possible using the buttons from the lower row of buttons in the WING control zone. The picture below shows Bass and A\_Guit being armed for recording:



The 4 directional keys located at left of the Jog wheel will navigate into the REAPER audio window (i.e. identical to moving the audio window elevators). The WING Jog wheel will move the REAPER audio cursor left and right (sometimes with a slight lag), and if the Play and Scrub buttons are simultaneously active, moving the wheel will scrub through audio after a small timeout not moving the wheel.

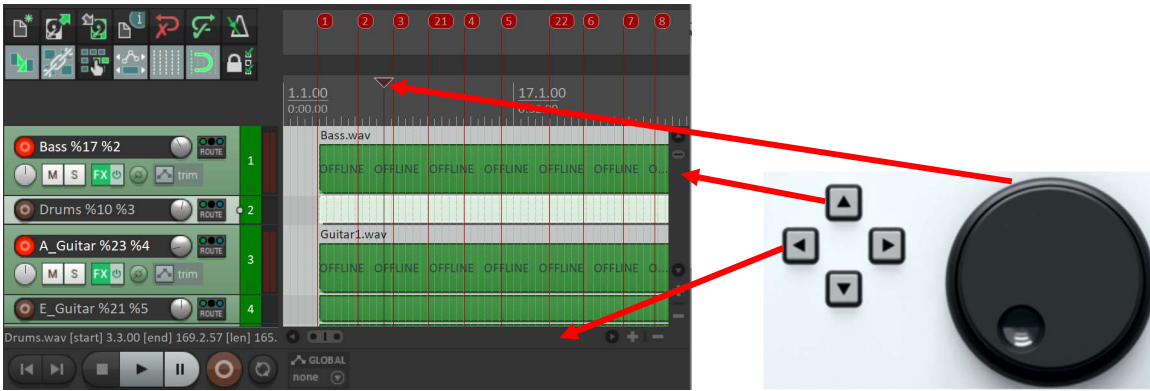

Flip to the WING audio standard controls and move the WING Main fader(s) to get some audio out, remember all other active USB inputs should be set at 0dB.

Flipping back to DAW Remote mode and press the Play button. REAPER will start playing audio; the audio signal will flow to WING using USB/ASIO drivers, and will be managed by the WING audio engines. The faders on WING (in control surface mode) act as remote controls to REAPER track faders (and vice-versa) using USB MIDI.

All set!

**Important note on USB & MIDI:** Changing the clock rate or number of USB Audio channels on WING causes USB to disconnect for a few seconds (including MIDI). On certain operating systems, this may also reset already active MIDI connections. This could happen when loading snapshots with different clock rate or USB Audio configuration.



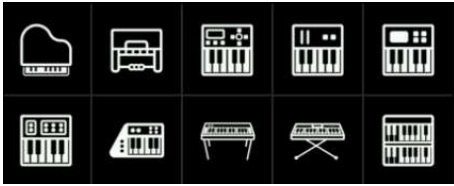

Keys:  
[400...409]

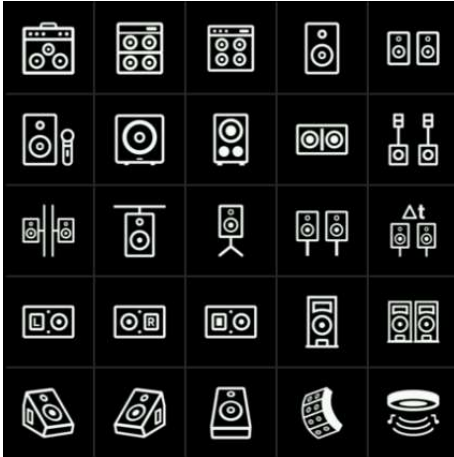

Speakers:  
[500...524]



Specials:  
[600...614]

## Appendix: WING Colors

WING colors are used in several areas such as channel strip color, scribble color, etc. The known colors are shown below and indexed as values 1 to 12:

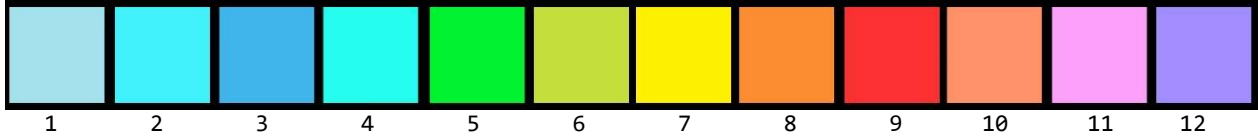

- 1 gray blue
- 2 medium blue
- 3 dark blue
- 4 turquoise
- 5 green
- 6 olive green
- 7 yellow
- 8 orange
- 9 red
- 10 coral
- 11 pink
- 12 mauve

## Appendix: WING GPIOs:

### Description

The WING digital mixing console is offering 4 GPIOs (General Purpose Input/Output) which can be very useful in the studio or live situations. This paragraph shows how to use them in different modes. Let's look at what GPIOs can offer.

At the rear of the console, two TRS jack sockets provide connections to 4 GPIOs. Each of the TRS sockets is depicted below. Lug L3 is common to the 2 GPIOs supported by each socket. Lugs L1 and L2 are respectively used for GPIO 1 or A, 2 or B or 3 or C, 4 or D, depending on the socket used.



WING GPIO 'mode' settings can be any of the following: TGLNO, TGLNC, INNO, INNC, OUTNO, OUTNC. These are represented by OSC patterns `/ct1/gpio/1..4/mode`, and correspond to:

TGLNO	Toggle, Normally Opened
TGLNC	Toggle, Normally Closed
INNO	Input, Normally Opened
INNC	Input, Normally Closed
OUTNO	Output, Normally Opened
OUTNC	Output, Normally Closed

WING GPIO 'state' values can be 0 for `open/OFF` (light off), or 1 for `close/ON` (light on). These correspond to OSC patterns `/ct1/gpio/1..4/gpstate`.

### Electrical connections

- **INNO / INNC:** The console provides approx. 5V between A/B/C/D and Common. The application of a short, dropping voltage to 0V will change the state of the respective GPIO between `open` and `close`, depending on the `NO/NC` mode.
- **OUTNO / OUTNC:** The console provides approx. 5V between A/B/C/D and Common; The voltage presented by the console goes from near 5V to 0V depending on the state (`open` or `close`) and the `NO/NC` mode of the respective GPIO.
- **TGLNO / TGLNC:** This is to toggle the internal state of the GPIO. The console provides approx.. 5V between A/B/C/D and Common; changing the state of the respective GPIO does not change the voltage provided by the console.

As a general statement, care should be taken when connecting external devices to console. A partial circuit of GPIO implementation is shown here for reference:

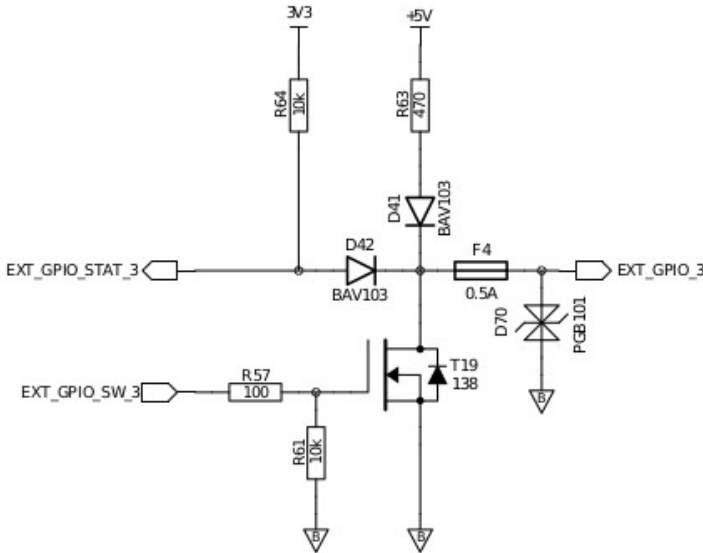

From the schematic above, we can see a 470 Ohm resistor in series with a diode and a 500mA polyfused going to the GPIO port. A max current of approx. 100mA is therefore available for connecting a small relay or an LED. TVS diode D70 protects against electrostatic discharge (ESD).

## Power-on delay

Wing GPIOs can be set to provide a **one-time Power-on delay** of up to 30s that can be used with `OUTNO / OUTNC` modes. This can be quite useful when one needs to power sync external gear with the console.

Note nevertheless GPIOs will always turn **ON** for a short period of time while powering on and booting up, before getting to their respective programmed state and a possible delay applies.

## GPIO precedence on USER/LAYER CC GPIO function

The programming of GPIO takes precedence on a possible USER CC GPIO setup; If for example you have set GPIO 1/A to `MODE OUT-NC` and with a FLAG set to `DELAY 10S` for example, a further USER/LAYER CC button programming with FUNCTION set to `GPIO` will have no effect. If GPIO 1/A is programmed to `MODE OUT-NC` and has a FLAG set to `A-TOGGLE` or `A-PUSH` for example, then a further USER/LAYER CC button programming with FUNCTION set to `GPIO` will work when pressing the respective button as toggle or push, as programmed for the USER/LAYER CC button (i.e. GPIO 1/A can be FLAG `A-TOGGLE` and work as `A-PUSH` if the USER/LAYER CC button is set so GPIO 1/A can be FLAG `A-PUSH` and work as `A-TOGGLE` if the USER/LAYER CC button is set so).



## Appendix: MCU [DAW BUTTONS] commands list

OSC	MCU action	MIDI (port 4)		OSC	MCU action	MIDI (port 4)
T1	STOP	90, 5D, 7F/00		V7	BUSES (VIEW)	90, 43, 7F/00
T2	PLAY	90, 5E, 7F/00		V8	OUTPUTS (VIEW)	90, 44, 7F/00
T3	RECORD	90, 5F, 7F/00		V9	USER (VIEW)	90, 45, 7F/00
T4	REWIND	90, 5B, 7F/00		V10	MIX (VIEW)	
T5	FAST FWD	90, 5C, 7F/00		V11	EDIT (VIEW)	
T6	MARKER	90, 54, 7F/00		V12	TRANSPORT (VIEW)	
T7	NUDGE	90, 55, 7F/00		V13	MEM/LOC (VIEW)	
T8	CYCLE	90, 56, 7F/00		V14	STATUS (VIEW)	
T9	DROP	90, 57, 7F/00		V15	ALT (VIEW)	
T10	REPLACE	90, 58, 7F/00		AU1	READ/OFF (AUTOM)	90, 4A, 7F/00
T11	SCRUB	90, 65, 7F/00		AU2	WRITE (AUTOM)	90, 4B, 7F/00
T12	SHUTTLE			AU3	TRIM (AUTOM)	90, 4C, 7F/00
T13	RETURN TO ZERO			AU4	TOUCH (AUTOM)	90, 4D, 7F/00
T14	GO TO END			AU5	LATCH (AUTOM)	90, 4E, 7F/00
T15	IN			AU6	OFF (AUTOM)	
T16	OUT			AU7	FADER (AUTOM)	
T17	PRE			AU8	PAN (AUTOM)	
T18	POST			AU9	MUTE (AUTOM)	
T19	ONLINE			AU10	SEND (AUTOM)	
T20	QUICK PUNCH			AU11	SEND MUTE (AUTOM)	
N1	UP (NAV)	90, 60, 7F/00		AU12	PLUG-IN (AUTOM)	
N2	DOWN (NAV)	90, 61, 7F/00		SY1	SHIFT	90, 46, 7F/00
N3	LEFT (NAV)	90, 62, 7F/00		SY2	OPTION	90, 47, 7F/00
N4	RIGHT (NAV)	90, 63, 7F/00		SY3	CTRL	90, 48, 7F/00
N5	ZOOM	90, 64, 7F/00		SY4	ALT	90, 49, 7F/00
N6	BK <	90, 2E, 7F/00		SY5	SAVE	90, 50, 7F/00
N7	BK >	90, 2F, 7F/00		SY6	UNDO	90, 51, 7F/00
N8	CH <	90, 30, 7F/00		SY7	CANCEL	90, 52, 7F/00
N9	CH >	90, 31, 7F/00		SY8	ENTER	90, 53, 7F/00
A1	TRACK (ASSIGN)	90, 28, 7F/00		SY9	EDIT MODE	
A2	SEND (ASSIGN)	90, 29, 7F/00		SY10	EDIT TOOL	
A3	PAN (ASSIGN)	90, 2A, 7F/00		OT1	FLIP	90, 32, 7F/00
A4	PLUG-IN (ASSIGN)	90, 2B, 7F/00		OT2	GROUP	90, 4F, 7F/00
A5	EQ (ASSIGN)	90, 2C, 7F/00		OT3	NAME/VALUE	90, 34, 7F/00
A6	INST (ASSIGN)	90, 2D, 7F/00		OT4	TIME/BEATS	90, 35, 7F/00
A7	SEND A (ASSIGN)			OT5	CLICK	90, 59, 7F/00
A8	SEND B (ASSIGN)			OT6	SOLO	90, 5A, 7F/00
A9	SEND C (ASSIGN)			OT7	FOOTSW A	90, 66, 7F/00
A10	SEND D (ASSIGN)			OT8	FOOTSW B	90, 67, 7F/00
A11	SEND E (ASSIGN)			OT9	DEFAULT	
A12	INPUT (ASSIGN)			OT10	SUSPEND	
A13	OUTPUT (ASSIGN)			OT11	BYPASS	
A14	ASSIGN (ASSIGN)			OT12	RECRDY ALL	
A15	SHIFT (ASSIGN)			E1	CUT (EDIT)	
A16	MUTE (ASSIGN)			E2	COPY (EDIT)	
F1	F1	90, 36, 7F/00		E3	PASTE (EDIT)	
F2	F2	90, 37, 7F/00		E4	SEPARATE (EDIT)	
F3	F3	90, 38, 7F/00		E5	CAPTURE (EDIT)	
F4	F4	90, 39, 7F/00		E6	DELETE (EDIT)	
F5	F5	90, 3A, 7F/00		E7	ASSIGN (EDIT)	
F6	F6	90, 3B, 7F/00		E8	COMPARE (EDIT)	
F7	F7	90, 3C, 7F/00		E9	BYPASS (EDIT)	
F8	F8	90, 3D, 7F/00		E10	INS/PARAM (EDIT)	
V1	GLOBAL (VIEW)	90, 33, 7F/00		SP1	FADER TOUCH [MUTE]	
V2	MIDI (VIEW)	90, 3E, 7F/00		SP2	V-POT CTRL [SEL/SOLO]	
V3	INPUTS (VIEW)	90, 3F, 7F/00		SP3	RECRDY CTRL [SEL]	
V4	AUDIO TRACKS (VIEW)	90, 40, 7F/00		SP4	AUTO [SEL]	
V5	INSTRUMENT (VIEW)	90, 41, 7F/00		SP5	V-SEL [SEL]	
V6	AUX (VIEW)	90, 42, 7F/00		SP6	INSERT [SEL]	

## Appendix: MCU [DAW V-POTS] commands list

OSC	MCU action	MIDI (port 4)		OSC	MCU action	MIDI (port 4)
M1P	V-POT M1 Push	90, 20, 7F/00		M1	V-POT M1	B0, 10, 01/41
M2P	V-POT M2 Push	90, 21, 7F/00		M2	V-POT M2	B0, 11, 01/41
M3P	V-POT M3 Push	90, 22, 7F/00		M3	V-POT M3	B0, 12, 01/41
M4P	V-POT M4 Push	90, 23, 7F/00		M4	V-POT M4	B0, 13, 01/41
M5P	V-POT M5 Push	90, 24, 7F/00		M5	V-POT M5	B0, 14, 01/41
M6P	V-POT M6 Push	90, 25, 7F/00		M6	V-POT M6	B0, 15, 01/41
M7P	V-POT M7 Push	90, 26, 7F/00		M7	V-POT M7	B0, 16, 01/41
M8P	V-POT M8 Push	90, 27, 7F/00		M8	V-POT M8	B0, 17, 01/41
E1P	V-POT EXT1 Push			E1	V-POT EXT1	
E2P	V-POT EXT2 Push			E2	V-POT EXT2	
E3P	V-POT EXT3 Push			E3	V-POT EXT3	
E4P	V-POT EXT4 Push			E4	V-POT EXT4	
E5P	V-POT EXT5 Push			E5	V-POT EXT5	
E6P	V-POT EXT6 Push			E6	V-POT EXT6	
E7P	V-POT EXT7 Push			E7	V-POT EXT7	
E8P	V-POT EXT8 Push			E8	V-POT EXT8	
E9P	V-POT EXT9 Push			E9	V-POT EXT9	
E10P	V-POT EXT10 Push			E10	V-POT EXT10	
E11P	V-POT EXT11 Push			E11	V-POT EXT11	
E12P	V-POT EXT12 Push			E12	V-POT EXT12	
E13P	V-POT EXT13 Push			E13	V-POT EXT13	
E14P	V-POT EXT14 Push			E14	V-POT EXT14	
E15P	V-POT EXT15 Push			E15	V-POT EXT15	
E16P	V-POT EXT16 Push			E16	V-POT EXT16	
				JOG	JOG WHEEL	B0, 3C, 01/41

## Appendix: MCU [DAW REMOTE MCU] commands list

OSC	MCU action	MIDI (port 4)
M1	V-POT M1	B0, 10, 01/41
M2	V-POT M2	B0, 11, 01/41
M3	V-POT M3	B0, 12, 01/41
M4	V-POT M4	B0, 13, 01/41
M5	V-POT M5	B0, 14, 01/41
M6	V-POT M6	B0, 15, 01/41
M7	V-POT M7	B0, 16, 01/41
M8	V-POT M8	B0, 17, 01/41
E1	V-POT EXT1	
E2	V-POT EXT2	
E3	V-POT EXT3	
E4	V-POT EXT4	
E5	V-POT EXT5	
E6	V-POT EXT6	
E7	V-POT EXT7	
E8	V-POT EXT8	
E9	V-POT EXT9	
E10	V-POT EXT10	
E11	V-POT EXT11	
E12	V-POT EXT12	
E13	V-POT EXT13	
E14	V-POT EXT14	
E15	V-POT EXT15	
E16	V-POT EXT16	
JOG	JOG WHEEL	B0, 3C, 01/41

## Appendix: WING Snapshot and JSON Data Structure:

A WING snapshot file (also called Snapfile when saved to a file) is organized as a collection of classes, sub-classes and objects regrouping attributes and values in logical groups. These can be represented as a hierarchical tree. A JSON<sup>110</sup> notation is used to describe and store the hierarchical tree.

A complete WING default snapfile is close to 800000 bytes and 33895 lines, containing a rather complex hierarchical list of more than 30000 object identifiers [WING parameters] and their associated values. A WING snapfile does not contain read-only objects; i.e. there are more parameters available than the ones listed/saved in a snapfile!

### Wing Snapfile

A snapfile is divided in sections as shown below:

```
{
  "type": "snapshot.9",
  "creator_fw": "2.1-117-gbfb74b95:develop",
  "creator_sn": "NO_SERIAL",
  "creator_model": "wing",
  "creator_version": "SX45-XU2",
  "creator_name": "HMS-01",
  "created": "2024-08-02 12:58:09",
  "active_show": "",
  "active_scene": "I:/FOLDER 1/SC0-NEW.snap",
  "ae_data": {
  "ce_data": {
  "ae_globals": {
  "ce_globals": {
  "scopes": {
  "updated": "2024-08-02 13:05:34"
}
```

ae\_data and ce\_data are representing WING Audio engine and Console Engine data  
ae\_globals and ce\_globals consist of global data affecting WING Audio and Console Engines

### Description

**description:** This small section contains (as its name suggest) a description for the snapshot, including name, and elements corresponding to the WING that generated the snapshot. “created” lists the date and time of the creation of the snapfile, while “updated” will retain the date and time of the most recent update made to the file.

```
"type": string, snapshot signature/version
"creator_fw": string, FW used when creating the snapshot
"creator_sn": string, Serial number of the WING the snapshot was created with
"creator_model": string, Model of console
"creator_name": string, Name given to the console
"created": string, date time,
"active_show": string, name of the currently opened show file
"active_scene": string, name of the current, active scene
"updated": string, date time,
```

---

<sup>110</sup> JavaScript Object Notation: an efficient way to represent structured objects. Also used as a data-interchange format.

## scopes

**scopes:** A large set of *Boolean* { '+', ' '} values to list what has been 'marked' at snapshot time. This can be used as a reminder of the initial purpose of the snapshot.

The scopes class contains the following objects:

*ch, aux, bus, main, mtx, dca, mute, fx, source, output, area, custom, setup, contents, mainsend, bussend;*

For example:

```
"scopes": {
  "ch": "+++++",
  "aux": "+++++",
  "bus": "+++++",
  "main": "++++",
  "mtx": "+++++",
  "dca": "+++++",
  "mute": "+++++",
  "fx": "+++++",
  "source": {
    "LCL": "+++++",
    "AUX": "+++++",
    "A": "+++++",
    "B": "+++++",
    "C": "+++++",
    "SC": "+++++",
    "USB": "+++++",
    "CRD": "+++++",
    "MOD": "+++++",
    "PLAY": "++++",
    "AES": "++",
    "USR": "+++++",
    "OSC": "++"
  },
  "output": {
    "LCL": "+++++",
    "AUX": "+++++",
    "A": "+++++",
    "B": "+++++",
    "C": "+++++",
    "SC": "+++++",
    "USB": "+++++",
    "CRD": "+++++",
    "MOD": "+++++",
    "REC": "++++",
    "AES": "++"
  },
  "area": {
    "LEFT": "+++++",
    "CENTER": "+++++",
    "RIGHT": "+++++"
  },
  "custom": "+++++",
  "setup": "++++",
  "contents": "+++++",
  "mainsend": "++++",
  "bussend": "+++++"
}
```

Scopes are not elements that can be programmatically changed. They are only set at snapshot time using the console main LCD. As mentioned above, they are optionally saved at save time to notify what was targeted for save/update.

## ae\_data

**ae\_data** stands for “Audio Engine”, and regroups a rather large set of attributes and values aimed at registering all main settings of the WING audio engine, such as Routing, Channel EQ settings, FX parameter values, etc., as shown in the figure below:

```
"ae_data": {
  "cfg": {
  "io": {
  "ch": {
  "aux": {
  "bus": {
  "main": {
  "mtx": {
  "dca": {
  "mgrp": {
  "fx": {
  "cards": {
  "play": {
  "rec": {
},
```

Expanding one (or any) of the blocks of parameters listed above will provide the respective WING parameters of that block, along with their value(s). Understanding what parameters are present in each block is a good way to better grasp and understand the vast range of capabilities WING offers. It is also a good way to envision the parameter list one can get and set using **wapi** (described earlier in this document) as the **JSON** structure parameters matches the tokens used by the API for **wapi get()** and **set()** functions.

Indeed, all tokens related to the audio engine can be directly coded from the **JSON** description, for example, the C-like token notation for the **JSON** *cfg.mon.1.pan* element is named **CFG\_MON\_1\_PAN**.

We show in the following pages, the contents of the **JSON** tree structure after a console reset, so only default values are listed. In order to reduce the number of pages the **JSON** structure description would take; the following notation is used:

**“abc”: {}**, means that **“abc”** uses the same structure definition as the previous member in the **JSON** file, and:

**“2”:{ }..“n”:** {}, means that objects **“2”** to **“n”** use the same structure definition as the previous member in the **JSON** file.

```
"ae_data": {
  "cfg": {
    "mainlink": "OFF",
    "dcamgrp": true,
    "mon": {
      "1": {
        "inv": false,
        "pan": 0,
        "wid": 100,
        "eq": {
          "on": false,
          "lsg": 0,
          "lsf": 60.13883591,
          "1g": 0,
          "1f": 129.8763428,
          "1q": 1.995881796,
          "2g": 0,
          "2f": 299.2471619,
          "2q": 1.995881796,
```

```

    "3g": 0,
    "3f": 699.4875488,
    "3q": 1.995881796,
    "4g": 0,
    "4f": 1499.78833,
    "4q": 1.995881796,
    "5g": 0,
    "5f": 2992.470947,
    "5q": 1.995881796,
    "6g": 0,
    "6f": 6013.883789,
    "6q": 1.995881796,
    "hsg": 0,
    "hsf": 11999.27344
  },
  "lim": 0,
  "dly": {
    "on": false,
    "m": 0.100000001
  },
  "dim": 20,
  "pflDIM": 12,
  "eqbdtrim": 0,
  "srcLvl": 0,
  "srcmix": -144,
  "src": "MAIN.1",
  "tags": ""
},
"2": {},
"solo": {
  "mode": "LIVE",
  "mon": "PH",
  "mute": false,
  "chtap": "PFL",
  "bustap": "AFL",
  "maintap": "PFL",
  "mtxtap": "PFL",
  "srcsolo": "OFF"
},
"rta": {
  "rtasrc": 0,
  "rtatap": "IN",
  "rtadecay": "MED",
  "rtadet": "PEAK",
  "rtarange": 30,
  "rtagain": 0,
  "rtaauto": true,
  "eqdecay": "MED",
  "eqdet": "PEAK",
  "eqrange": 30,
  "eqgain": 0,
  "eqauto": true
},
"mtr": {
  "scopesrc": 0,
  "scopetap": "IN",
  "mtrsfc": {
    "in": "PRE",
    "bus": "POST",
    "main": "POST",
    "mtx": "POST",
    "dca": "PRE"
  },
  "mtrpage": {
    "in": "PRE",
    "bus": "POST",

```

```

    "main": "POST",
    "mtx": "POST",
    "dca": "PRE"
  },
  "mainmtr": "MAIN.1",
  "mainpos": "AUTO"
},
"talk": {
  "assign": "OFF",
  "A": {
    "mode": "AUTO",
    "mondim": 0,
    "busdim": 0,
    "indiv": false,
    "B1": false,
    "B2": false,
    "B3": false,
    "B4": false,
    "B5": false,
    "B6": false,
    "B7": false,
    "B8": false,
    "B9": false,
    "B10": false,
    "B11": false,
    "B12": false,
    "B13": false,
    "B14": false,
    "B15": false,
    "B16": false,
    "MX1": false,
    "MX2": false,
    "MX3": false,
    "MX4": false,
    "MX5": false,
    "MX6": false,
    "MX7": false,
    "MX8": false,
    "M1": false,
    "M2": false,
    "M3": false,
    "M4": false
  },
  "B": {},
  "amix": {
    "x": true,
    "y": true
  }
},
"io": {
  "altsw": false,
  "autoaltovr": true,
  "in": {
    "LCL": {
      "1": {
        "mode": "M",
        "g": 0,
        "vph": false,
        "mute": false,
        "pol": false,
        "col": 1,
        "name": "",
        "icon": 1,
        "tags": "",
        "rmt": "OFF",
        "rcvc": false
      }
    }
  }
}

```



```

    },
    "2".."24": {}
  },
  "AUX": {
    "1": {
      "mode": "M",
      "mute": false,
      "pol": false,
      "col": 1,
      "name": "",
      "icon": 2,
      "tags": ""
    },
    "2".."8": {}
  },
  "A": {
    "1": {
      "mode": "M",
      "g": 0,
      "vph": false,
      "mute": false,
      "pol": false,
      "col": 1,
      "name": "",
      "icon": 0,
      "tags": "",
      "rmt": "OFF",
      "rcvc": false
    },
    "2".."48": {}
  },
  "B".."C": {}
},
"SC": {
  "1": {
    "mode": "M",
    "mute": false,
    "pol": false,
    "col": 1,
    "name": "",
    "icon": 0,
    "tags": ""
  },
  "2".."32": {}
},
"USB": {
  "1": {
    "mode": "ST",
    "mute": false,
    "pol": false,
    "col": 8,
    "name": "USB 1/2",
    "icon": 605,
    "tags": ""
  },
  "2": .."48": {}
},
"CRD": {
  "1": {
    "mode": "M",
    "mute": false,
    "pol": false,
    "col": 1,
    "name": "",
    "icon": 0,
    "tags": ""
  }
}

```

```

    },
    "2".."64": {}
  },
  "MOD": {
    "1": {
      "mode": "M",
      "mute": false,
      "pol": false,
      "col": 1,
      "name": "",
      "icon": 0,
      "tags": ""
    },
    "2".."64": {}
  },
  "PLAY": {
    "1": {
      "mode": "ST",
      "mute": false,
      "pol": false,
      "col": 8,
      "name": "2TR",
      "icon": 608,
      "tags": ""
    },
    "2".."4": {}
  },
  "AES": {
    "1": {
      "mode": "M",
      "mute": false,
      "pol": false,
      "col": 1,
      "name": "",
      "icon": 0,
      "tags": ""
    },
    "2": {}
  },
  "USR": {
    "1": {
      "mode": "M",
      "mute": false,
      "pol": false,
      "col": 1,
      "name": "",
      "icon": 0,
      "tags": "",
      "user": {
        "grp": "OFF",
        "in": 1,
        "tap": "PRE",
        "lr": "L+R"
      }
    },
    "2".. "48": {}
  },
  "OSC": {
    "1": {
      "mode": "M",
      "mute": false,
      "col": 1,
      "name": "",
      "icon": 0,
      "tags": "",
      "osc": {

```

```

        "lvl": -6,
        "mode": "SINE",
        "f": 999.9920044
    }
},
"2": {}
}
},
"out": {
    "LCL": {
        "1": {
            "grp": "BUS",
            "in": 1
        },
        "2".."8": {}
    },
    "AUX": {
        "1": {
            "grp": "OFF",
            "in": 1
        },
        "2".."8": {}
    },
    "A": {
        "1": {
            "grp": "OFF",
            "in": 1
        },
        "2".."48": {}
    },
    "B".."C": {}
},
"SC": {
    "1": {
        "grp": "OFF",
        "in": 1
    },
    "2".."32": {}
},
"USB": {
    "1": {
        "grp": "OFF",
        "in": 1
    },
    "2".."48": {}
},
"CRD": {
    "1": {
        "grp": "OFF",
        "in": 1
    },
    "2".."64": {}
},
"MOD": {
    "1": {
        "grp": "OFF",
        "in": 1
    },
    "2".."64": {}
},
"REC": {
    "1": {
        "grp": "OFF",
        "in": 1
    },
},

```

```

    "2".. "4": {}
  },
  "AES": {
    "1": {
      "grp": "OFF",
      "in": 1
    },
    "2": {}
  }
},
"ch": {
  "1": {
    "in": {
      "set": {
        "srcauto": false,
        "altsrc": false,
        "inv": false,
        "trim": 0,
        "bal": 0,
        "dlymode": "M",
        "dly": 0.100000001,
        "dlyon": false
      },
      "conn": {
        "grp": "LCL",
        "in": 1,
        "altgrp": "OFF",
        "altin": 1
      }
    },
    "flt": {
      "lc": false,
      "lcf": 100.2374573,
      "hc": false,
      "hcf": 10018.26074,
      "tf": false,
      "mdl": "TILT",
      "tilt": 0
    },
    "clink": true,
    "col": 1,
    "name": "",
    "icon": 0,
    "led": true,
    "mute": false,
    "fdr": -144,
    "pan": 0,
    "wid": 100,
    "solosafe": false,
    "mon": "A",
    "proc": "GEDI",
    "ptap": "5",
    "peq": {
      "on": false,
      "1g": 0,
      "1f": 99.68543243,
      "1q": 0.997970223,
      "2g": 0,
      "2f": 999.2504883,
      "2q": 0.997970223,
      "3g": 0,
      "3f": 10016.52734,
      "3q": 0.997970223
    },
    "gate": {

```

```

    "on": false,
    "mdl": "GATE",
    "thr": -40,
    "range": 40,
    "att": 10,
    "hld": 10,
    "rel": 199.4042816,
    "acc": 0,
    "ratio": "1:3"
  },
  "gatesc": {
    "type": "OFF",
    "f": 1002.37439,
    "q": 1.995881796,
    "src": "SELF",
    "tap": "IN"
  },
  "eq": {
    "on": false,
    "mdl": "STD",
    "mix": 100,
    "lg": 0,
    "lf": 80.19641876,
    "lq": 0.997970223,
    "leq": "SHV",
    "1g": 0,
    "1f": 200,
    "1q": 0.997970223,
    "2g": 0,
    "2f": 601.3883667,
    "2q": 0.997970223,
    "3g": 0,
    "3f": 1499.78833,
    "3q": 0.997970223,
    "4g": 0,
    "4f": 3990.524414,
    "4q": 0.997970223,
    "hg": 0,
    "hf": 11999.27539,
    "hq": 0.997970223,
    "heq": "SHV"
  },
  "dyn": {
    "on": false,
    "mdl": "COMP",
    "mix": 100,
    "gain": 0,
    "thr": -10,
    "ratio": 3,
    "knee": 3,
    "det": "RMS",
    "att": 50,
    "hld": 20,
    "rel": 152.5651855,
    "env": "LOG",
    "auto": true
  },
  "dynxo": {
    "depth": 6,
    "type": "OFF",
    "f": 1002.37439
  },
  "dynsc": {
    "type": "OFF",
    "f": 1002.37439,
    "q": 1.995881796,

```

```

    "src": "SELF",
    "tap": "IN"
  },
  "preins": {
    "on": false,
    "ins": "NONE"
  },
  "main": {
    "1": {
      "on": true,
      "lvl": 0,
      "pre": false
    },
    "2".."4": {}
  },
  "send": {
    "1": {
      "on": false,
      "lvl": -144,
      "pon": false,
      "ind": false,
      "mode": "PRE",
      "plink": false,
      "pan": 0
    },
    "2".."16": {},
    "MX1": {
      "on": false,
      "lvl": -144,
      "pon": false,
      "ind": false,
      "mode": "PRE",
      "plink": false,
      "pan": 0
    },
    "MX2".."MX8": {}
  },
  "tapwid": 100,
  "postins": {
    "on": false,
    "mode": "FX",
    "ins": "NONE",
    "w": 0
  },
  "tags": ""
},
"2".."40": {}
},
"aux": {
  "1": {
    "in": {
      "set": {
        "srcauto": false,
        "altsrc": false,
        "inv": false,
        "trim": 0,
        "bal": 0,
        "dlymode": "M",
        "dly": 0.100000001,
        "dlyon": false
      },
      "conn": {
        "grp": "USB",
        "in": 1,
        "altgrp": "OFF",
        "altin": 1
      }
    }
  }
}

```

```

    }
  },
  "clink": true,
  "col": 1,
  "name": "2TR",
  "icon": 0,
  "led": true,
  "mute": false,
  "fdr": -144,
  "pan": 0,
  "wid": 100,
  "solosafe": false,
  "mon": "A",
  "eq": {
    "on": false,
    "mdl": "STD",
    "mix": 100,
    "lg": 0,
    "lf": 80.19641876,
    "lq": 0.997970223,
    "leq": "SHV",
    "1g": 0,
    "1f": 200,
    "1q": 0.997970223,
    "2g": 0,
    "2f": 601.3883667,
    "2q": 0.997970223,
    "3g": 0,
    "3f": 1499.78833,
    "3q": 0.997970223,
    "4g": 0,
    "4f": 3990.524414,
    "4q": 0.997970223,
    "hg": 0,
    "hf": 11999.27539,
    "hq": 0.997970223,
    "heq": "SHV"
  },
  "dyn": {
    "on": false,
    "thr": -36,
    "depth": 12,
    "fast": false,
    "peak": false,
    "ingain": 40,
    "cpeak": 0,
    "cmode": "COMP"
  },
  "preins": {
    "on": false,
    "ins": "NONE"
  },
  "main": {
    "1": {
      "on": true,
      "lvl": 0,
      "pre": false
    },
    "2".."4": {}
  },
  "send": {
    "1": {
      "on": false,
      "lvl": -144,
      "pon": false,
      "ind": false,

```

```

    "mode": "PRE",
    "plink": false,
    "pan": 0
  },
  "2".."16": {},
  "MX1": {
    "on": false,
    "lvl": -144,
    "pon": false,
    "ind": false,
    "mode": "PRE",
    "plink": false,
    "pan": 0
  },
  "MX2".."MX8": {}
},
"tags": ""
},
"2".."8": {}
},
"bus": {
  "1": {
    "in": {
      "set": {
        "inv": false,
        "trim": 0,
        "bal": 0
      }
    }
  },
  "col": 10,
  "name": "",
  "icon": 0,
  "led": true,
  "busmono": false,
  "mute": false,
  "fdr": -144,
  "pan": 0,
  "wid": 100,
  "mon": "A",
  "busmode": "PRE",
  "eq": {
    "on": false,
    "mdl": "STD",
    "mix": 100,
    "lg": 0,
    "lf": 60.13883591,
    "lq": 0.997970223,
    "leq": "SHV",
    "1g": 0,
    "1f": 129.8763428,
    "1q": 0.997970223,
    "2g": 0,
    "2f": 299.2471619,
    "2q": 0.997970223,
    "3g": 0,
    "3f": 699.4875488,
    "3q": 0.997970223,
    "4g": 0,
    "4f": 1499.78833,
    "4q": 0.997970223,
    "5g": 0,
    "5f": 2992.470947,
    "5q": 0.997970223,
    "6g": 0,
    "6f": 6013.883789,
    "6q": 0.997970223,
  }
}

```



```

    "hg": 0,
    "hf": 11999.27539,
    "hq": 0.997970223,
    "heq": "SHV",
    "tilt": 0
  },
  "dyn": {
    "on": false,
    "mdl": "COMP",
    "mix": 100,
    "gain": 0,
    "thr": -10,
    "ratio": 3,
    "knee": 3,
    "det": "RMS",
    "att": 50,
    "hld": 20,
    "rel": 152.5651855,
    "env": "LOG",
    "auto": true
  },
  "dynxo": {
    "depth": 6,
    "type": "OFF",
    "f": 1002.37439
  },
  "dynsc": {
    "type": "OFF",
    "f": 1002.37439,
    "q": 1.995881796,
    "src": "SELF",
    "tap": "BUS"
  },
  "preins": {
    "on": false,
    "ins": "NONE"
  },
  "main": {
    "1": {
      "on": false,
      "lvl": 0,
      "pre": false
    },
    "2".."4": {}
  },
  "send": {
    "1": {
      "on": false,
      "lvl": -144,
      "pre": false
    },
    "2".."16": {},
    "MX1": {
      "on": false,
      "lvl": -144,
      "pre": false
    },
    "MX2".."MX8": {}
  },
  "postins": {
    "on": false,
    "ins": "NONE"
  },
  "dly": {
    "on": false,
    "mode": "M",

```

```

    "dly": 0.100000001
  },
  "tags": ""
},
"2".."16": {}
},
"main": {
  "1": {
    "in": {
      "set": {
        "inv": false,
        "trim": 0,
        "bal": 0
      }
    },
    "col": 1,
    "name": "",
    "icon": 0,
    "led": true,
    "busmono": false,
    "mute": false,
    "fdr": -144,
    "pan": 0,
    "wid": 100,
    "mon": "A",
    "eq": {
      "on": false,
      "mdl": "STD",
      "mix": 100,
      "lg": 0,
      "lf": 60.13883591,
      "lq": 0.997970223,
      "leq": "SHV",
      "1g": 0,
      "1f": 129.8763428,
      "1q": 0.997970223,
      "2g": 0,
      "2f": 299.2471619,
      "2q": 0.997970223,
      "3g": 0,
      "3f": 699.4875488,
      "3q": 0.997970223,
      "4g": 0,
      "4f": 1499.78833,
      "4q": 0.997970223,
      "5g": 0,
      "5f": 2992.470947,
      "5q": 0.997970223,
      "6g": 0,
      "6f": 6013.883789,
      "6q": 0.997970223,
      "hg": 0,
      "hf": 11999.27539,
      "hq": 0.997970223,
      "heq": "SHV",
      "tilt": 0
    },
    "dyn": {
      "on": false,
      "mdl": "COMP",
      "mix": 100,
      "gain": 0,
      "thr": -10,
      "ratio": 3,
      "knee": 3,
      "det": "RMS",

```

```

    "att": 50,
    "hld": 20,
    "rel": 152.5651855,
    "env": "LOG",
    "auto": true
  },
  "dynxo": {
    "depth": 6,
    "type": "OFF",
    "f": 1002.37439
  },
  "dynsc": {
    "type": "OFF",
    "f": 1002.37439,
    "q": 1.995881796,
    "src": "SELF",
    "tap": "BUS"
  },
  "preins": {
    "on": false,
    "ins": "NONE"
  },
  "send": {
    "MX1": {
      "on": false,
      "lvl": -144,
      "pre": false
    },
    "MX2".."MX8": {}
  },
  "postins": {
    "on": false,
    "ins": "NONE"
  },
  "dly": {
    "on": false,
    "mode": "M",
    "dly": 0.100000001
  },
  "tags": ""
},
"2".."4": {}
},
"mtx": {
  "1": {
    "in": {
      "set": {
        "inv": false,
        "trim": 0,
        "bal": 0
      }
    }
  },
  "dir": {
    "on": false,
    "lvl": -144,
    "inv": false,
    "in": "OFF"
  },
  "col": 1,
  "name": "",
  "icon": 0,
  "led": true,
  "busmono": false,
  "mute": false,
  "fdr": -144,
  "pan": 0,

```

```

"wid": 100,
"mon": "A",
"busmode": "PRE",
"eq": {
  "on": false,
  "mdl": "STD",
  "mix": 100,
  "lg": 0,
  "lf": 60.13883591,
  "lq": 0.997970223,
  "leq": "SHV",
  "1g": 0,
  "1f": 129.8763428,
  "1q": 0.997970223,
  "2g": 0,
  "2f": 299.2471619,
  "2q": 0.997970223,
  "3g": 0,
  "3f": 699.4875488,
  "3q": 0.997970223,
  "4g": 0,
  "4f": 1499.78833,
  "4q": 0.997970223,
  "5g": 0,
  "5f": 2992.470947,
  "5q": 0.997970223,
  "6g": 0,
  "6f": 6013.883789,
  "6q": 0.997970223,
  "hg": 0,
  "hf": 11999.27539,
  "hq": 0.997970223,
  "heq": "SHV",
  "tilt": 0
},
"dyn": {
  "on": false,
  "mdl": "COMP",
  "mix": 100,
  "gain": 0,
  "thr": -10,
  "ratio": 3,
  "knee": 3,
  "det": "RMS",
  "att": 50,
  "hld": 20,
  "rel": 152.5651855,
  "env": "LOG",
  "auto": true
},
"dynxo": {
  "depth": 6,
  "type": "OFF",
  "f": 1002.37439
},
"dynsc": {
  "type": "OFF",
  "f": 1002.37439,
  "q": 1.995881796,
  "src": "SELF",
  "tap": "BUS"
},
"preins": {
  "on": false,
  "ins": "NONE"
},

```

```

    "postins": {
      "on": false,
      "ins": "NONE"
    },
    "dly": {
      "on": false,
      "mode": "M",
      "dly": 0.100000001
    },
    "tags": ""
  },
  "2".."8": {}
},
"dca": {
  "1": {
    "name": "",
    "col": 1,
    "icon": 0,
    "led": false,
    "mute": false,
    "fdr": -144,
    "mon": "A"
  },
  "2".."16": {}
},
"mgrp": {
  "1": {
    "name": "MGRP.1",
    "mute": false
  },
  "2".."8": {}
},
"fx": {
  "1": {
    "mdl": "NONE",
    "fxmix": 100
  },
  "2".."16": {}
},
"cards": {
  "wlive": {
    "sdlink": "IND",
    "autoin": "OFF",
    "meters": true,
    "auto_stop": "KEEP",
    "auto_play": "KEEP",
    "auto_rec": "KEEP",
    "1": {
      "cfg": {
        "rectracks": "32",
        "playmode": "PLAY"
      }
    },
    "2": {}
  }
},
"play": {
  "repeat": true
},
"rec": {
  "resolution": "24",
  "channels": "2"
}
}

```

## ce\_data

**ce\_data** contains all JSON structure elements representing the “Control Engine” settings for WING. The `ce_data` class contains objects as shown below:

```
"ce_data": {  
  "cfg": {  
    "layer": {  
      "user": {  
        "gpio": {  
          "safes": {  
            "daw": {  
              "midi": {  
                "osc": {  
                  "lib": {}  
                }  
              }  
            }  
          }  
        }  
      }  
    }  
  },
```

Note that for ease of access and **programming** using the native interface or OSC remote protocol, the `ce_data` JSON tree structure is appended to the `ae_data` tree structure.

```
"ce_data": {  
  "cfg": {  
    "lights": {  
      "btns": 25,  
      "leds": 90,  
      "meters": 40,  
      "rgbleds": 25,  
      "chlclds": 60,  
      "chlcdctr": 50,  
      "chedit": 80,  
      "main": 80,  
      "glow": 0,  
      "patch": 0,  
      "lamp": 0  
    },  
    "rta": {  
      "homedisp": "1/3",  
      "homecol": "BL50",  
      "hometap": "IN",  
      "eqdisp": "1/4",  
      "eqcol": "BL75",  
      "cheqtap": "PRE",  
      "chflttap": "PRE"  
    },  
    "muteovr": true,  
    "soloexcl": true,  
    "selfsolo": true,  
    "solofsel": false,  
    "sof2solo": false,  
    "layerlinkl": false,  
    "layerlinkr": false,  
    "autoview": false,  
    "csctouch": true,  
    "autosel_L": false,  
    "autosel_C": false,  
    "autosel_R": false,  
    "fdrbanking": false,  
    "soffdr": "L/C",  
    "sofbutton": "AUTO",  
    "sofframe": true,  
    "sofmode": false,  
    "seidblclick": "BUSFX",  
    "usrmode": "BUS",
```

```

"mfdn": "MAIN.1",
"cscmode": "BUS",
"rackmode": "CH",
"busspill": false,
"mainspill": false,
"mtxspill": true,
"dcaspill": false,
"showfdr": true
},
"layer": {
  "L": {
    "sel": 1,
    "1": {
      "ofs": 0,
      "name": "CH1-12",
      "1": {
        "type": "CH",
        "i": 1,
        "dst": 1
      },
      "2".."24": {}
    },
    "2".."9": {}
  }
},
"C": {
  "sel": 1,
  "1": {
    "ofs": 0,
    "name": "DCA",
    "1": {
      "type": "DCA",
      "i": 1,
      "dst": 1
    },
    "2".."16": {}
  },
  "2".."9": {}
},
"R": {
  "sel": 1,
  "1": {
    "ofs": 0,
    "name": "MAIN",
    "1": {
      "type": "BUS",
      "i": 17,
      "dst": 1
    },
    "2".."16": {}
  },
  "2".."9": {}
},
"user": {
  "sel": 1,
  "mode": "MGRP",
  "cmode": "PAN",
  "gpio": {
    "1": {
      "bu": {
        "mode": "OFF",
        "name": "GPIO 1"
      }
    }
  },
  "2".."4": {}
}

```





```

"fx": " ",
"source": {
  "LCL": " ",
  "AUX": " ",
  "A": " ",
  "B": " ",
  "C": " ",
  "SC": " ",
  "USB": " ",
  "CRD": " ",
  "MOD": " ",
  "PLAY": " ",
  "AES": " ",
  "USR": " ",
  "OSC": " "
},
"output": {
  "LCL": " ",
  "AUX": " ",
  "A": " ",
  "B": " ",
  "C": " ",
  "SC": " ",
  "USB": " ",
  "CRD": " ",
  "MOD": " ",
  "REC": " ",
  "AES": " "
},
"area": {
  "LEFT": " ",
  "CENTER": " ",
  "RIGHT": " "
},
"custom": " ",
"setup": " "
},
"daw": {
  "on": false,
  "conn": "USB",
  "emul": "MCU",
  "config": "MSTR",
  "ccup": false,
  "disjog": true,
  "preset": "-"
},
"midi": {
  "enchctl": "OFF",
  "enfxctl": "OFF",
  "encustctl": "OFF",
  "ensysex": "OFF",
  "enmidicc": "OFF",
  "enscenes": "OFF",
  "enshowctl": "OFF",
  "enscenetx": "OFF"
},
"osc": {
  "ronly": false
},
"lib": {}
},

```

## globals

**ae\_globals** and **ce\_globals** contains JSON elements globally affecting the “audio” and “control” engines settings for WING. The objects are shown below:

```
"ae_globals": {
  "clkrate": 48000,
  "clksrc": "INT",
  "startmute": false,
  "usbacfg": "48/48",
  "sccfg": "AUTO",
  "harmt": {
    "a": false,
    "b": false,
    "c": false
  },
  "custsync": {
    "a": false,
    "b": false,
    "c": false
  }
},

"ce_globals": {
  "fdrsel": false,
  "fdrres": "AUTO",
  "fdrspd": "MED",
  "mousetchdis": false,
  "mousespd": 1.769999981,
  "tapflash": "ON",
  "srcdisp": true,
  "lockmtr": false,
  "cf_load": true,
  "cf_upd": true,
  "usewheel": true,
  "timefmt": "24H",
  "datefmt": "YMD"
},
```

## More JSON files

WING desk provides more JSON files. Indeed, JSON format is also used to save/store channel, library, and effect presets. These files are created as you save presets and libraries that help you setup your system faster down the road.