

TM024

BUILT-IN COMBINATION OVEN WITH HOT AIR AND MICROWAVE

COOK LIKE A GOD

THOR
K I T C H E N[®]

USE & CARE MANUAL

USE AND CARE MANUAL

BUILT-IN COMBINATION OVEN WITH HOT AIR AND MICROWAVE

TM024

THOR
K I T C H E N[®]

PRECAUTIONS TO AVOID POSSIBLE EXPOSURE TO EXCESSIVE MICROWAVE ENERGY

- (a) Do not attempt to operate this oven with the door open since this can result in harmful exposure to microwave energy. It is important not to break or tamper with the safety interlocks.
- (b) Do not place any object between the oven front face and the door or allow soil or cleaner residue to accumulate on sealing surfaces.
- (c) **WARNING:** If the door or door seals are damaged, the oven must not be operated until it has been repaired by a competent person.

ADDENDUM

If the apparatus is not maintained in a good state of cleanliness, its surface could be degraded and affect the lifespan of the apparatus and lead to a dangerous situation.

IMPORTANT SAFETY INSTRUCTIONS

IMPORTANT SAFETY INSTRUCTIONS WARNING

To reduce the risk of fire, electric shock, injury to persons or exposure to excessive microwave oven energy when using your appliance, follow basic precautions, including the following:

1. This appliance can be used by children aged from 8 years and above and persons with reduced physical, sensory or mental capabilities or lack of experience and knowledge if they have been given supervision or instruction concerning use of the appliance in a safe way and understand the hazards involved. Children shall not play with the appliance. Cleaning and user maintenance shall not be made by children without supervision.
2. Read and follow the specific: "PRE-CAUTIONS TO AVOID POSSIBLE EXPOSURE TO EXCESSIVE MICROWAVE ENERGY".
3. Keep the appliance and its cord out of reach of children less than 8 years.
4. If the supply cord is damaged, it must be replaced by the manufacturer, its service agent or similarly qualified persons in order to avoid a hazard. (For appliance with type Y attachment)
5. **WARNING:** It is hazardous for anyone other than a competent person to carry out any service or repair operation that involves the removal of a cover which gives protection against exposure to microwave energy.
6. **WARNING:** Liquids and other foods must not be heated in sealed containers since they are liable to explode.
7. This appliance can be used by children aged from 8 years and above and persons with reduced physical, sensory or instruction concerning use of the appliance in a safe way and understand the hazards involved. Children shall not play with the appliance. Cleaning and user maintenance shall not be made by children without supervision unless they are aged from 8 years and above and supervised.
8. When heating food in plastic or paper containers, keep an eye on the oven due to the possibility of ignition.
9. Only use utensils that are suitable for use in microwave ovens.
10. If smoke is emitted, switch off or unplug the appliance and keep the door closed in order to stifle any flames.
11. Microwave heating of beverages can result in delayed eruptive boiling, therefore care must be taken when handling the container.
12. The contents of feeding bottles and baby food jars shall be stirred or shaken and the temperature checked before consumption, in order to avoid burns.

13. Eggs in their shell and whole hard-boiled eggs should not be heated in microwave ovens since they may explode, even after microwave heating has ended.

14. The oven should be cleaned regularly and any food deposits removed.

15. Failure to maintain the oven in a clean condition could lead to deterioration of the surface that could adversely affect the life of the appliance and possibly result in a hazardous situation.

16. Only use the temperature probe recommended for this oven. (for ovens provided with a facility to use a temperature-sensing probe.)

17. The microwave oven must be operated with the decorative door open. (for ovens with a decorative door.)

18. This appliance is intended to be used in household and similar applications such as:

- staff kitchen areas in shops, offices and other working environments;
- by clients in hotels, motels and other residential type environments;
- farm houses;
- bed and breakfast type environments.

19. Care should be taken not to displace the turntable when removing containers from the appliance. (For fixed appliances and built-in appliances being used equal or higher than 900mm above the floor and having detachable turntables. But this is not applicable for appliances with horizontal bottom hinged door.)

20. The appliance shall not be cleaned with a steam cleaner .

21. WARNING: Ensure that the appliance is switched off before replacing the lamp to avoid the possibility of electric shock.

22. WARNING: Accessible parts may become hot during use. Young children should be kept away.

23. Steam cleaner is not to be used.

24. The microwave oven is intended for heating food and beverages. Drying of food or clothing and heating of warming pads, slippers, sponges, damp cloth and similar may lead to risk of injury, ignition or fire.

25. Surface of a storage drawer can get hot.

26. WARNING: The appliance and its accessible parts become hot during use. Care should be taken to avoid touching heating elements. Children less than 8 years of age shall be kept away unless continuously supervised.

27. During use the appliance becomes hot. Care should be taken to avoid touching heating elements inside the oven.

28. Metallic containers for food and beverages are not allowed during microwave cooking.

29. Do not use harsh abrasive cleaners or sharp metal scrapers to clean the oven door glass since they can scratch the surface, which may result in shattering of the glass.

30. The appliance is intended to be used built-in.

31. The appliance must not be installed behind a decorative door in order to avoid

overheating. (This is not applicable for appliances with decorative door.)

32. **WARNING:** When the appliance is operated in the combination mode, children should only use the oven under adult supervision due to the temperatures generated.

READ CAREFULLY AND KEEP FOR FUTURE REFERENCE

Causes of damage

Caution!

- Creation of sparks: Metal - e.g. a spoon in a glass - must be kept at least 2 cm from the oven walls and the inside of the door. Sparks could irreparably damage the glass on the inside of the door.
- Water in the hot cooking compartment: Never pour water into the hot cooking compartment. This will cause steam. The temperature change can cause damage.
- Moist food: Do not store moist food in the closed cooking compartment for long periods.
Do not use the appliance to store food. This can lead to corrosion.
- Cooling with the appliance door open: Only leave the cooking compartment to cool with the door closed. Do not trap anything in the appliance door. Even if the door is only slightly ajar, the fronts of adjacent units may be damaged over time.
- Heavily soiled seal: If the seal is very dirty, the appliance door will no longer close properly during operation. The fronts of adjacent units could be damaged. Always keep the seal clean.
- Operating the microwave without food: Operating the appliance without food in the cooking compartment may lead to overloading. Never switch on the appliance unless there is food in the cooking compartment. An exception to this rule is a short crockery test (see the section "Microwave, suitable crockery").
- Using the appliance door for standing on or placing objects on: Do not stand or place anything on the open appliance door. Do not place ovenware or accessories on the appliance door.
- Transporting the appliance: Do not carry or hold the appliance by the door handle. The door handle cannot support the weight of the appliance and could break.
- Microwave popcorn: Never set the microwave power too high. Use a power setting no higher than 600 watts. Always place the popcorn bag on a glass plate. The disc may jump if overloaded.
- Liquid that has boiled over must not be allowed to run through the turntable drive into the interior of the appliance. Monitor the cooking process. Choose a shorter cooking time initially, and increase the cooking time as required.
- The oven should be cleaned regularly and any food deposits removed since they may explode, even after microwave heating has ended.
- Failure to maintain the oven in a clean condition could lead to deterioration of the surface that could adversely affect the life of the appliance and possibly result in a hazardous situation.

Installation

Fitted units

- This appliance is only intended to be fully fitted in a kitchen.
- This appliance is not designed to be used as a tabletop appliance or inside a cupboard.
- The fitted cabinet must not have a back wall behind the appliance.
- A gap of at least 45 mm must be maintained between the wall and the base or back panel of the unit above.
- The fitted cabinet must have a ventilation opening of 250 cm² on the front. To achieve this, cut back the base panel or fit a ventilation grille.
- Ventilation slots and intakes must not be covered.
- The safe operation of this appliance can only be guaranteed if it has been installed in accordance with these installation instructions.
- The fitter is liable for any damage resulting from incorrect installation.
- The units into which the appliance is fitted must be heat-resistant up to 90 °C.

Installation dimensions

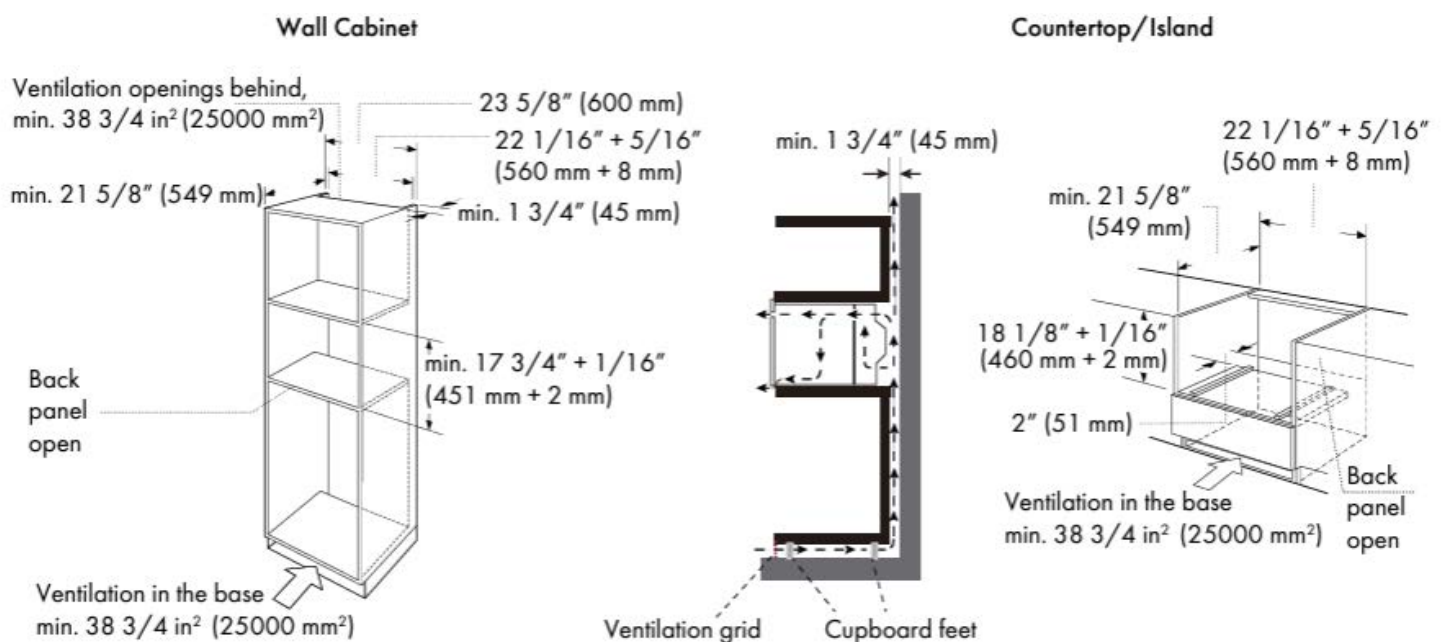

NOTE: There should be a gap above the oven.

Building in

- Do not hold or carry the appliance by the door handle. The door handle cannot hold the weight of the appliance and may break off.
1. Carefully push the microwave into the box, making sure that it is in the centre.
 2. Open the door and fasten the microwave with the screws that were supplied.

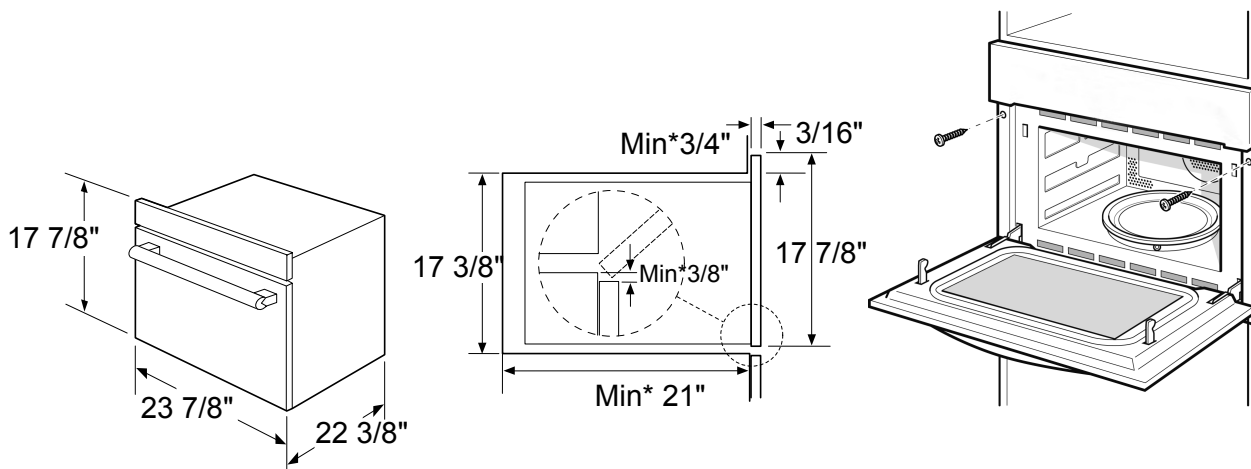

- Fully insert the appliance and centre it.
- Do not kink the connecting cable.
- Screw the appliance into place.
- The gap between the worktop and the appliance must not be closed by additional battens.

Important information

Electrical connection

The appliance is fitted with a plug and must only be connected to a properly installed earthed socket. Only a qualified electrician who takes the appropriate regulations into account may install the socket or replace the connecting cable. If the plug is no longer accessible following installation, an all-pole isolating switch must be present on the installation side with a contact gap of at least 3 mm. Contact protection must be ensured by the installation.

Fuse protection: see instructions for use-technical data.

Your new appliance

Use this section to familiarise yourself with your new appliance. The control panel and the individual operating controls are

explained. You will find information on the cooking compartment and the accessories.

Control panel



Touch keys and display

The touch keys are used to set the various additional functions. On the display, you can read the values that you have set.

Symbol	Function
AUTO DEFROST	Select Auto Defrost programs
FROZEN FOODS	Start cooking programs for frozen convenience foods
SENSOR COOK	Select Sensor Cook programs
SENSOR REHEAT	Select Sensor Reheat programs
POPCORN	Cook popcorn
BEVERAGE	Heat beverages
PIZZA	Select pizza programs
AUTO MENU	Select auto menu programs
BROIL HIGH-LOW	Set Broil modes (Hi/Lo)
POWER LEVEL	Set power level for microwave operation
CONVECTION	Select Bake Cook programs Select Roast Cook programs
PREHEAT	Select preheat programs
TEMP. WEIGHT	Set Temp. or weight of cooking
TIME	Set cooking time
PANEL LOCK	Activate/deactivate child lock
CLOCK	Set time of day
0 - 9	Use the number keys to enter customized values
START/ENTER +30 seconds	Confirm entered values/Start cooking mode Add 30 seconds
CLEAR/OFF	Clear entered value /turn appliance off

Parameter adjustment

Use the adjusting keys to set the parameters.

parameter	function
Auto menu	Select 8 automatic programmes.
Weight	Set the weight of cooking.
Time	Set the time of cooking.

Cooling fan

Your appliance has a cooling fan. The cooling fan switches on during operation. The hot air escapes above the door.

The cooling fan continues to run for a certain time after operation.

Caution!

Do not cover the ventilation slots. Otherwise, the appliance will overheat.

Notes

- The appliance remains cool during microwave operation. The cooling fan will still switch on. The fan may run on even when microwave operation has ended.
- Condensation may appear on the door window, interior walls and floor. This is normal and does not adversely affect microwave operation. Wipe away the condensation after cooking.

Accessories

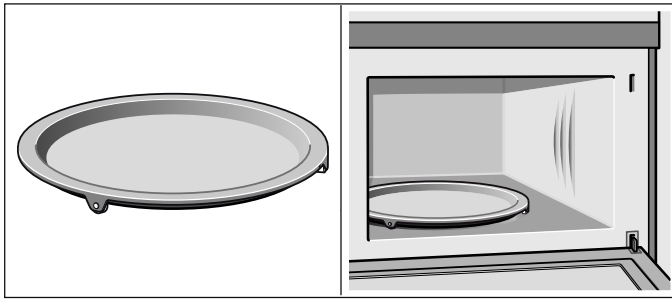

Turntable

As a surface for the wire rack.

Food which particularly requires a lot of heat from underneath can be prepared directly on the turntable.

The turntable can turn clockwise or anti-clockwise.

Place the turntable on the drive in the centre of the cooking compartment. Ensure that it is properly fitted.

- Never use the microwave without the turntable.
- The turntable can withstand max. 5 kg.
- The turntable must turn when using all types of heating.

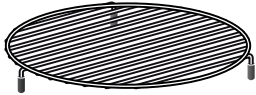

Lower wire rack

For the microwave and for baking and roasting in the oven.

Higher wire rack

For grilling, e.g. steaks, sausages and for toasting bread.

As a support for shallow dishes.

Note:

Type and quantity of accessories is subject to actual demand.

Before using the appliance for the first time

Here you will find everything you need to do before using your oven to prepare food for the first time. First read the section on *Safety information*.

Setting the clock

Once the appliance is connected, "12:00" will be displayed as the time of day. To set the correct time, proceed as follows:

1. Touch **Clock**.
2. Enter the correct time using the number keys.
Example: To set the clock to 12:41 type in 1 2 4 1.
3. Touch **Start/Enter** to confirm.
+30 seconds

Heating up the oven

To remove the new oven smell, heat up the appliance when it is empty and closed. One hour with Convection at 350° F (180 °C) is ideal. Ensure that no packaging remnants have been left in the oven cavity.

1. Touch **Convection** once to enter bake mode.
2. Enter the numbers 3 5 0 with the number keys.
3. Touch **TEMP./WEIGHT** to adjust cooking time.
4. Enter the numbers 60 with the number keys.
5. Touch **Start/Enter** to start cooking.
+30 seconds

The oven light turns on and the appliance starts heating.

Cleaning the accessories

Before you use the accessories for the first time, clean them thoroughly with hot soapy water and a soft dish cloth.

Setting the oven

There are various ways in which you can set your oven. Here we will explain how you can select the desired type of heating and temperature or grill setting. You can also select the oven cooking time for your dish. Please refer to the section on *Setting the time-setting options*.

Setting Convection mode

Example: roast 350°F for 20 minutes

1. Touch **Convection** twice to enter roast mode.
2. Enter the numbers 3 5 0 with the number keys.
3. Touch **TEMP./WEIGHT** to adjust cooking time.
4. Enter the numbers 2 0 with the number keys.
5. Touch **Start/Enter** to start cooking.
+30 seconds

Opening the oven door during operation

Operation is suspended. After closing the door, touch the **Start/Enter** key. Operation continues.
+30 seconds

Cancelling operation

Touch **Clear/Off** to cancel the active oven mode. The appliance turns off and the clock is displayed.

The cooling fans may continue to run for awhile and then switch off automatically.

Rapid Preheating

With rapid preheating, your oven reaches the set temperature particularly quickly.

To ensure an oven cooking result, only put your food in the cooking compartment when the preheating phase is complete.

1. Touch the **PREHEAT** key.
2. Enter the temperature setting with the number keys.
The input temperature should be within 100 to 450°F.

3. Touch the **Start/Enter** key.
+30 seconds

The oven begins to heat up.

The preheating process is complete

A signal sounds. Put your dish in the oven. Set the cooking mode you need.

Cancelling rapid preheating

During setting the rapid preheating function, touch the **Clear/Off** can cancel the function.

During rapid preheating, touch **Clear/Off** can cancel the function. Also you can open the door to cancel the function.

Note: Only when you can hear alarm and preheating icon is blinking you can open the door and put food inside.

The microwave

Microwaves are converted to heat in foodstuffs. The microwave can be used solo, i.e. on its own, or in combination with a different type of heating. You will find information about ovenware and how to set the microwave.

Note:

In the Expert Cooking Guide, you will find examples for defrosting, heating and cooking with the microwave oven.

Notes regarding ovenware

Suitable ovenware

Suitable dishes are heat-resistant ovenware made of glass, glass ceramic, porcelain, ceramic or heat-resistant plastic. These materials allow microwaves to pass through.

You can also use serving dishes. This saves you having to transfer food from one dish to another. You should only use ovenware with decorative gold or silver trim if the manufacturer guarantees that they are suitable for use in microwaves.

Unsuitable ovenware

Metal ovenware is unsuitable. Metal does not allow microwaves to pass through. Food in covered metal containers will remain cold.

Caution!

Creation of sparks: metal – e.g. a spoon in a glass – must be kept at least 2 cm from the oven walls and the inside of the door. Sparks could destroy the glass on the inside of the door.

Ovenware test

Do not switch on the microwave unless there is food inside. The following ovenware test is the only exception to this rule.

Perform the following test if you are unsure whether your ovenware is suitable for use in the microwave:

1. Heat the empty ovenware at maximum power for ½ to 1 minute.
2. Check the temperature occasionally during that time.

The ovenware should still be cold or warm to the touch.

The ovenware is unsuitable if it becomes hot or sparks are generated.

Microwave power settings

You can select from 10 different microwave power levels. If you do not set a power level, the microwave will automatically operate at the highest power level 10. The table below provides suggested power levels for various types of food that can be prepared in the microwave.

Power level	Microwave output	Use for
10	100%	Boiling water Cooking ground meat Making candy Cooking fresh fruit & vegetables Cooking fish & poultry Preheating browning dish Reheating beverages Cooking bacon slices
9	90%	Reheating meat slices quickly Saute onions, celery & green peppers
8	80%	All reheating Cooking scrambled eggs
7	70%	Cooking breads & cereal products Cooking cheese dishes Cooking muffins, brownies & cupcakes Cooking whole poultry
6	60%	Cooking pasta
5	50%	Cooking meat Cooking custard Cooking spare ribs, rib roast & sirloin roast

Power level	Microwave output	Use for
4	40%	Cooking less tender cuts of meat Reheating frozen packaged foods
3	30%	Thawing meat, poultry & seafood Cooking small quantities of food Finish cooking casseroles, stew & some sauces Melting chocolate
2	20%	Softening butter & cream cheese
1	10%	Softening ice cream Raise yeast dough

Setting the microwave

- Enter the desired cook time with the number keys. The timer display will fill in from right to left.
Example: To set a microwave time of 20 minutes and 30 seconds, enter the numbers 2 0 3 0.
- You can start microwave operation with the default power level 10 by touching **Start/Enter**,
-or- **Power Level**.
+30 seconds
you can set a different power level. Touch **Power Level**.
- Enter the desired power level using the number keys.
- Touch **Start/Enter** to start microwave operation.
+30 seconds
The microwave timer will start to count down.

Express cooking

- In waiting state, touch number keys 1 to 9 to start 100% microwave cooking in 1 to 9 minutes.
- If the door is closed, the oven will start to cook automatically after 2 seconds.

Change power level

You can change the power level at any time during microwave operation.

- Touch **Power Level**.
- Enter the desired power level with the number keys.
- Touch **Start/Enter**.
+30 seconds
Microwave operation continues with the new power level.

Opening the oven door during operation

Operation is suspended. After closing the door, touch the **Start/Enter** key. Operation continues.
+30 seconds

Cancelling operation

Touch **Clear/Off** to cancel the active oven mode. The appliance turns off and the clock is displayed.
The cooling fans may continue to run for awhile and then switch off automatically.

Speedy microwave cooking

Use the **Start/Enter** key to quick-start your
+30 seconds
microwave at the highest power level. You can touch the key repeatedly to increase the microwave time in increments of 30 seconds.
Touching this key during microwave operation will add 30 seconds to the remaining microwave time.

The cooking time has elapsed

A signal sounds. Microwave operation has finished.

Multi-stage cooking

- Enter the desired cook time with the number keys. The timer display will fill in from right to left.
- Touch **Power Level**.
- Enter the desired power level using the number keys.
- Touch **Power Level**.
- Enter the desired power level using the number keys.
- Touch **Start/Enter**.
+30 seconds
- Enter the desired cook time with the number keys.
- Touch **Start/Enter** to start microwave operation.
+30 seconds

The buzzer will sound 3 times when the first stage cooking is finished and enter to the second stage.

Automatic programmes

The automatic programmes enable you to prepare food very easily. You select the programme and enter the weight of your food. The automatic programme makes the optimum setting. You can choose from 9 programmes.

Always place the food in the cold cooking compartment.

Setting a programme

When you have selected a programme, set the oven. The temperature selector must be in the off position.

1. Touch **Auto menu** .
2. Touch **Auto menu** repeatedly to scroll through all Auto menu .
3. Touch **TEMP./WEIGHT** to adjust weight of food.
4. Touch **Start/Enter** to start cooking.
+30 seconds

Opening appliance door during operation

Opening the appliance door during operation will interrupt the current mode. Close the appliance door and then touch **Start/Enter** to resume operation.

+30 seconds

Cancel operation

Touch **Clear/Off** to cancel the active oven mode. The appliance turns off and the clock is displayed.

The cooling fans may continue to run for awhile and then switch off automatically.

Defrosting programmes

You can use the 2 defrosting programmes to defrost ground meat and meat pieces.

1. Touch **Auto Defrost** once or twice to choose "GROUND MEAT" or "MEAT PIECES".
2. Enter the weight of the food you want to defrost using the number keys.
3. Touch **Start/Enter** to start defrosting.
+30 seconds

Notes

■ Preparing food

Use food that has been frozen at -18 °C and stored in portion-sized quantities that are as thin as possible.

Take the food to be defrosted out of all packaging and weigh it. You need to know the weight to set the programme.

- Liquid will be produced when defrosting meat or poultry. Drain off this liquid when turning meat and poultry and under no circumstances use it for other purposes or allow it to come into contact with other foods.

Auto Menu

Program	Weight range	Food placement
1 - Chicken Breasts	0.5 - 3.0 lbs	Wire rack, facing down
2 - Chicken Thigh	0.5 - 3.0 lbs	Wire rack, facing down
3 - Whole Poultry	1.5 - 4.5 lbs	Turntable
4 - Beef Roast	0.5 - 3.25 lbs	Turntable
5 - Pork Tenderloin	1.0 - 3.0 lbs	Wire rack, facing down
6 - Pork Chops	0.5 - 3.0 lbs	Wire rack, facing down
7 - Meatloaf	1.0 - 3.25 lbs	Turntable
8 - Fish Fillets	0.5 - 2.0 lbs	Wire rack, facing down

■ Ovenware

Place the food in a microwaveable shallow dish, e.g. a china or glass plate, but do not cover.

- When defrosting chicken and chicken portions (d 01), an audible signal will sound on two occasions to indicate that the food should be turned.

■ Resting time

The defrosted food should be left to stand for an additional 10 to 30 minutes until it reaches an even temperature. Large pieces of meat require a longer standing time than smaller pieces. Flat pieces of meat and items made from minced meat should be separated from each other before leaving to stand.

After this time, you can continue to prepare the food, even though thick pieces of meat may still be frozen in the middle. The giblets can be removed from poultry at this point.

Programme no.	Defrost	Weight range in kg
1	Ground meat	0.50 - 2.00
2	Meat pieces	0.50 - 3.00

Popcorn

⚠ CAUTION

Do not leave oven unattended while popping corn. Popcorn may ignite and cause fire.

The popcorn feature lets you pop 3 different bag sizes of commercially packaged microwave popcorn. Use the following table to determine the setting to use:

Bag size	Touch Popcorn key
1.2 oz.	once
2.5 oz.	twice
3.5 oz.	3 times

Setting Popcorn mode

The appliance must be turned off.

1. Touch **Popcorn**. The cook time is displayed.
2. Touch **Popcorn** repeatedly or touch number key 1 to 3 to choose the desired weight.
3. Touch **Start/Enter**.
+30 seconds

The microwave timer starts counting down.

When the microwave time has elapsed, a beep will sound. The appliance turns off and the clock is displayed.

Beverage

The beverage feature heats 0.5 to 2 cups of a beverage. Use the table below to determine the setting to use.

Amount	Touch Beverage key
0.5 cups (about 4 oz.)	once
1 cup (about 8 oz.)	twice
1.5 cups (about 12 oz.)	3 times
2 cups (about 16 oz.)	4 times

Setting Beverage mode

1. Touch **Beverage**.
The cook time is displayed.
2. Touch **Beverage** repeatedly or touch number key 1 to 4 to choose the desired amount.
3. Touch **Start/Enter**.
+30 seconds

The microwave timer starts counting down.

When the microwave time has elapsed, a beep will sound. The appliance turns off and the clock is displayed.

Frozen Foods

Use the Frozen Foods feature to prepare frozen convenience foods, like chicken nuggets, french fries, fish sticks, using bottom heat and Convection. Place the food you want to cook directly on the metal tray turntable.

You can set a temperature range from 200 to 450° F (100 to 230°C).

Setting Frozen Foods

The appliance must be turned off.

1. Touch **Frozen Foods**.
2. You can change the temperature by using the number keys. You can enter a temperature between 200 and 450° F (100 - 230°C).
3. Touch **TEMP./WEIGHT** to adjust cooking time.
4. Touch **Start/Enter** to start cooking.
+30 seconds

Opening appliance door during operation

Opening the appliance door during operation will interrupt the current mode. When you close the appliance door, operation will be resumed.

Cancel operation

Touch **Clear/Off** to cancel the active oven mode. The appliance turns off and the clock is displayed.

The cooling fans may continue to run for awhile and then switch off automatically.

Pizza

You can use the Pizza mode to bake three different types of pizza:

Mode no.	Pizza type	Bake on
1	Frozen pizza	Metal tray
2	Fresh pizza	Metal tray
3	Microwave pizza	Ceramic tray

Pizza tips

- Check pizza before minimum time, pizza may cook faster compared to a traditional oven.
- For fresh pizza use a pizza paddle for sliding the pizza on and from the metal turntable.
- If using a pizza paddle, sprinkle the paddle liberally with cornmeal for ease in transferring the dough to the metal turntable.
- Maximum size is 12 inches for fresh and frozen pizzas.
- Avoid using a pizza stone as it can damage the oven.
- The metal turntable can be used for cutting pizza into slices. Remove the turntable from the oven after the pizza is baked.

Setting Pizza mode for fresh or frozen pizza

The appliance must be turned off.

You can set a temperature range from 375 to 450° F (190 to 230°C) for fresh and frozen pizza modes.

You can bake fresh or frozen pizza directly on the metal tray turntable.

1. Touch **Pizza**.
2. Touch **Pizza** repeatedly to scroll through all pizza modes.
3. Touch **Start/Enter**.
+30 seconds

4. You can change the temperature by using the number keys. Touch **Start/Enter** to confirm.

+30 seconds

The appliance starts preheating.

The set temperature is reached once the preheat bar has filled up completely and a beep sounds.

Opening appliance door during operation

Opening the appliance door during operation will interrupt the current mode. When you close the appliance door, operation will be resumed.

Setting Pizza mode for microwave pizza

Place the microwave pizza on the ceramic tray and put it in the oven following package directions.

1. Touch **Pizza**.
 2. Touch the number key 3 or touch **Pizza** repeatedly until MICROWAVE PIZZA is displayed.
 3. Touch **Start/Enter**.
- +30 seconds
4. Touch **Start/Enter** again. **sensing** and the microwave symbol light up on the display.
The appliance starts sensing.

When sensing is complete, a beep will sound and the calculated cook time will start to count down.

After the cook time has run out a beep will sound. The appliance turns off and the clock is displayed.

Note: Do not open the door during the sensing process, or the program will be cancelled.

Once the calculated cook time is displayed, you can open the door to stir, turn or rearrange the food. Touch **Start/Enter** to resume operation.

Opening appliance door during operation

Opening the appliance door during operation will interrupt the current mode. Close the appliance door and then touch **Start/Enter** to resume operation.

+30 seconds

Sensor cooking

You can select two sensor cooking modes. Sensor cooking allows you to cook many of your favorite foods without selecting cooking times and power levels. The microwave oven automatically determines the required cooking time for each food item.

For best results for cooking by sensor, follow these recommendations:

- Food cooked with the sensor system should start from normal storage temperature.
- Turntable tray, ceramic tray and outside of container should be dry.
- Foods should always be covered loosely with microwavable plastic wrap, wax paper or lid.
- Do not open the door or touch **Clear/Off** key during sensing time. When sensing time is over, the oven beeps once and the remaining cooking time will appear in the display. **At this time you can open the door to stir, turn or rearrange the food.**

Sensor Reheat

The Sensor Reheat feature lets you reheat dinner plates or casseroles (8-16 oz.) for your cooking convenience.

Setting Sensor Reheat

1. Touch **Sensor Reheat**.
 2. Touch **Start/Enter**.
- +30 seconds
- sensing** is displayed. The microwave operates during sensing.
3. When sensing is complete, a beep will sound and the calculated cook time will start to count down.

Note: Do not open the door during the sensing process, or the program will be cancelled.

Once the calculated cook time is displayed, you can open the door to stir, turn or rearrange the food. Touch **Start/Enter** to resume operation.

When sensor reheat is finished, a beep will sound and the appliance turns off.

Notes

- Cover with vented plastic wrap or wax paper.
- Reheat food on a microwavable dinner plate.

Reheat cooking suggestions

Food	Directions	Quantity
Dinner plate	Use only pre-cooked, refrigerated foods. Cover plate with vented plastic wrap or waxed paper, tucked under plate. If food is not hot enough after heating with the Reheat feature, continue heating using manual time and power level setting. Contents: <ul style="list-style-type: none"> • 3-4 oz. meat, poultry or fish (up to 6 oz. with bone) • 1/2 cup starch (potatoes, pasta, rice, etc.) • 1/2 cup of vegetables (about 3-4 oz.) 	1 serving (1 plate)
Casserole, Pasta	Cover plate with lid or vented plastic wrap. If food is not hot enough after heating with the Reheat feature, continue heating using manual time and power level setting. Stir foods once before serving. Contents: <ul style="list-style-type: none"> • Casserole: refrigerated foods (such as beef stew or lasagna) • Pasta: Canned spaghetti and ravioli, refrigerated foods 	1 to 4 servings

Sensor Cook

Sensor Cook allows you to cook many of your favorite foods without selecting cooking times and power levels. The microwave oven automatically determines the required cooking time for each food item.

Setting Sensor Cook

The appliance must be turned off.

Example: Set Sensor Cook for Ground Meat.

1. Touch **Sensor Cook**.
2. Select the desired program from the label at the oven cavity. For Ground Meat touch the number key 5.
-or-
Touch **Sensor Cook** repeatedly to scroll through all Sensor Cook modes.
3. Touch **Start/Enter**.
+30 seconds
The program will start sensing with the microwave operating.

Sensor Cook programs

Sensor Cook Program	Quantity	Cooking tips
1 - Baked Potato	1 - 4 potatoes (8 - 32 oz.)	Pierce skin with a fork. Do not cover. After cooking, allow to stand wrapped in foil for 5 minutes.
2 - Ground Meat	8 - 24 oz. (0.5 - 1.5 lbs)	After cooking, allow to stand, covered, for 3 - 4 minutes.
3 - Fresh Vegetables	4 - 16 oz. (0.25 - 1 lbs)	No water is needed if vegetables have just been washed. Add 2 tablespoons water per 8 ounces of fresh vegetables.
4 - Fish/Seafood	8 - 20 oz. (0.5 - 1.25 lbs)	Roll thin edges underneath. Arrange in a ring around microwaveable dish.
5 - Frozen Entrees	10 - 20 oz.	Follow package instructions for venting, cutting plastic film, etc.

When sensing is complete, a beep will sound and the calculated cook time will start to count down.

Note: Do not open the door during the sensing process, or the program will be cancelled.

Once the calculated cook time is displayed, you can open the door to stir, turn or rearrange the food. Touch **Start/Enter** to resume operation.

When sensor cook is finished a beep will sound and the appliance turns off.

Opening appliance door during operation

Opening the appliance door during operation will interrupt the current mode. Close the appliance door and then touch **Start/Enter** to resume operation.
+30 seconds

Cancel operation



Touch **Clear/Off** to cancel the active oven mode. The appliance turns off and the clock is displayed.

The cooling fans may continue to run for awhile and then switch off automatically.

Broil

The Broil feature uses intense heat radiated from the upper element.

You can set two intensity levels:

- Broil high 
- Broil low 

Setting Broil mode

The appliance must be turned off.

1. Touch **Broil HIGH-LOW** .
2. Touch **Broil** again, to change to Broil low mode.
3. Enter the desired cooking time with the number keys.
4. Touch **Start/Enter** to start operation.
+30 seconds

Note: Always use a broil pan when cooking in Broil mode (see optional accessories).

Opening appliance door during operation

Opening the appliance door during operation will interrupt the current mode. When you close the appliance door, operation will be resumed.

Cancel operation

Touch **Clear/Off** to cancel the active oven mode. The appliance turns off and the clock is displayed.

The cooling fans may continue to run for awhile and then switch off automatically.

Setting the time-setting options

Your oven has various time-setting options. You can use the **Clock** key to call up the menu and switch between the individual functions.

Setting the cooking time

The cooking time for your meal can be set on the oven. When the cooking time has elapsed, the oven switches itself off automatically. This means that you do not have to interrupt other work to switch off the oven. The cooking time cannot be accidentally exceeded.

The oven starts. The cooking time counts down in the display.

The cooking time has elapsed

An audible signal sounds. The oven stops heating.

Setting the clock

1. Touch **Clock**.
2. Enter the correct time using the number keys.
Example: To set the clock to 12:41 type in 1 2 4 1.
3. Touch **Start/Enter** to confirm.
+30 seconds

Changing the clock

1. Touch **Clock** in waiting state.
The actual time disappears and then the time will blink in the display.
2. Enter the correct time using the number keys.
3. Touch **Start/Enter** to confirm.
+30 seconds

Childproof lock

The oven has a childproof lock to prevent children switching it on accidentally.

The oven will not react to any settings. The timer and clock can also be set when the childproof lock has been switched on.

Switching on the childproof lock

Requirement: No cooking time should be set .

Touch and hold the **Panel lock** key for approx. 3 seconds.

The lock symbol appears in the display. The childproof lock is activated.

Switching off the childproof lock

Touch and hold the **Panel lock** key for approx. 3 seconds.

The lock symbol on the display goes out. The childproof lock is deactivated.

Childproof lock with other cooking operations

When other cooking programmes have been set, the childproof lock is not operational.

Care and cleaning

With careful care and cleaning your microwave oven will retain its looks and remain good order. We will explain here how you should care for and clean your appliance correctly.

⚠ Risk of electric shock.!

Penetrating moisture may cause an electric shock. Do not use any high-pressure cleaners or steam cleaners.

⚠ Risk of burns!

Never clean the appliance immediately after switching off. Let the appliance cool down.

⚠ Risk of serious damage to health!

Microwave energy may escape if the cooking compartment door or the door seal is damaged. Never use the appliance if the cooking compartment door or the door seal is damaged. Contact the after-sales service.

Notes

- Slight differences in colour on the front of the appliance are caused by the use of different materials, such as glass, plastic and metal.
- Shadows on the door panel which look like streaks, are caused by reflections made by the oven light.
- Unpleasant odours, e.g. after fish has been prepared, can be removed very easily. Add a few drops of lemon juice to a cup of water. Place a spoon into the container as well, to prevent delayed boiling. Heat the water for 1 to 2 minutes at maximum microwave power.

Cleaning agents

To ensure that the different surfaces are not damaged by using the wrong cleaning agent, observe the information in the table. Do not use

- sharp or abrasive cleaning agents,
- metal or glass scrapers to clean the glass in the appliance door.
- metal or glass scrapers to clean the door seal,
- hard scouring pads and sponges,
- cleaning agents with high concentrations of alcohol.

Wash new sponge cloths thoroughly before use.

Allow all surfaces to dry thoroughly before using the appliance again.

Area	Cleaning agents
Appliance front	Hot soapy water: Clean with a dish cloth and dry with a soft cloth. Do not use glass cleaners or metal or glass scrapers for cleaning.
Appliance front with stainless steel	Hot soapy water: Clean with a dish cloth and dry with a soft cloth. Remove flecks of limescale, grease, starch and albumin (e.g. egg white) immediately. Corrosion can form under such residues. Special stainless steel cleaning agents can be obtained from the after-sales service or from specialist shops. Do not use glass cleaners or metal or glass scrapers for cleaning.
Cooking compartment	Hot soapy water or a vinegar solution: Clean with a dish cloth and dry with a soft cloth. If the oven is very dirty: Do not use oven spray or other aggressive oven cleaners or abrasive materials. Scouring pads, rough sponges and pan cleaners are also unsuitable. These items scratch the surface. Allow the interior surfaces to dry thoroughly.
Recess in cooking compartment	Damp cloth: Ensure that no water seeps through the turntable drive into the appliance interior.
Wire racks	Hot soapy water: Clean using stainless steel cleaning agent or in the dishwasher.
Door panels	Glass cleaner: Clean with a dish cloth. Do not use a glass scraper.
Seal	Hot soapy water: Clean with a dish cloth, do not scour. Do not use a metal or glass scraper for cleaning.

Technical data

Rated Voltage	120 V~, 60 Hz
Maximum Power	3400W
Rated Output Power(Microwave)	1000W
Oven Capacity	44L
Turntable Diameter	∅ 360mm
External Dimensions Without handle	595(W) × 568(D) × 454(H)mm
Net Weight	Approx. 35.36kg

Malfunction table







Malfunctions often have simple explanations. Please refer to the malfunction table before calling the after-sales service.

If a meal does not turn out exactly as you wanted, refer to the Expert Cooking Guide section, where you will find plenty of cooking tips and tricks.

Risk of electric shock!

Incorrect repairs are dangerous. Repairs may only be carried out by one of our trained after-sales engineers.

Malfunction table

Problem	Possible cause	Remedy/information
The appliance does not work.	Faulty circuit breaker.	Look in the fuse box and check that the circuit breaker for the appliance is in working order.
	Plug not plugged in.	Plug in the plug.
	Power cut	Check whether the kitchen light works.
The appliance does not work.  appears in the display panel.	Childproof lock is active.	Deactivate the childproof lock (see section: Childproof lock).
 is in the display panel.	Power cut	Reset the clock.
The microwave does not switch on.	Door not fully closed.	Check whether food residue or debris is trapped in the door.
It takes longer than before for the food to heat up in the microwave	The selected microwave power level is too low.	Select a higher power level.
	A larger amount than usual has been placed in the appliance.	Double the amount = almost double the cooking time.
	The food was colder than usual.	Stir or turn the food during cooking.
Turntable grates or grinds.	Dirt or debris in the area around the turntable drive.	Clean the rollers under the turntable and the recess in the oven floor thoroughly.
A particular operating mode or power level cannot be set.	The temperature, power level or combined setting is not possible for this operating mode.	Choose permitted settings.
 appears in the display panel.	The thermal safety switch-off function has been activated.	Call the after-sales service.
 appears in the display panel.	The thermal safety switch-off function has been activated.	Call the after-sales service.
 appears in the display panel.	Moisture in the control panel.	Allow the control panel to dry.
 appears in the display panel.	Rapid heating has failed.	Call the after-sales service.

Acrylamide in foodstuffs

Which foods are affected?

Acrylamide is mainly produced in grain and potato products that are heated to high temperatures, such as potato crisps, chips,

toast, bread rolls, bread, fine baked goods (biscuits, gingerbread, cookies).

Tips for keeping acrylamide to a minimum when preparing food

General	Keep cooking times to a minimum. Cook meals until they are golden brown, but not too dark. Large, thick pieces of food contain less acrylamide.
Baking biscuits Oven chips	Max. 200 °C in Top/bottom heating or max. 180 °C in 3D hot air or hot air mode. Max. 190 °C in Top/bottom heating or max. 170 °C in 3D hot air or hot air mode. Egg white and egg yolk reduce the formation of acrylamide. Distribute thinly and evenly over the baking tray. Cook at least 400 g at once on a baking tray so that the chips do not dry out.

Energy and environment tips

Here you can find tips on how to save energy when baking and roasting and how to dispose of your appliance properly.

Saving energy

- Only preheat the oven if this is specified in the recipe or in the operating instruction tables.
- Use dark, black lacquered or enamelled baking tins. They absorb the heat particularly well.
- Open the oven door as infrequently as possible while you are cooking, baking or roasting.
- It is best to bake several cakes one after the other. The oven is still warm. This reduces the baking time for the second cake. You can also place two loaf tins next to each other.

- For longer cooking times, you can switch the oven off 10 minutes before the end of the cooking time and use the residual heat to finish cooking.

Environmentally-friendly disposal

Dispose of packaging in an environmentally-friendly manner.



This appliance complies with European Directive 2002/96/EC on Waste Electrical and Electronic Equipment (WEEE). The directive gives a framework for the collection and recycling of old appliances, which is valid across the EU.

Expert Cooking Guide

The charts can be used as a guide. Follow package or recipe directions.

Broil

Place pan of food on the wire rack with the recess facing up.

Food	Oven temperature	Cooking time (minutes)	Internal temperature	Cooking tip / Procedure
Hamburgers, ¾" to 1", medium	High	Side 1: 9 - 11 Side 2: 10 - 12	160°F (71°C)	Use pan that allows fat to drain away from the food. High fat meat causes more spattering.
Lamb chops, 1", medium	High	Side 1: 9 - 11 Side 2: 10 - 12	160°F (71°C)	Use pan that allows fat to drain away from the food. Slit fat to prevent curling.
Sausage, fresh	High	Side 1: 9 - 11 Side 2: 8 - 10	160°F (71°C)	Use pan that allows fat to drain away from the food.
Steaks, ¾" to 1", medium rare	High	Side 1: 9 - 11 Side 2: 10 - 12	145°F (63°C)	Use pan that allows fat to drain away from the food. Slit fat to prevent curling.
Steaks, ¾" to 1", medium	High	Side 1: 9 - 11 Side 2: 10 - 12	160°F (71°C)	Use pan that allows fat to drain away from the food. Slit fat to prevent curling.
Toasting bread	Low	3 - 5	-	Check at minimum time.
Top browning casseroles	Low	3 - 5	-	Use only metal or glass ceramic dishes such as Corning Ware®

Convection Broil

Place pans of food on the wire rack with the recess facing up.

Food	Oven temperature	Cooking time (minutes)	Internal temperature	Cooking tip / Procedure
Chicken breasts, bone-in	Low	Side 1: 9 - 11 Side 2: 10 - 12	170°F (76°C)	Start breast side down.
Fish filets, ¾" to 1"	Low	11 - 15	145°F (63°C)	No turning of fish. Turn thin ends under. Brush with olive oil or butter to prevent sticking.

Convection

Preheat the oven before adding foods. Once the oven is preheated, place the food in the oven quickly to minimize

loss of heat. Place pans of food on the wire rack with the recess facing down.

Food	Oven temperature	Cooking time (minutes)	Cooking tip / Procedure
Biscuits	350°F (175°C)	13 - 20	A dark or dull baking sheet will result in a browner, crisper crust.
Cake, 13"x9"	350°F (175°C)	23 - 28	For a tender, light golden brown crust, use light, shiny metal bakeware.
Cookies	350 - 375°F (175 - 190°C)	8 - 14	A dark or dull baking sheet will result in a browner, crisper crust.
Cornbread	425 - 450°F (220 - 230°C)	25 - 30	Use a square baking pan.
Cupcakes	350°F (175°C)	18 - 21	Ideal for ready-made mixes. Prepare according to package directions.
Dinner rolls	400°F (205°C)	12 - 18	Use with fresh or frozen dinner rolls.
Fresh fruit pie	375°F (190°C)	50 - 60	A dark or dull baking pie pan will result in a browner, crisper crust.
Muffins	400°F (205°C)	10 - 18	Ideal for ready-made mixes. Prepare according to package directions.
Roasted vegetables	425 - 450°F (220 - 230°C)	15 - 20	Use dark or dull metal pan. Stir once.
Shortcakes	450°F (230°C)	10 - 18	Best for individual shortcakes. Use dark coated pan.

Cooking eggs in your microwave

- Never cook eggs in the shell and never warm hard-cooked eggs in the shell; they can explode.
- Always pierce yolk on whole eggs to keep them from bursting.
- Cook eggs just until set; they will become tough if overcooked.
- Cooking scrambled eggs is safe.

Cooking vegetables in your microwave

- Vegetables should be washed just before cooking. Rarely is extra water needed. If dense vegetables such as potatoes or carrots are being cooked, add about ¼ cup of water.
- Small vegetables (sliced carrots, peas, lima beans, etc.) will cook faster than larger vegetables.
- Whole vegetables, such as potatoes, acorn squash or corn on the cob, should be arranged in a circle on the turntable before cooking. They will cook more evenly if turned over halfway through cooking.

- Always place vegetables like asparagus and broccoli with the stem ends pointing towards the edge of the dish and the tips toward the center.
- When cooking cut vegetables, always cover the dish with a lid or vented microwavable plastic wrap.
- Whole, unpeeled vegetables such as potatoes, sweet potatoes, squash, eggplant, etc., should have their skin pricked in several locations before cooking to prevent them from bursting.
- For more even cooking, stir or rearrange whole vegetables halfway through the cook time.
- Most of the time, the denser the food, the longer the required standing time. For example, a baked potato should stand for 5 minutes before serving, while a dish of peas may be served immediately.

Heating food

⚠ Risk of scalding!

There is a possibility of delayed boiling when a liquid is heated. This means that the liquid reaches boiling temperature without the usual steam bubbles rising to the surface. Even if the container only moves a little, the hot liquid can suddenly boil over and spatter. When heating liquids, always place a spoon in the container. This will prevent delayed boiling.

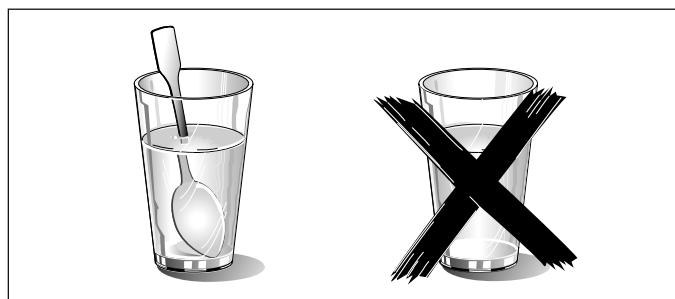

Cooking seafood in your microwave

Be sure to place fish on a microwave-safe roasting rack in a microwave-safe dish. Be sure to always cook fish until it flakes easily with a fork. Use a tight cover to steam

fish; a lighter cover of wax paper or paper towel provides less steaming. And be sure not to overcook fish; check it for doneness at a minimum cooking time before cooking longer.

Seafood	Power level	Cook time	Directions
Fish steaks up to 1½ lbs	medium high (7)	7–11 min. /lb	Arrange fish on roasting rack with meaty portions towards the outside of rack. Cover with wax paper. Turn over and rearrange halfway through cook time. Cook until fish flakes easily with fork. Let stand 3–5 mins.
Fish fillets up to 1½ lbs.	medium high (7)	7–11 min. /lb	Arrange fillets in a baking dish, turning any thin pieces under. Cover with wax paper. If over ½ inch thick, turn over and rearrange halfway through cook time. Cook until fish flakes easily with fork. Let stand 2–3 mins.
Shrimp up to 1½ lbs.	medium high (7)	7–11 min. /lb	Arrange shrimp in a baking dish without overlapping or layering. Cover with wax paper. Cook until firm and opaque, stirring 2 or 3 times. Let stand 5 mins.

Cleaning and Maintenance

▲ WARNING

Be sure the entire appliance has cooled and grease has solidified before attempting to clean any part of the appliance.

Cleaning Guide

- For best performance and for safety reasons, keep the oven clean inside and outside. Take special care to keep the inner door panel and oven front frame free of food and grease build-up.
- Never use abrasive scouring powder or pads on the microwave. Wipe the microwave oven inside and out

with a soft cloth and warm (not hot) mild detergent solution. Then rinse and wipe completely dry.

- Wipe spatters immediately with a wet paper towel, especially after cooking greasy foods like chicken or bacon.
- Clean your microwave oven weekly or more often, if needed.
- Never operate the microwave oven without food in the oven cavity, unless pre-heating with Convection, Pizza, Frozen Foods and Keep Warm mode; this can damage the magnetron tube or ceramic tray. You may wish to leave a cup of water standing inside the oven when it is not in use to prevent damage if the oven is accidentally turned on.

Part	Recommendations
Oven cavity	Keep inside (cavity) of the oven clean. Food particles and spilled liquids can stick to the oven walls, causing the oven to work less efficiently. Wipe up spills immediately. Use a damp, clean cloth and mild soap. DO NOT use harsh detergents or abrasive cleaners. To help loosen baked-on food particles or liquids, heat 2 cups of water (add the juice of 1 lemon if you desire to keep the oven fresh smelling) in a 4 cup measuring glass at High power for 5 minutes or until boiling. Let stand in oven cavity for 1 or 2 minutes. For baked-on grease spatters, wash with hot, soapy water, rinse and dry.
Wire rack	Wash with soapy water. Rinse thoroughly and dry, or gently rub with cleansing powder or soap-filled pads as directed. The wire rack can also be washed in the dishwasher.
Metal turntable tray	Remove metal turntable tray from the oven when cleaning the oven cavity and tray. Wash the metal turntable tray in warm sudsy water or in the dishwasher.
Ceramic tray	Clean with warm, soapy water or in the dishwasher.
Door seal	Wipe with damp cloth.

Part	Recommendations
Door glass	Wash with soap and water or glass cleaner. Apply Fantastik® or Formula 409® to a clean sponge or paper towel and wipe clean. Avoid using powder cleaning agents, steel wool pads and oven cleaners. If steam accumulates inside or outside the oven door, wipe with a soft cloth. Steam can accumulate when operating the oven in high humidity and in no way indicates microwave leakage.
Painted surfaces	Clean with hot soapy water or apply Fantastik® or Formula 409® to a clean sponge or paper towel and wipe clean. Avoid using powder cleaning agents, steel wool pads and oven cleaners.
Stainless steel surfaces/exterior surfaces	Always wipe or rub in the direction of the grain. Clean with a soapy sponge, then rinse and dry, or wipe with Fantastik® or Formula 409® spray on a paper towel. Protect and polish with Stainless Steel Magic® and a soft cloth. Remove water spots with a cloth dampened with white vinegar.
Plastic & Controls	When cool, clean with soapy water, rinse and dry.
Printed areas (words & numbers)	Do not use abrasive cleaners or petroleum based solvents.