



SCAN TO VIEW
IN YOUR KITCHEN



Product: 30-inch Built-in Microwave Speed Oven
Model Number: TM030

TECHNICAL DETAILS

Installation Type	Built-In
Color/Finish	Stainless Steel
Capacity	1.6 cu. ft.
Microwave Power	1000W
Circuit Breaker	20A
Volts	120 VAC
Frequency	60Hz
Plug Type	3-Prong Grounding Plug
Power Cord Length	59 1/16"
Accessories Included	Reversible Rack Turntable Ceramic Plate

CONTROL PANEL DETAILS/ FEATURES

Sensor Cook	Yes
Defrost	Yes
Child Safety Lock	Panel Lock - Activate/Deactivate Childproof Lock
Control Lock	Yes
Power Levels	10
Cooking Modes	Auto Defrost, Air Fry, Sensor Cook, Sensor Reheat, Popcorn, Beverage, Pizza And Auto Menu
Memory/Kitchen Timer	Yes
Start/Add-A-Minute	Yes - Add 30 Seconds
Timer/Clock	Yes

FEATURES & BENEFITS

- Powerful Performance:** Boasting a 1000-watt output with 10 power levels, convection fan, broiler, and baking elements for versatile culinary adventures.
- Spacious Storage:** 1.6 cu ft Stainless Steel Cavity for easy cleaning and spacious design.
- Ceramic Speed Cooking Plate:** 14.1 inch ceramic plate provides even heating for speed cooking and pizzas.
- Air Fry:** Experience crispy perfection while reducing oil usage for healthier indulgence.
- Sleek Design:** Stainless steel built-in cabinet design features a full touch LCD display that's easy to operate and clean.
- Control Panel Child Lock:** Securely keep your kitchen safe with the child lock feature.



PRODUCT DIMENSIONS & WEIGHT

Product Dimensions (WxDxH)	29 7/8" x 24 7/16" x 19 7/16"
Cavity Dimensions (WxDxH)	16 9/16" x 16 9/16" x 9 13/16"
Cutout Dimensions (WxDxH)	22 1/16" x 21 5/8" x 17 3/4"
Turnable Diameter	14 1/10"
Net Weight	89.29 lbs
Gross Weight	99.87 lbs



WARRANTY: 2 YEARS PARTS AND LABOR



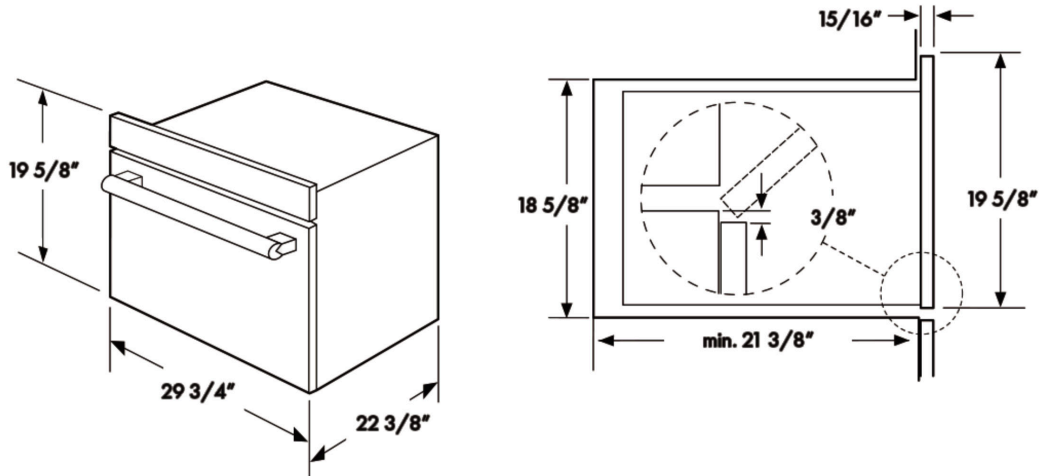

Ventilation openings behind, min $38 \frac{3}{4} \text{ in}^2$

