



HARVEY

WINDOWS + DOORS

Standard Call Sizes

REFERENCE Standard New Construction (w)



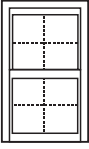
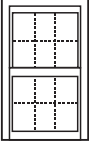
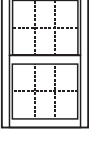
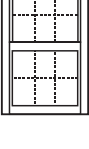
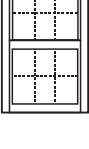
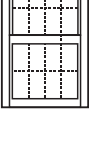

Vinyl Double Hung

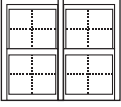
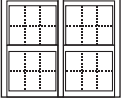
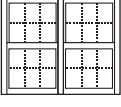
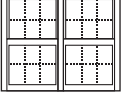
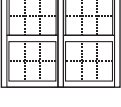
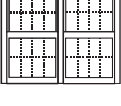
Default Grid Pattern	Rough Opening	Code
	1' 10" (w)	
	3' 1-1/2" (h)	W18210
	3' 5-1/2" (h)	W1832
	4' 1-1/2" (h)	W18310
	4' 5-1/2" (h)	W1842
	4' 9-1/2" (h)	W1846
	5' 1-1/2" (h)	W18410
	5' 5-1/2" (h)	W1852
5' 9-1/2" (h)	W1856	
	2' 2" (w)	
	3' 1-1/2" (h)	W20210
	3' 5-1/2" (h)	W2032
	4' 1-1/2" (h)	W20310
	4' 5-1/2" (h)	W2042
	4' 9-1/2" (h)	W2046
	5' 1-1/2" (h)	W20410
	5' 5-1/2" (h)	W2052
5' 9-1/2" (h)	W2056	
	2' 6" (w)	
	3' 1-1/2" (h)	W24210
	3' 5-1/2" (h)	W2432
	4' 1-1/2" (h)	W24310
	4' 5-1/2" (h)	W2442
	4' 9-1/2" (h)	W2446
	5' 1-1/2" (h)	W24410
	5' 5-1/2" (h)	W2452
5' 9-1/2" (h)	W2456	
	2' 10" (w)	
	3' 1-1/2" (h)	W28210
	3' 5-1/2" (h)	W2832
	4' 1-1/2" (h)	W28310
	4' 5-1/2" (h)	W2842
	4' 9-1/2" (h)	W2846
	5' 1-1/2" (h)	W28410
	5' 5-1/2" (h)	W2852
5' 9-1/2" (h)	W2856	
	2' 11-1/2" (w)	
	3' 1-1/2" (h)	W29210
	3' 5-1/2" (h)	W2932
	4' 1-1/2" (h)	W29310
	4' 5-1/2" (h)	W2942
	4' 9-1/2" (h)	W2946
	5' 1-1/2" (h)	W29410
	5' 5-1/2" (h)	W2952
5' 9-1/2" (h)	W2956	
	3' 2" (w)	
	3' 1-1/2" (h)	W30210
	3' 5-1/2" (h)	W3032
	4' 1-1/2" (h)	W30310
	4' 5-1/2" (h)	W3042
	4' 9-1/2" (h)	W3046
	5' 1-1/2" (h)	W30410
	5' 5-1/2" (h)	W3052
5' 9-1/2" (h)	W3056	

2-Wide Double Hung w/Common Jamb

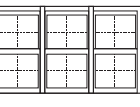
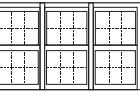
Default Grid Pattern	Rough Opening	Code
	3' 5-3/4" (w)	
	3' 1-1/2" (h)	W18210-2
	3' 5-1/2" (h)	W1832-2
	4' 1-1/2" (h)	W18310-2
	4' 5-1/2" (h)	W1842-2
	4' 9-1/2" (h)	W1846-2
	5' 1-1/2" (h)	W18410-2
	5' 5-1/2" (h)	W1852-2
	5' 9-1/2" (h)	W1856-2
		4' 2-1/4" (w)
3' 1-1/2" (h)		W20210-2
3' 5-1/2" (h)		W2032-2
4' 1-1/2" (h)		W20310-2
4' 5-1/2" (h)		W2042-2
4' 9-1/2" (h)		W2046-2
5' 1-1/2" (h)		W20410-2
5' 5-1/2" (h)		W2052-2
5' 9-1/2" (h)		W2056-2
		4' 10-1/4" (w)
	3' 1-1/2" (h)	W24210-2
	3' 5-1/2" (h)	W2432-2
	4' 1-1/2" (h)	W24310-2
	4' 5-1/2" (h)	W2442-2
	4' 9-1/2" (h)	W2446-2
	5' 1-1/2" (h)	W24410-2
	5' 5-1/2" (h)	W2452-2
	5' 9-1/2" (h)	W2456-2
		5' 6-1/4" (w)
3' 1-1/2" (h)		W28210-2
3' 5-1/2" (h)		W2832-2
4' 1-1/2" (h)		W28310-2
4' 5-1/2" (h)		W2842-2
4' 9-1/2" (h)		W2846-2
5' 1-1/2" (h)		W28410-2
5' 5-1/2" (h)		W2852-2
5' 9-1/2" (h)		W2856-2
		5' 9-1/4" (w)
	3' 1-1/2" (h)	W29210-2
	3' 5-1/2" (h)	W2932-2
	4' 1-1/2" (h)	W29310-2
	4' 5-1/2" (h)	W2942-2
	4' 9-1/2" (h)	W2946-2
	5' 1-1/2" (h)	W29410-2
	5' 5-1/2" (h)	W2952-2
	5' 9-1/2" (h)	W2956-2
		6' 2-1/4" (w)
3' 1-1/2" (h)		W30210-2
3' 5-1/2" (h)		W3032-2
4' 1-1/2" (h)		W30310-2
4' 5-1/2" (h)		W3042-2
4' 9-1/2" (h)		W3046-2
5' 1-1/2" (h)		W30410-2
5' 5-1/2" (h)		W3052-2
5' 9-1/2" (h)		W3056-2

3-Wide Equal Double Hung w/Common Jamb

Default Grid Pattern	Rough Opening	Code
	5' 2-3/4" (w)	
	3' 1-1/2" (h)	W18210-3
	3' 5-1/2" (h)	W1832-3
	4' 1-1/2" (h)	W18310-3
	4' 5-1/2" (h)	W1842-3
	4' 9-1/2" (h)	W1846-3
	5' 1-1/2" (h)	W18410-3
	5' 5-1/2" (h)	W1852-3
5' 9-1/2" (h)	W1856-3	
	6' 2-3/4" (w)	
	3' 1-1/2" (h)	W20210-3
	3' 5-1/2" (h)	W2032-3
	4' 1-1/2" (h)	W20310-3
	4' 5-1/2" (h)	W2042-3
	4' 9-1/2" (h)	W2046-3
	5' 1-1/2" (h)	W20410-3
	5' 5-1/2" (h)	W2052-3
5' 9-1/2" (h)	W2056-3	
	7' 2-3/4" (w)	
	3' 1-1/2" (h)	W24210-3
	3' 5-1/2" (h)	W2432-3
	4' 1-1/2" (h)	W24310-3
	4' 5-1/2" (h)	W2442-3
	4' 9-1/2" (h)	W2446-3
	5' 1-1/2" (h)	W24410-3
	5' 5-1/2" (h)	W2452-3
5' 9-1/2" (h)	W2456-3	
	8' 2-3/4" (w)	
	3' 1-1/2" (h)	W28210-3
	3' 5-1/2" (h)	W2832-3
	4' 1-1/2" (h)	W28310-3
	4' 5-1/2" (h)	W2842-3
	4' 9-1/2" (h)	W2846-3
	5' 1-1/2" (h)	W28410-3
	5' 5-1/2" (h)	W2852-3
5' 9-1/2" (h)	W2856-3	
	8' 7-1/4" (w)	
	3' 1-1/2" (h)	W29210-3
	3' 5-1/2" (h)	W2932-3
	4' 1-1/2" (h)	W29310-3
	4' 5-1/2" (h)	W2942-3
	4' 9-1/2" (h)	W2946-3
	5' 1-1/2" (h)	W29410-3
	5' 5-1/2" (h)	W2952-3
5' 9-1/2" (h)	W2956-3	
	9' 2-3/4" (w)	
	3' 1-1/2" (h)	W30210-3
	3' 5-1/2" (h)	W3032-3
	4' 1-1/2" (h)	W30310-3
	4' 5-1/2" (h)	W3042-3
	4' 9-1/2" (h)	W3046-3
	5' 1-1/2" (h)	W30410-3
	5' 5-1/2" (h)	W3052-3
5' 9-1/2" (h)	W3056-3	

RO to UNIT DIMENSIONS	
Minus 1/2" from width	Minus 1/2" from height

RO to UNIT DIMENSIONS	
Minus 1/2" from width	Minus 1/2" from height

RO to UNIT DIMENSIONS	
Minus 3/4" from width	Minus 1/2" from height

This guide contains two call size types for double-hung windows, since different markets use different call sizes. (W) indicates the size matches wood manufactured sizes and (V) indicates the size matches vinyl manufactured sizes. You can mix sizes in an order.

REFERENCE Standard New Construction (w)

3-Wide w/ Picture Window & Common Jamb

Default Grid Pattern	Rough Opening	Code
	7' 6-3/4" (w)	
	4' 1" (h)	W18-40310-18
	4' 5" (h)	W18-4042-18
	4' 9" (h)	W18-4046-18
	5' 5" (h)	W18-4052-18
	8' 2-3/4" (w)	
	4' 1" (h)	W20-40310-20
	4' 5" (h)	W20-4042-20
	4' 9" (h)	W20-4046-20
	5' 5" (h)	W20-4052-20
	8' 6-3/4" (w)	
	4' 1" (h)	W18-50310-18
	4' 5" (h)	W18-5042-18
	4' 9" (h)	W18-5046-18
	5' 5" (h)	W18-5052-18
	9' 2-3/4" (w)	
	4' 1" (h)	W20-50310-20
	4' 5" (h)	W20-5042-20
	4' 9" (h)	W20-5046-20
	5' 5" (h)	W20-5052-20

RO to UNIT DIMENSIONS	
Minus 3/4" from width	Minus 1/2" from height

Vinyl Casement

Default Grid Pattern	Rough Opening	Code
	1' 9-1/2" (w)	
	3' 0" (h)	193
	3' 6" (h)	1936
	4' 0" (h)	194
	4' 6" (h)	1946
	5' 0" (h)	195
	2' 0-1/2" (w)	
	3' 0" (h)	203
	3' 6" (h)	2036
	4' 0" (h)	204
	4' 6" (h)	2046
	5' 0" (h)	205
	2' 5" (w)	
	3' 0" (h)	243
	3' 6" (h)	2436
	4' 0" (h)	244
	4' 6" (h)	2446
	5' 0" (h)	245
	2' 8" (w)	
	3' 0" (h)	283
	3' 6" (h)	2836
	4' 0" (h)	284
	4' 6" (h)	2846
	5' 0" (h)	285
	2' 9-3/4" (w)	
	3' 0" (h)	303-2
	3' 6" (h)	3036-2
	4' 0" (h)	304-2
	4' 6" (h)	3046-2
	5' 0" (h)	305-2
	3' 5-3/4" (w)	
	3' 0" (h)	363-2
	3' 6" (h)	3636-2
	4' 0" (h)	364-2
	4' 6" (h)	3646-2
	5' 0" (h)	365-2
	3' 11-3/4" (w)	
	3' 0" (h)	403-2
	3' 6" (h)	4036-2
	4' 0" (h)	404-2
	4' 6" (h)	4046-2
	5' 0" (h)	405-2
	4' 8-3/4" (w)	
	3' 0" (h)	483-2
	3' 6" (h)	4836-2
	4' 0" (h)	484-2
	4' 6" (h)	4846-2
	5' 0" (h)	485-2
	5' 11-1/4" (w)	
	3' 0" (h)	603-3
	3' 6" (h)	6036-3
	4' 0" (h)	604-3
	4' 6" (h)	6046-3
	5' 0" (h)	605-3
	6' 0" (h)	606-3

RO to UNIT DIMENSIONS
Minus 1/2" from width*
Minus 3/4" from height

*Minus 3/4" from width for 3 wide

Sizes shaded in grey have a 5.70 sq. ft. clear opening or better. Check with your local building department for egress requirements.

REFERENCE Standard New Construction (v)

Vinyl Double Hung

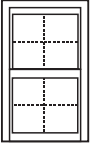
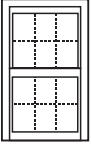
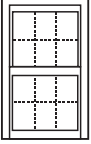
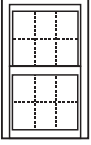
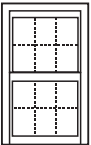
Default Grid Pattern	Rough Opening	Code
	2' 0" (w)	
	3' 0" (h)	2030V
	3' 6" (h)	2036V
	4' 0" (h)	2040V
	4' 6" (h)	2046V
	5' 0" (h)	2050V
	5' 2" (h)	2052V
	5' 6" (h)	2056V
	6' 0" (h)	2060V
	2' 4" (w)	
	3' 0" (h)	2430V
	3' 6" (h)	2436V
	4' 0" (h)	2440V
	4' 6" (h)	2446V
	5' 0" (h)	2450V
	5' 2" (h)	2452V
	5' 6" (h)	2456V
	6' 0" (h)	2460V
	2' 8" (w)	
	3' 0" (h)	2830V
	3' 6" (h)	2836V
	4' 0" (h)	2840V
	4' 6" (h)	2846V
	5' 0" (h)	2850V
	5' 2" (h)	2852V
	5' 6" (h)	2856V
	6' 0" (h)	2860V
	3' 0" (w)	
	3' 0" (h)	3030V
	3' 6" (h)	3036V
	4' 0" (h)	3040V
	4' 6" (h)	3046V
	5' 0" (h)	3050V
	5' 2" (h)	3052V
	5' 6" (h)	3056V
	6' 0" (h)	3060V
	3' 2" (w)	
	4' 0" (h)	3240V
	4' 6" (h)	3246V
	5' 0" (h)	3250V
	5' 2" (h)	3252V



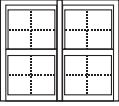
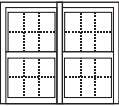
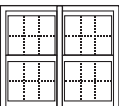
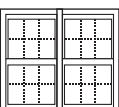
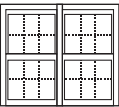

RO to UNIT DIMENSIONS	
Minus 1/2" from width	Minus 1/2" from height

2-Wide Double Hung w/Common Jamb

Default Grid Pattern	Rough Opening	Code	
	3' 10-1/4" (w)		
	3' 0" (h)	2030-2V	
	3' 6" (h)	2036-2V	
	4' 0" (h)	2040-2V	
	4' 6" (h)	2046-2V	
	5' 0" (h)	2050-2V	
	5' 2" (h)	2052-2V	
	5' 6" (h)	2056-2V	
	6' 0" (h)	2060-2V	
		4' 6-1/4" (w)	
		3' 0" (h)	2430-2V
3' 6" (h)		2436-2V	
4' 0" (h)		2440-2V	
4' 6" (h)		2446-2V	
5' 0" (h)		2450-2V	
5' 2" (h)		2452-2V	
5' 6" (h)		2456-2V	
6' 0" (h)		2460-2V	
		5' 2-1/4" (w)	
		3' 0" (h)	2830-2V
	3' 6" (h)	2836-2V	
	4' 0" (h)	2840-2V	
	4' 6" (h)	2846-2V	
	5' 0" (h)	2850-2V	
	5' 2" (h)	2852-2V	
	5' 6" (h)	2856-2V	
	6' 0" (h)	2860-2V	
		5' 10-1/4" (w)	
		3' 0" (h)	3030-2V
3' 6" (h)		3036-2V	
4' 0" (h)		3040-2V	
4' 6" (h)		3046-2V	
5' 0" (h)		3050-2V	
5' 2" (h)		3052-2V	
5' 6" (h)		3056-2V	
6' 0" (h)		3060-2V	
		6' 2-1/4" (w)	
		4' 0" (h)	3240-2V
	4' 6" (h)	3246-2V	
	5' 0" (h)	3250-2V	
	5' 2" (h)	3252-2V	

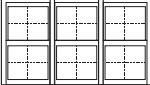
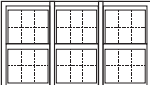
RO to UNIT DIMENSIONS	
Minus 1/2" from width	Minus 1/2" from height

3-Wide Equal Double Hung w/Common Jamb

Default Grid Pattern	Rough Opening	Code	
	5' 8-1/2" (w)		
	3' 0" (h)	2030-3V	
	3' 6" (h)	2036-3V	
	4' 0" (h)	2040-3V	
	4' 6" (h)	2046-3V	
	5' 0" (h)	2050-3V	
	5' 2" (h)	2052-2V	
	5' 6" (h)	2056-2V	
	6' 0" (h)	2060-2V	
		6' 8-1/2" (w)	
		3' 0" (h)	2430-3V
3' 6" (h)		2436-3V	
4' 0" (h)		2440-3V	
4' 6" (h)		2446-3V	
5' 0" (h)		2450-3V	
5' 2" (h)		2452-3V	
5' 6" (h)		2456-3V	
6' 0" (h)		2460-3V	
		7' 8-1/2" (w)	
		3' 0" (h)	2830-3V
	3' 6" (h)	2836-3V	
	4' 0" (h)	2840-3V	
	4' 6" (h)	2846-3V	
	5' 0" (h)	2850-3V	
	5' 2" (h)	2852-3V	
	5' 6" (h)	2856-3V	
	6' 0" (h)	2860-3V	
		8' 8-1/4" (w)	
		3' 0" (h)	3030-3V
3' 6" (h)		3036-3V	
4' 0" (h)		3040-3V	
4' 6" (h)		3046-3V	
5' 0" (h)		3050-3V	
5' 2" (h)		3052-3V	
5' 6" (h)		3056-3V	
6' 0" (h)		3060-3V	
		9' 2-1/4" (w)	
		4' 0" (h)	3240-3V
	4' 6" (h)	3246-3V	
	5' 0" (h)	3250-3V	
	5' 2" (h)	3252-3V	

RO to UNIT DIMENSIONS	
Minus 1/2" from width	Minus 1/2" from height

This guide contains two call size types for double-hung windows, since different markets use different call sizes. (W) indicates the size matches wood manufactured sizes and (V) indicates the size matches vinyl manufactured sizes. You can mix sizes in an order.

REFERENCE Standard New Construction (v)

3-Wide w/ Picture Window & Common Jamb

Default Grid Pattern	Rough Opening	Code
	7' 8-1/2" (w)	
	3' 0" (h)	20-4030-20V
	4' 0" (h)	20-4040-20V
	5' 0" (h)	20-4050-20V
	5' 2" (h)	20-4052-20V
	8' 4-1/2" (w)	
	3' 0" (h)	24-4030-24V
	4' 0" (h)	24-4040-24V
	5' 0" (h)	24-4050-24V
	5' 2" (h)	24-4052-24V
	8' 8-1/2" (w)	
	3' 0" (h)	20-5030-20V
	4' 0" (h)	20-5040-20V
	5' 0" (h)	20-5050-20V
	5' 2" (h)	20-5052-20V
	9' 4-1/2" (w)	
	3' 0" (h)	24-5030-24V
	4' 0" (h)	24-5040-24V
	5' 0" (h)	24-5050-24V
	5' 2" (h)	24-5052-24V

RO to UNIT DIMENSIONS	
Minus 1/2" from width	Minus 1/2" from height

Sizes shaded in grey have a 5.70 sq. ft. clear opening or better. Check with your local building department for egress requirements.







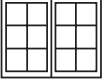

Vinyl Casement

Default Grid Pattern	Rough Opening	Code
	1' 9-1/2" (w)	
	3' 0" (h)	193
	3' 6" (h)	1936
	4' 0" (h)	194
	4' 6" (h)	1946
	5' 0" (h)	195
	6' 0" (h)	196
	2' 0-1/2" (w)	
	3' 0" (h)	203
	3' 6" (h)	2036
	4' 0" (h)	204
	4' 6" (h)	2046
	5' 0" (h)	205
	6' 0" (h)	206
	2' 5" (w)	
	3' 0" (h)	243
	3' 6" (h)	2436
	4' 0" (h)	244
	4' 6" (h)	2446
	5' 0" (h)	245
	6' 0" (h)	246
	2' 8" (w)	
	3' 0" (h)	283
	3' 6" (h)	2836
	4' 0" (h)	284
	4' 6" (h)	2846
	5' 0" (h)	285
	6' 0" (h)	286
	2' 9-3/4" (w)	
	3' 0" (h)	303-2
	3' 6" (h)	3036-2
	4' 0" (h)	304-2
	4' 6" (h)	3046-2
	5' 0" (h)	305-2
	6' 0" (h)	306-2
	3' 5-3/4" (w)	
	3' 0" (h)	363-2
	3' 6" (h)	3636-2
	4' 0" (h)	364-2
	4' 6" (h)	3646-2
	5' 0" (h)	365-2
	6' 0" (h)	366-2
	3' 11-3/4" (w)	
	3' 0" (h)	403-2
	3' 6" (h)	4036-2
	4' 0" (h)	404-2
	4' 6" (h)	4046-2
	5' 0" (h)	405-2
	6' 0" (h)	406-2
	4' 8-3/4" (w)	
	3' 0" (h)	483-2
	3' 6" (h)	4836-2
	4' 0" (h)	484-2
	4' 6" (h)	4846-2
	5' 0" (h)	485-2
	6' 0" (h)	486-2
	5' 11-1/4" (w)	
	3' 0" (h)	603-3
	3' 6" (h)	6036-3
	4' 0" (h)	604-3
	4' 6" (h)	6046-3
	5' 0" (h)	605-3
	6' 0" (h)	606-3

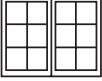
RO to UNIT DIMENSIONS
Minus 1/2" from width*
Minus 3/4" from height

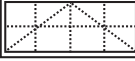
*Minus 3/4" from width for 3 wide

REFERENCE Vinyl Standard New Construction Call Sizes

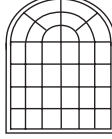
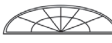
Rolling Vinyl Window			Vinyl Awning			Vinyl Shapes		
	Rough Opening	Code		Rough Opening	Code		Rough Opening	Code
	3' 6" (w) 3' 6" (h)	RW3636		2' 0-1/2" (w) 2' 0-1/2" (h)	AWN21		2' 10" (w) 1' 5-1/4" (h)	HRD28J
	4' 0" (w) 3' 6" (h)	RW4036		3' 0-1/2" (w) 2' 0-1/2" (h)	AWN31		2' 11-1/2" (w) 1' 5-3/4" (h)	HRD29J
				4' 0-1/2" (w) 2' 0-1/2" (h)	AWN41		3' 2" (w) 1' 7-1/4" (h)	HRD30J
							5' 5-3/4" (w) 2' 8-7/8" (h)	HRD28-2J
							5' 9-1/4" (w) 2' 10-7/8" (h)	HRD29-2
							3' 11-3/4" (w) 2' 0-1/8" (h)	HRC40
							5' 4-3/8" (w) 6' 3-1/2" (h)	EHR6475J
							6' 0-1/2" (w) 1' 5-3/4" (h)	ET6J

CLEAR OPENING SPECS Custom Wood and Vinyl Windows

REPLACEMENT WINDOW MEASURING INSTRUCTIONS

Measuring Width:

Measure between the jambs at three locations: bottom, center, and top (Diagram A).
Use the smallest dimension if the three vary.

Measuring Height:

Measure from highest point of the sloped sill to the highest point of header pocket (Diagram B).

Measuring Frame Depth:

Harvey vinyl double hung AND Majesty wood windows are designed to fit a frame depth of 3-1/4".
Compensation for other than 3-1/4" will have to be made on the job.

Adjustability for Vinyl Windows: The "U" channel vinyl head expander allows windows to be expanded up to 5/8" in height.

The above measurements are rough opening sizes. You must deduct 1/4" off the width and 1/2" off the height, and round down to the nearest 1/4", to get your buck size (buck size is the size the window will be).
Width and height buck dimensions can only be ordered in 1/4", 1/2", 3/4", and full 1" sizes.

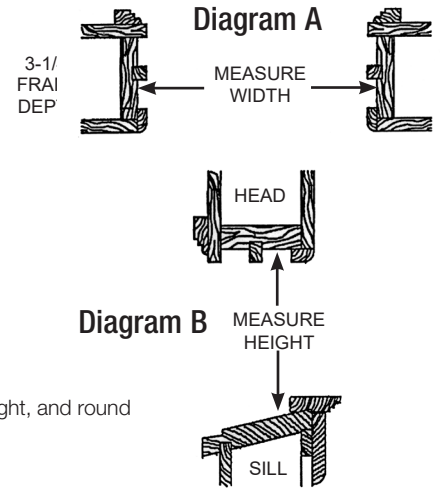

VINYL WINDOWS

In most states you must meet a clear opening requirement and a square foot requirement.
Consult your local building department for code requirements in your area.

Unit		Clear Opening Unit TTT	
		Width(W)	Height(H)
Tribute Double Hung	welded frame & sash:	W - 5"	H/2 - 4-3/8"
Classic Double Hung	welded frame & sash:	W - 5"	H/2 - 5-1/8"
Slimline SH & DH	welded frame & sash:	W - 5-1/4"	H/2 - 4-7/16"
Casement Window	standard hinge:	W - 11-1/2"	H - 5-3/4"
Casement Window	egress hinge:	W - 7-1/4"	H - 5-3/4"
Rolling Window	2-lite:	W/2 - 5-3/16"	H - 4-5/8"
Rolling Window	3-lite (qtr-half-qtr):	W/4 - 2-7/16"	H - 4-5/8"
Rolling Window	3-lite (equal lite):	W/3 - 5"	H - 4-5/8"
Clear opening w/sill riser in place		Width(W)	Height(H)
Tribute Double Hung	welded frame & sash:	W - 5"	H/2 - 4-15/16"
Classic Double Hung	welded frame & sash:	W - 5"	H/2 - 5-11/16"
Slimline SH & DH	welded frame & sash:	W - 5-1/4"	H/2 - 5"

Clear opening square footage formula: Clear opening width x clear opening height/144

Typical egress requirements include 20" width and 24" height clear opening minimum dimensions and 5.7 square feet of total minimum clear opening.
Example (using Classic double hung with welded frame & sash):

If Unit Buck Size = 36" x 64"

Clear opening Width:	$36" - 5" = 31" (31")$	greater than 20"
Clear opening Height:	$64"/2 = 32" - 5-1/4" = 26-3/4"$	greater than 24"
Square footage of opening:	$31" \times 26-3/4" = 829"/144" = 5.75 \text{ sq.ft.}$	greater than 5.70 sq ft.

MAJESTY WINDOWS

Unit	Clear Opening Unit TTT	
	Width(W)	Height(H)
Majesty Double Hung	W - 3-7/8"	H/2 - 6-1/4"
Majesty Casement	W - 8-1/2"	H - 4-3/4"

CLEAR OPENING SPECS Standard NC Windows (w)

Slimline DH/SH			Classic DH/SH			Tribute DH		
Code	Clear Opening		SQ. FT	Clear Opening		SQ. FT	Clear Opening	
	SQ. FT	(W X H) INCHES		(W X H) INCHES	(W X H) INCHES			
W18210	1.60	16-1/4 x 14-1/16	1.50	16-1/2 x 13-1/4	1.60	16-1/2 x 14-1/8		
W1832	1.80	16-1/4 x 16-1/16	1.70	16-1/2 x 15-1/4	1.80	16-1/2 x 16-1/8		
W18310	2.30	16-1/4 x 20-1/16	2.20	16-1/2 x 19-1/4	2.30	16-1/2 x 20-1/8		
W1842	2.50	16-1/4 x 22-1/16	2.40	16-1/2 x 21-1/4	2.50	16-1/2 x 22-1/8		
W1846	2.70	16-1/4 x 24-1/16	2.70	16-1/2 x 23-1/4	2.80	16-1/2 x 24-1/8		
W18410	2.90	16-1/4 x 26-1/16	2.90	16-1/2 x 25-1/4	3.00	16-1/2 x 26-1/8		
W1852	3.20	16-1/4 x 28-1/16	3.10	16-1/2 x 27-1/4	3.20	16-1/2 x 28-1/8		
W1856	3.40	16-1/4 x 30-1/16	3.40	16-1/2 x 29-1/4	3.50	16-1/2 x 30-1/8		
W1862	3.80	16-1/4 x 34-1/16	3.80	16-1/2 x 33-1/4	3.90	16-1/2 x 34-1/8		
W20210	2.00	20-1/4 x 14-1/16	1.90	20-1/2 x 13-1/4	2.00	20-1/2 x 14-1/8		
W2032	2.30	20-1/4 x 16-1/16	2.20	20-1/2 x 15-1/4	2.30	20-1/2 x 16-1/8		
W20310	2.80	20-1/4 x 20-1/16	2.70	20-1/2 x 19-1/4	2.90	20-1/2 x 20-1/8		
W2042	3.10	20-1/4 x 22-1/16	3.00	20-1/2 x 21-1/4	3.10	20-1/2 x 22-1/8		
W2046	3.40	20-1/4 x 24-1/16	3.30	20-1/2 x 23-1/4	3.40	20-1/2 x 24-1/8		
W20410	3.70	20-1/4 x 26-1/16	3.60	20-1/2 x 25-1/4	3.70	20-1/2 x 26-1/8		
W2052	3.90	20-1/4 x 28-1/16	3.90	20-1/2 x 27-1/4	4.00	20-1/2 x 28-1/8		
W2056	4.20	20-1/4 x 30-1/16	4.20	20-1/2 x 29-1/4	4.30	20-1/2 x 30-1/8		
W2062	4.80	20-1/4 x 34-1/16	4.70	20-1/2 x 33-1/4	4.90	20-1/2 x 34-1/8		
W24210	2.40	24-1/4 x 14-1/16	2.30	24-1/2 x 13-1/4	2.40	24-1/2 x 14-1/8		
W2432	2.70	24-1/4 x 16-1/16	2.60	24-1/2 x 15-1/4	2.70	24-1/2 x 16-1/8		
W24310	3.40	24-1/4 x 20-1/16	3.30	24-1/2 x 19-1/4	3.40	24-1/2 x 20-1/8		
W2442	3.70	24-1/4 x 22-1/16	3.60	24-1/2 x 21-1/4	3.80	24-1/2 x 22-1/8		
W2446	4.10	24-1/4 x 24-1/16	4.00	24-1/2 x 23-1/4	4.10	24-1/2 x 24-1/8		
W24410	4.40	24-1/4 x 26-1/16	4.30	24-1/2 x 25-1/4	4.40	24-1/2 x 26-1/8		
W2452	4.70	24-1/4 x 28-1/16	4.60	24-1/2 x 27-1/4	4.80	24-1/2 x 28-1/8		
W2456	5.10	24-1/4 x 30-1/16	5.00	24-1/2 x 29-1/4	5.10	24-1/2 x 30-1/8		
W2462	5.70	24-1/4 x 34-1/16	5.70	24-1/2 x 33-1/4	5.80	24-1/2 x 34-1/8		
W28210	2.80	28-1/4 x 14-1/16	2.60	28-1/2 x 13-1/4	2.80	28-1/2 x 14-1/8		
W2832	3.20	28-1/4 x 16-1/16	3.00	28-1/2 x 15-1/4	3.20	28-1/2 x 16-1/8		
W28310	3.90	28-1/4 x 20-1/16	3.80	28-1/2 x 19-1/4	4.00	28-1/2 x 20-1/8		
W2842	4.30	28-1/4 x 22-1/16	4.20	28-1/2 x 21-1/4	4.40	28-1/2 x 22-1/8		
W2846	4.70	28-1/4 x 24-1/16	4.60	28-1/2 x 23-1/4	4.80	28-1/2 x 24-1/8		
W28410	5.10	28-1/4 x 26-1/16	5.00	28-1/2 x 25-1/4	5.20	28-1/2 x 26-1/8		
W2852	5.50	28-1/4 x 28-1/16	5.40	28-1/2 x 27-1/4	5.60	28-1/2 x 28-1/8		
W2856	5.90	28-1/4 x 30-1/16	5.80	28-1/2 x 29-1/4	6.00	28-1/2 x 30-1/8		
W29210	2.90	29-3/4 x 14-1/16	2.80	30 x 13-1/4	2.90	30 x 14-1/8		
W2932	3.30	29-3/4 x 16-1/16	3.20	30 x 15-1/4	3.40	30 x 16-1/8		
W29310	4.10	29-3/4 x 20-1/16	4.00	30 x 19-1/4	4.20	30 x 20-1/8		
W2942	4.60	29-3/4 x 22-1/16	4.40	30 x 21-1/4	4.60	30 x 22-1/8		
W2946	5.00	29-3/4 x 24-1/16	4.80	30 x 23-1/4	5.00	30 x 24-1/8		
W29410	5.40	29-3/4 x 26-1/16	5.30	30 x 25-1/4	5.40	30 x 26-1/8		
W2956	6.20	29-3/4 x 30-1/16	6.10	30 x 29-1/4	6.30	30 x 30-1/8		
W2962	7.00	29-3/4 x 34-1/16	6.90	30 x 33-1/4	7.10	30 x 34-1/8		
W30210	3.10	32-1/4 x 14-1/16	3.00	32-1/2 x 13-1/4	3.20	32-1/2 x 14-1/8		
W3032	3.60	32-1/4 x 16-1/16	3.40	32-1/2 x 15-1/4	3.60	32-1/2 x 16-1/8		
W30310	4.50	32-1/4 x 20-1/16	4.30	32-1/2 x 19-1/4	4.50	32-1/2 x 20-1/8		
W3042	4.90	32-1/4 x 22-1/16	4.80	32-1/2 x 21-1/4	5.00	32-1/2 x 22-1/8		
W3046	5.40	32-1/4 x 24-1/16	5.20	32-1/2 x 23-1/4	5.40	32-1/2 x 24-1/8		
W30410	5.80	32-1/4 x 26-1/16	5.70	32-1/2 x 25-1/4	5.90	32-1/2 x 26-1/8		
W3052	6.30	32-1/4 x 28-1/16	6.20	32-1/2 x 27-1/4	6.30	32-1/2 x 28-1/8		
W3056	6.70	32-1/4 x 30-1/16	6.60	32-1/2 x 29-1/4	6.80	32-1/2 x 30-1/8		

NOTES: These specs do not apply to oriel windows. Use of sill rise adaptor will result in a 9/16" reduction in clear opening height. This guide contains two call size types for double-hung windows, since different markets use different call sizes. (W) indicates the size matches wood manufactured sizes and (V) indicates the size matches vinyl manufactured sizes. You can mix sizes in an order.

CLEAR OPENING SPECS Standard NC Windows (v)

Slimline DH/SH			Classic DH/SH		Tribute DH	
Code	Clear Opening		Clear Opening		Clear Opening	
	SQ. FT	(W X H) INCHES	SQ. FT	(W X H) INCHES	SQ. FT	(W X H) INCHES
2030V	1.69	18-1/4 x 13-5/16	1.62	18-1/2 x 12-5/8	1.72	18-1/2 x 13-3/8
2036V	2.07	18-1/4 x 16-5/16	2.01	18-1/2 x 15-5/8	2.10	18-1/2 x 16-3/8
2040V	2.45	18-1/4 x 19-5/16	2.39	18-1/2 x 18-5/8	2.49	18-1/2 x 19-3/8
2046V	2.83	18-1/4 x 22-5/16	2.78	18-1/2 x 21-5/8	2.83	18-1/2 x 22-3/8
2050V	3.21	18-1/4 x 25-5/16	3.16	18-1/2 x 24-5/8	3.26	18-1/2 x 25-3/8
2052V	3.33	18-1/4 x 26-5/16	3.29	18-1/2 x 25-5/8	3.39	18-1/2 x 26-3/8
2056V	3.59	18-1/4 x 28-5/16	3.55	18-1/2 x 27-5/8	3.65	18-1/2 x 28-3/8
2060V	3.97	18-1/4 x 31-5/16	3.93	18-1/2 x 30-5/8	4.03	18-1/2 x 31-3/8
2430V	2.06	22-1/4 x 13-5/16	1.97	22-1/2 x 12-5/8	2.09	22-1/2 x 13-3/8
2436V	2.52	22-1/4 x 16-5/16	2.44	22-1/2 x 15-5/8	2.56	22-1/2 x 16-3/8
2440V	2.98	22-1/4 x 19-5/16	2.91	22-1/2 x 18-5/8	3.03	22-1/2 x 19-3/8
2446V	3.45	22-1/4 x 22-5/16	3.38	22-1/2 x 22-5/8	3.50	22-1/2 x 22-3/8
2450V	3.91	22-1/4 x 25-5/16	3.85	22-1/2 x 24-5/8	3.96	22-1/2 x 25-3/8
2452V	4.07	22-1/4 x 26-5/16	4.0	22-1/2 x 25-5/8	4.12	22-1/2 x 26-3/8
2456V	4.37	22-1/4 x 28-5/16	4.32	22-1/2 x 27-5/8	4.43	22-1/2 x 28-3/8
2460V	4.84	22-1/4 x 31-5/16	4.79	22-1/2 x 30-5/8	4.90	22-1/2 x 31-3/8
2830V	2.43	26-1/4 x 13-5/16	2.32	26-1/2 x 12-5/8	2.46	26-1/2 x 13-3/8
2836V	2.97	26-1/4 x 16-5/16	2.88	26-1/2 x 15-5/8	3.01	26-1/2 x 16-3/8
2840V	3.52	26-1/4 x 19-5/16	3.43	26-1/2 x 18-5/8	3.57	26-1/2 x 19-3/8
2846V	4.07	26-1/4 x 22-5/16	3.98	26-1/2 x 22-5/8	4.12	26-1/2 x 22-3/8
2850V	4.61	26-1/4 x 25-5/16	4.53	26-1/2 x 24-5/8	4.67	26-1/2 x 25-3/8
2852V	4.80	26-1/4 x 26-5/16	4.72	26-1/2 x 25-5/8	4.85	26-1/2 x 26-3/8
2856V	5.16	26-1/4 x 28-5/16	5.08	26-1/2 x 27-5/8	5.22	26-1/2 x 28-3/8
2860V	5.71	26-1/4 x 31-5/16	5.64	26-1/2 x 30-5/8	5.77	26-1/2 x 31-3/8
3030V	2.80	30-1/4 x 13-5/16	2.67	30-1/2 x 12-5/8	2.83	30-1/2 x 13-3/8
3036V	3.43	30-1/4 x 16-5/16	3.31	30-1/2 x 15-5/8	3.47	30-1/2 x 16-3/8
3040V	4.06	30-1/4 x 19-5/16	3.94	30-1/2 x 18-5/8	4.10	30-1/2 x 19-3/8
3046V	4.69	30-1/4 x 22-5/16	4.58	30-1/2 x 22-5/8	4.74	30-1/2 x 22-3/8
3050V	5.32	30-1/4 x 25-5/16	5.22	30-1/2 x 24-5/8	5.37	30-1/2 x 25-3/8
3052V	5.53	30-1/4 x 26-5/16	5.43	30-1/2 x 25-5/8	5.59	30-1/2 x 26-3/8
3056V	5.95	30-1/4 x 28-5/16	5.85	30-1/2 x 27-5/8	6.01	30-1/2 x 28-3/8
3060V	6.58	30-1/4 x 31-5/16	6.49	30-1/2 x 30-5/8	6.65	30-1/2 x 31-3/8
3240V	4.33	32-1/4 x 19-5/16	4.2	32-1/2 x 18-5/8	4.37	32-1/2 x 19-3/8
3246V	5.00	32-1/4 x 22-5/16	4.88	32-1/2 x 22-5/8	5.05	32-1/2 x 22-3/8
3250V	5.67	32-1/4 x 25-5/16	5.56	32-1/2 x 24-5/8	5.73	32-1/2 x 25-3/8
3252V	5.89	32-1/4 x 26-5/16	5.78	32-1/2 x 25-5/8	5.95	32-1/2 x 26-3/8

Sizes shaded in grey have a 5.70 sq. ft. clear opening or better. Check with your local building department for egress requirements.

