



HARVEY
WINDOWS + DOORS

ENTRY DOORS



2024 CATALOG



Introducing a *NEW*
ENTRY DOOR SYSTEM
from **HARVEY®**

CONTENTS

About Harvey Entry Doors	4
Trusted Partners	5
Quality Fiberglass Doors	6
Series Overview	7
High Performance Jambs	8
Configuration and Components	9
Doorlite Frames	10
Blinds Between Glass	11
Glass Options	12
Premium Finishes	14
Entry Door Hardware	16
Panolock®	18
Keyless Entry Systems	19
<u>Traditional Series Overview</u>	20
Smooth	23
Oak & Mahogany	38
<u>Craftsman Series Overview</u>	42
Smooth	44
Fir	48
<u>Modern Series Overview</u>	50
Smooth	51
Brushed Smooth	53
<u>Specialty Series Fire Doors</u>	56
Warranty	57
Door Opening Dimensions	58

YOUR PARTNER FOR ENTRY DOOR SYSTEMS



With 60 years of industry experience, Harvey Windows + Doors is highly selective with the products that we sell to our customers. Focusing on long-term value for the homeowner and reliability for the contractor, we've created a line of entry door products that combine aesthetic appeal with exceptional durability and performance.

Harvey's entry door system offers the longevity of fiberglass with the beauty and versatility long associated with wood doors. Featuring curated components from trusted partners, entryways can be fully customized from configuration to glass selection to pre-finishing. And since it's a Harvey entry door, you'll rest easy knowing you have a product backed by our legendary service and deep commitment to quality.

COMPONENTS FROM LEADING SUPPLIERS

Pairing your Harvey windows with our entry doors just make sense, especially when you consider the well-known vendor partnerships that support the components of our door system.



FIBERGLASS SLABS

Plastpro is our partner for fiberglass door slabs. Since 1994, this brand has been a firm believer in providing a superior fiberglass door with the best value, technology, and commitment to customers. They are an industry leader with high-quality solutions that are impervious to weather damage. Plastpro fiberglass slabs outperform other door options and require less maintenance.

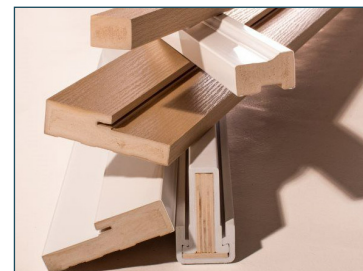

COMPOSITE JAMBS

Dura-Plast™, a subsidiary of GM Wood Products, is Harvey's composite frame supplier. Dura-Plast frames are made with a high-performance blend of PVC and wood flour that withstands warping and splitting. They are considered one of the best-performing, no-compromise composite door frame systems vendors on the market.



PAINT AND STAIN

Sherwin-Williams is our partner for paint colors and stains. Founded in 1866, they have spent the last 155+ years creating a legacy of growth, creativity, and innovation to meet the needs of their growing global customer base.



GLASS AND LITE FRAMES

ODL® is Harvey's partner for decorative glass inserts and lite frames. They are an industry leader with a team of innovators and problem-solvers willing to take creative risks. ODL has been family-run for three generations, founded with the intention of creating products that truly make their customers' lives better. This guiding principle rings true today with the high-quality products and services that they offer.

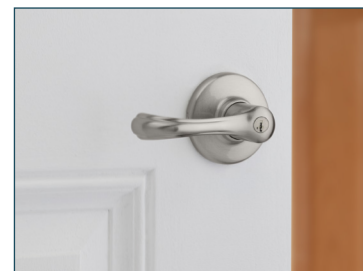

HARDWARE AND SMART LOCKS

For over a century, Schlage® has provided durable door hardware in diverse designs and finishes, catering to every style from classic to contemporary. Similarly, Kwikset®, with over 75 years of expertise, offers quality entry door hardware ranging from modern sophistication to classic simplicity, ensuring a perfect match for any aesthetic.

QUALITY PLASTPRO® FIBERGLASS DOORS

Plastpro's HydroShield Technology protects doors against moisture and humidity infiltration by creating a fully composite barrier that encases and protects the door on all six sides.

It prevents warping, delamination, corrosion, rotting, and the buildup of mold and mildew.

1 FIBERGLASS REINFORCED SKINS

Skins are produced to the highest quality, requiring little maintenance and will not splinter, dent, warp, rot, or rust. Choose a door skin from a variety of grains that can be painted or stained.

2 FULL LENGTH COMPOSITE STILES

Full-length composite stiles protect the door from external moisture to prevent warping or rotting, with twice the screw-holding strength of wood.

3 COMPOSITE TOP & BOTTOM RAILS

High-strength, composite top and bottom rails prevent moisture from seeping into the door and prevent the buildup of mold.

4 EXTENDED LOCKBLOCK

Full-length LVL allows any type of lock to be placed for increased security.

5 POLYURETHANE FOAM CORE

Advanced CFC-free, high density, Polyurethane foam core enhances the door's soundproofing capabilities and provides insulation up to six times greater than wood doors.

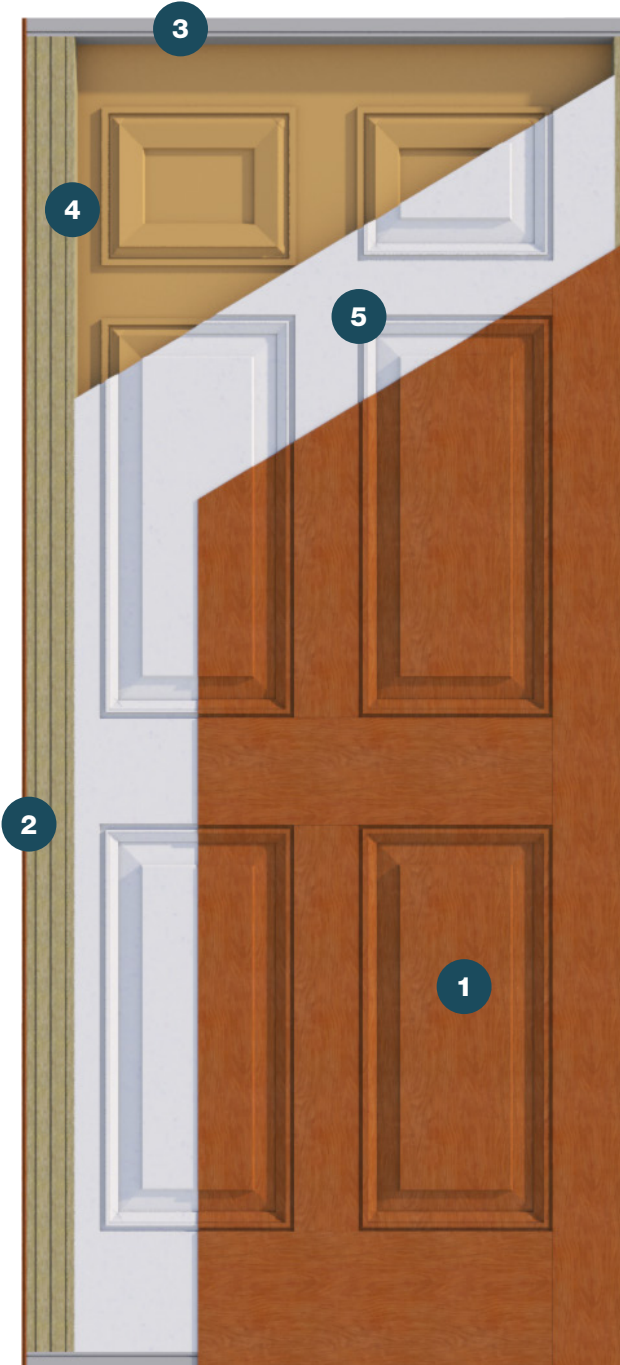

WATCH FEATURE OVERVIEW VIDEO



SERIES OVERVIEW



TRADITIONAL

Our largest selection of doors, the Traditional Series gives you the choice of Smooth textured doors for a polished look, or the look of real wood with Oak and Mahogany grains.



CRAFTSMAN

The Craftsman Series blends historical elegance with contemporary design, featuring architecturally-inspired doors bolstered by modern engineering.



MODERN

Refresh your entryway with the clean lines, unique lite configurations, and large expanses of glass. This series includes select styles available with the ONYX finish.



SPECIALTY

Fire Rated doors are made with fire-resistant composite creating an extremely durable entryway.

SLAB TEXTURES

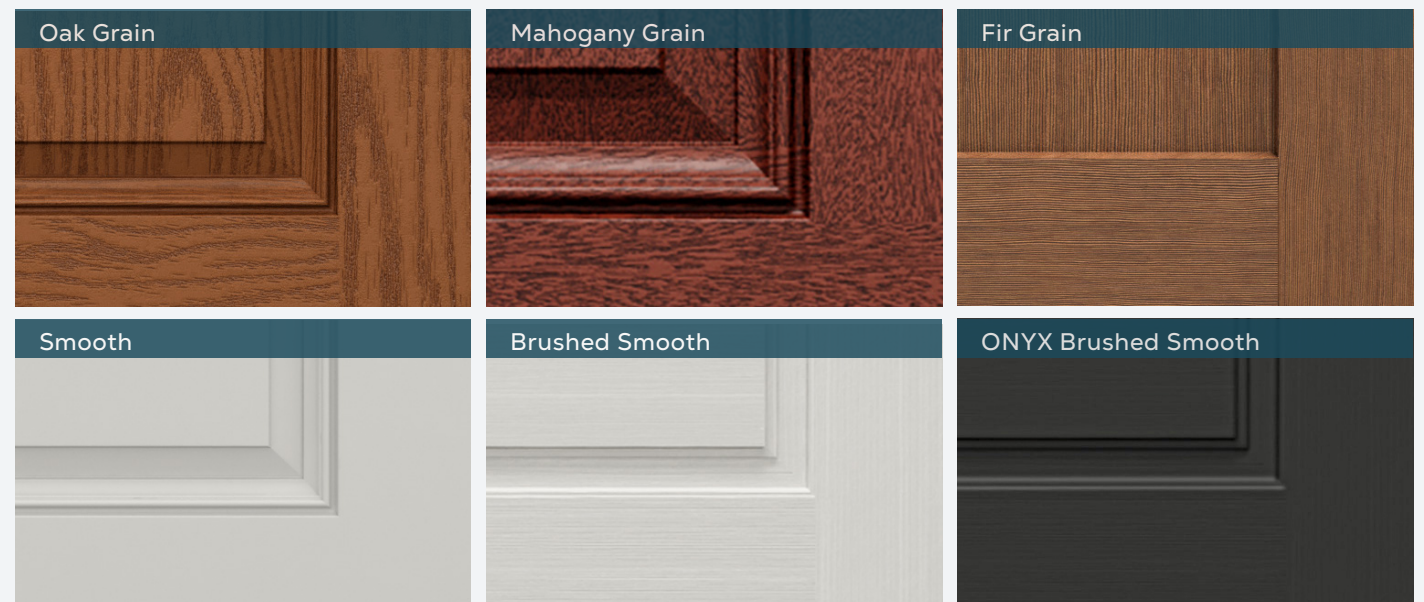

HIGH PERFORMANCE JAMBS



WORRY-FREE COMPOSITE FRAMES

Available in Wood Grain and White Vinyl Clad, Dura-Plast™ is a poly-fiber door frame system that combines the strength and convenience of wood with enhanced properties that prevents moisture, rot, and insect damage. With Harvey, frames can be pre-finished to match or contrast your door.



WHY COMPOSITE FRAMES?

Closed cellular structure ensures door frame and molding will not absorb or wick moisture, and prevents warping, rotting, and splitting, with twice the screw-holding power of traditional wood door frames. The rigid Poly-Fiber formulation eliminates the need for an aluminum support channel.

Available in white vinyl clad composite and wood grain composite are available in 4-9/16", 5-1/4", 6-9/16" and 7-1/4" jamb depths with Bronze weatherstripping.

DURA-FRAME™ PFJ JAMBS

Dura-Frame features Alaskan Yellow Cypress, one of the planet's most durable rot and insect resistant woods, which is finger-jointed to the bottom of premium pine frame component.

Sealed ends prohibit moisture from entering the substrate, ensuring longevity of frame component.

ACCESSORY AND COMPONENT OPTIONS

When it comes to accessories and components, Harvey gives you flexibility to configure the perfect entry with our range of accessories and components.

GRIDS

--	--

EXTERIOR CASING

--	--	--	--	--

KICKPLATES

--	--

MAILSLOTS

--	--

PEEPSITES

--	--

INSWING SILLS

--	--	--

OUTSWING SILLS

--	--

SILL ACCESSORIES

--	--	--

HINGES

--	--	--

DOORLITE FRAMES



ZEEL® FRAME

A MINIMAL DESIGN WITH ENDLESS OPPORTUNITIES

ZEEL is a sleek, versatile frame designed to be stained or painted that blends seamlessly into the entry door, allowing the doorglass to take center stage. This clean, low-profile look offers an alternative to direct glazed doors that provides the benefits of a frame system with the style homeowners desire.

Traditional frames can warp when subject to severe temperature changes or direct sunlight exposure, especially when painted dark colors. FiberMate Plus® is our strongest material yet and exceeds performance expectations in extreme environments.

Resolve® sealant is immune to squeeze out and doesn't degrade over time, reducing service calls and warranty issues. This clean thermoset foam seal can be repositioned and stays consistent over time.

ZEEL eliminates the need for screws and cumbersome screw hole covers with an innovative clip system. This allows each frame to sit flush, streamlining installation and greatly reducing installation time and effort. This efficient installation offers an alternative to costly flush glazed doors.

EVOLVE® FRAME

The Evolve frame provides superior rigidity and eliminates bothersome squeeze-out through the use of Resolve™ sealant. This latest innovation reduces scalloping, corner flare, and warping.

- Auto-aligning and self-seating screw hole covers
- SolarShield White (no finishing required)
- FiberPro® Oak (easy to paint or stain)

BLINDS BETWEEN GLASS

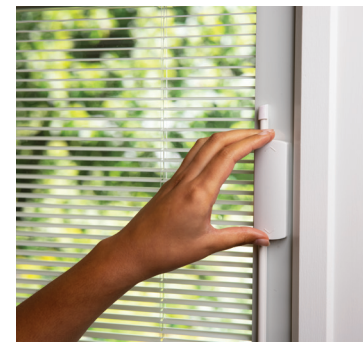

SMART PRIVACY CONTROL

Enclosed Blinds bring an updated look, feel and finish to your entryway while keeping the same benefits of maintenance-free light and privacy control of enclosed blinds. This latest design combines easy operating effort and long-lasting reliability that continues our over 20-year history of building the best-selling blinds between glass in the industry.

TRIPLE GLAZED ENCLOSED BLINDS WITH GRIDS BETWEEN GLASS

These enclosed blinds are a perfect choice for people who value energy savings and quiet. The triple-glazed design with Low-E glass option reduces heat transmission by up to 28 percent and carries a 34 STC (Sound Transmission Coefficient) rating for sound suppression.

Beyond the comforts and practicalities of a triple-glazed doorglass lie stylish details, with the grids adding a warm aesthetic. The blind slats disappear behind the valance when they are fully raised for a clean, finished look. Blinds tilt and raise and lower the entire length of the door glass.

ODL is leading the industry in enclosed blinds that reduce the safety risk for children and pets. With no dangling cords, our blinds have received two certifications from the Window Covering Manufacturers Association and Parents for Window Blind Safety.



PRIVACY AND DECORATIVE GLASS OPTIONS

From grandiose camed designs to elegant privacy glass, our decorative door glass is engineered and crafted to be exactly what your home needs.



LOW-E PRIVACY GLASS

CUMULUS

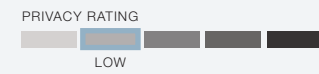

RAIN

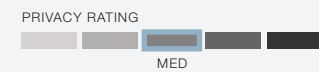
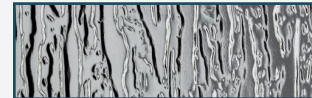

CHINCHILLA

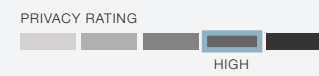

BLANCA

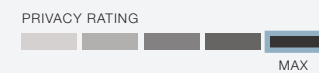
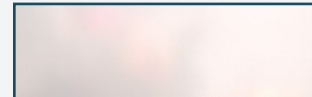

MICRO-GRANITE

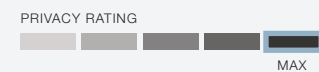

DECORATIVE GLASS



NOUVEAU

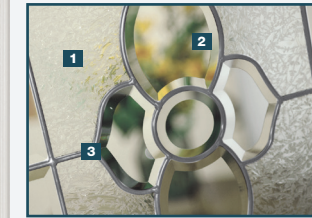
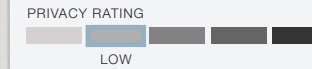

1. GLUE CHIP GLASS
2. CLEAR BEVELS
3. PLATINUM NICKEL CAMING

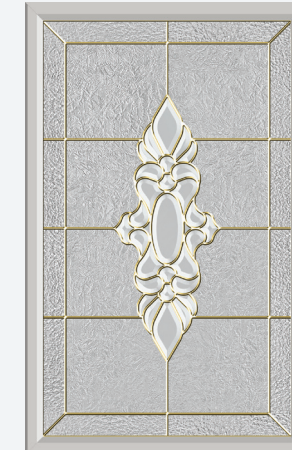

HEIRLOOMS

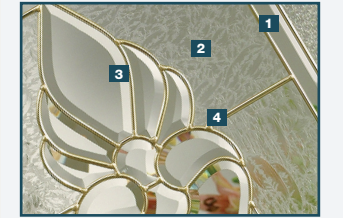

1. GRANITE GLASS
2. GLUE CHIP GLASS
3. CLEAR BEVELS
4. BRASS CAMING

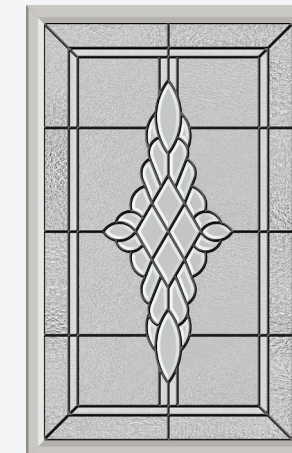

GRACE

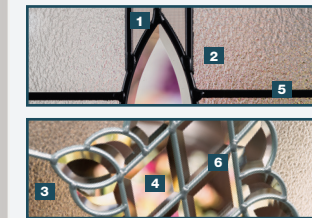
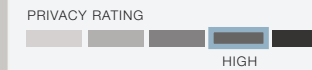

1. MICRO-CUBED GLASS
2. GRANITE GLASS
3. MICRO-GRANITE GLASS
4. CLEAR BEVELS
5. PATINA CAMING
6. SATIN NICKEL CAMING

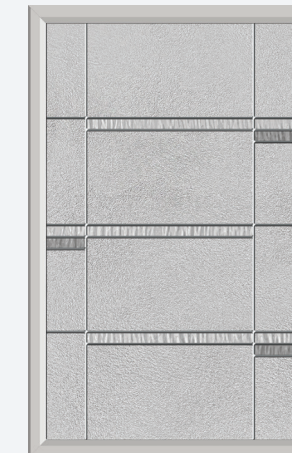

CROSSWALK

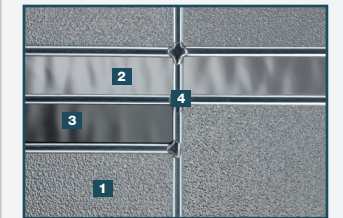
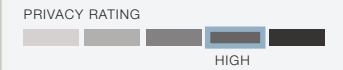

1. MICRO-ICED GRANITE GLASS
2. CLEAR SOFT WAVE GLASS
3. GRAY SOFT WAVE GLASS
4. PLATINUM NICKEL CAMING

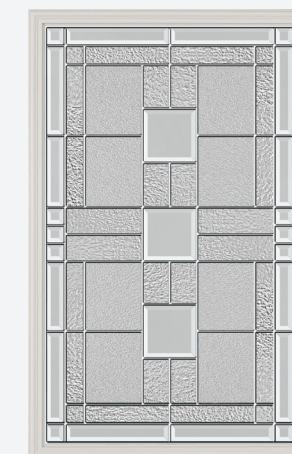

MONTEREY

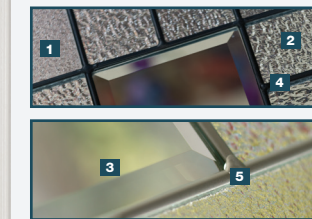
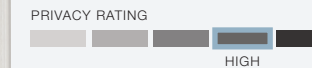

1. MICRO-GRANITE GLASS
2. GRANITE GLASS
3. CLEAR BEVELS
4. PATINA CAMING
5. SATIN NICKEL CAMING

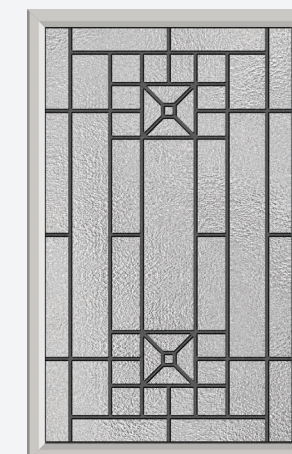

COURTYARD

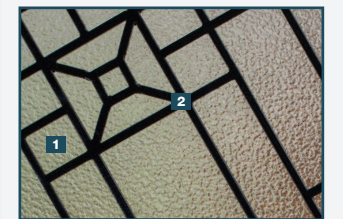
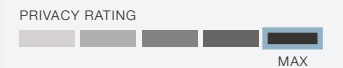

1. GRANITE GLASS
2. WROUGHT IRON CAMING



PREMIUM FINISHES

PRE-FINISHED STAIN OPTIONS

Sherwin-Williams® TruStain Waterborne Topcoat is an exterior grade, pigmented topcoat, designed to add durable color and finish to fiberglass doors.

We offer a variety of stain colors that enhance the look of our wood grain textured doors.



PRE-FINISHED PAINT OPTIONS

Our state-of-the-art process produces a resilient and durable finish that can't be duplicated in the field. We use an environmentally friendly, water-based finish with a very low solvent content that provides proven durability in all weather conditions. Additional benefits include lasting color vibrancy, expanded color and finish retention, and high abrasion and humidity resistance. All of our finishes are backed by a 10-year warranty.

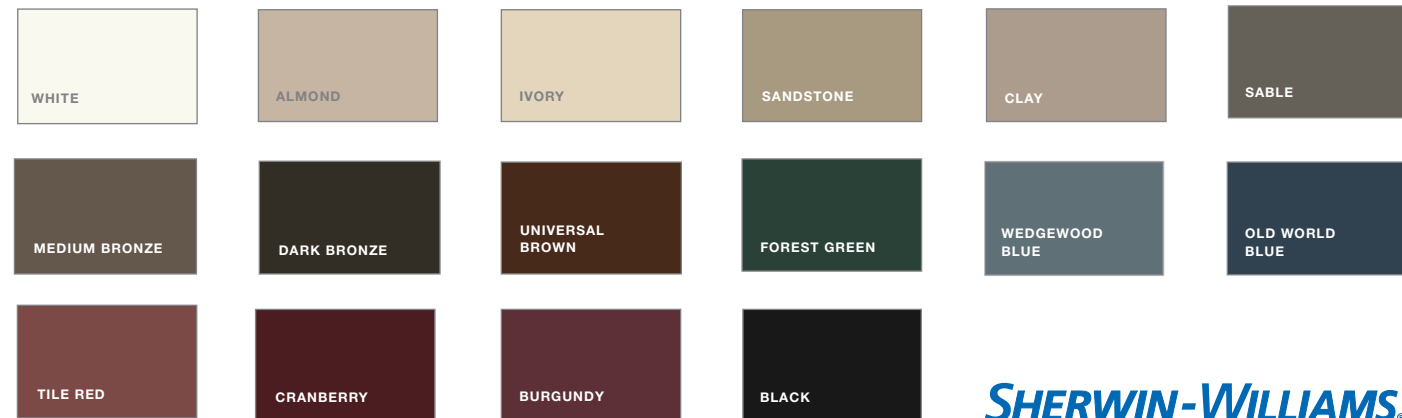

SHERWIN-WILLIAMS

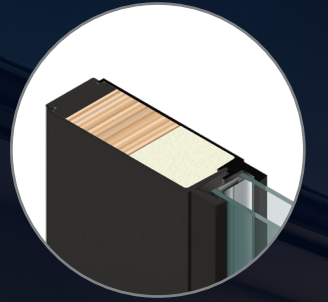

ONYX pigment permeates the entire door skin to help prevent chipping and the durability of fiberglass reduces dents and scratches.



plastpro® INFINITE FINISH

With pigmented fiberglass, the color stays put because it's built into your door. Enhanced pigmented fiberglass gives you enduring and impactful color without the frequent need to touch up painting.

























Get the modern aesthetic of your dreams with the contemporary look of a black door with ONYX Finish in one of our Modern Series direct glazed styles.



ENTRY DOOR HARDWARE

From classic to modern, Harvey has durable door hardware from leading brands Schlage® and Kwikset® in a variety of designs and finishes.

































HANDLESETS

	ARLINGTON KWIKSET			TAVARIS KWIKSET	
	CHELSEA KWIKSET			ADDISON SCHLAGE	
	HAWTHORNE KWIKSET			BROOKSHIRE SCHLAGE	
	MONTARA KWIKSET			CAMELOT SCHLAGE	
	PRESCOTT KWIKSET			CENTURY SCHLAGE	
	SAN CLEMENTE KWIKSET			PLYMOUTH SCHLAGE	





























HANDLESETS, LEVERS AND KNOBS













KNOBS

	ABBEY KWIKSET			
	HANCOCK KWIKSET			
	PISMO KWIKSET			
	BELL SCHLAGE			
	GEORGIAN SCHLAGE			
	ORBIT SCHLAGE			
	PLYMOUTH SCHLAGE			
	SIENNA SCHLAGE			

LEVERS

	DORIAN KWIKSET			
	HALIFAX KWIKSET			
	TUSTIN KWIKSET			
	ACCENT SCHLAGE			
	ELAN SCHLAGE			
	FLAIR SCHLAGE			
	JAZZ SCHLAGE			

KEY

 AB Aged Bronze	 BC Bright Chrome	 SC Satin Chrome	 K Keyed Entry
 AT Antique Brass	 LB Lifetime Bright Brass	 SN Satin Nickel	 P Passage Hardware Non-Locking
 BB/PB Standard Bright Brass SCHLAGE Polished Brass KWIKSET	 MB Matte Black	 VB Venetian Bronze	

PANOLOCK®+ MULTI-POINT LOCK

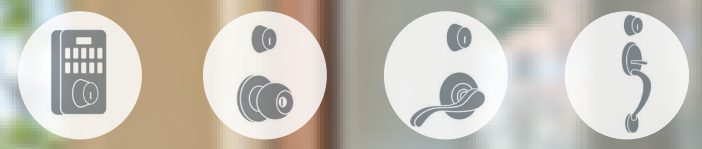
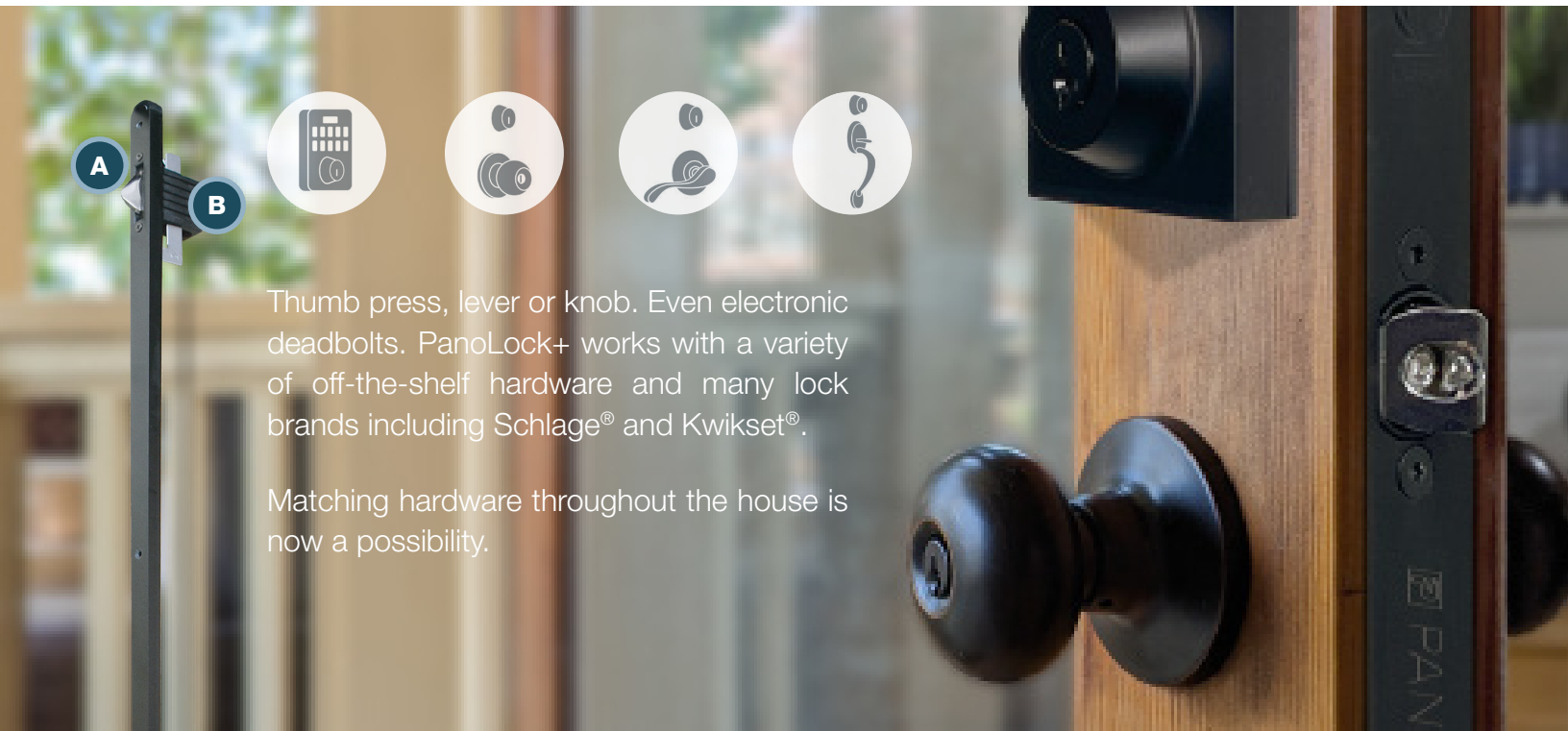

Thumb press, lever or knob. Even electronic deadbolts. PanoLock+ works with a variety of off-the-shelf hardware and many lock brands including Schlage® and Kwikset®.

Matching hardware throughout the house is now a possibility.

EASY TO LIVE WITH.

Unlike other locks that tend to catch, PanoLock+'s tapered bolts **A** engage easily, even when the door is out of alignment. A simple turn of the deadbolt operates both tapered bolts smoothly and the handle-set operates the handleset latch. PanoLock+ is easy to live with, even after years of use.

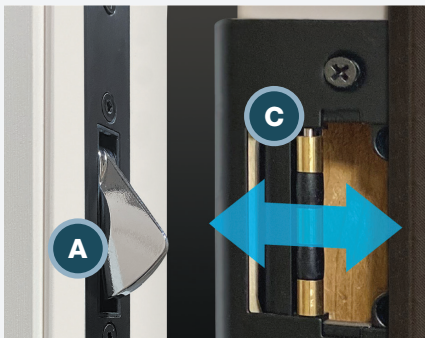

SECURE PERFORMANCE.

PanoLock+ delivers the strength of three locking points **B** for uncompromised protection. No weak hooks or catches. Just tested, proven strength.

THE PERFECT FIT.

Rollers **C** lower operating force and allow the tapered bolt to gently snug the door panel against the weatherstrip.

KEYLESS ENTRY SYSTEMS

Losing your house keys is a problem of the past with stylish and functional keyless entry options from industry leaders Schlage and Kwikset, featuring keypad, touch screen or fingerprint access.

SMART LOCKS Lock/unlock your door with the Bluetooth or WIFI connectivity options.

TOUCH SCREEN and FINGERPRINT ACCESS DEADBOLTS



CONNECTED KEYLESS LOCKS Secured keyless entry locks and coordinating handle options.

TOUCH SCREEN ACCESS DEADBOLTS and HANDLES

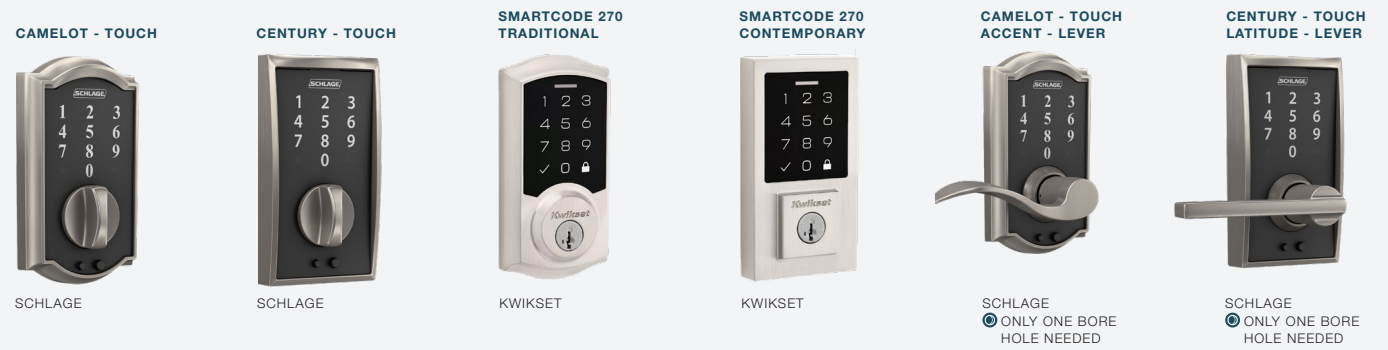

KEYPAD ACCESS DEADBOLTS and HANDLES



TRADITIONAL SERIES

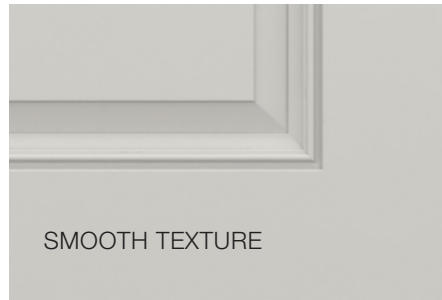

TRIED AND TRUE CLASSICS THAT ARE ALWAYS IN STYLE

The Traditional Series embodies elegance with styles that exude beauty and charm.

For a polished, neat look, our Smooth skin door styles are the perfect choice. Elevate your entryway with a selection from our range of 16 pre-finished paint options.

To infuse warmth and the natural look of wood into your home, explore our Oak and Mahogany textured door styles, available in six pre-finished stain options. With a variety of door and sidelite panel designs complemented by stylish decorative or privacy glass options, effortless sophistication is within reach.

PANEL OPTIONS

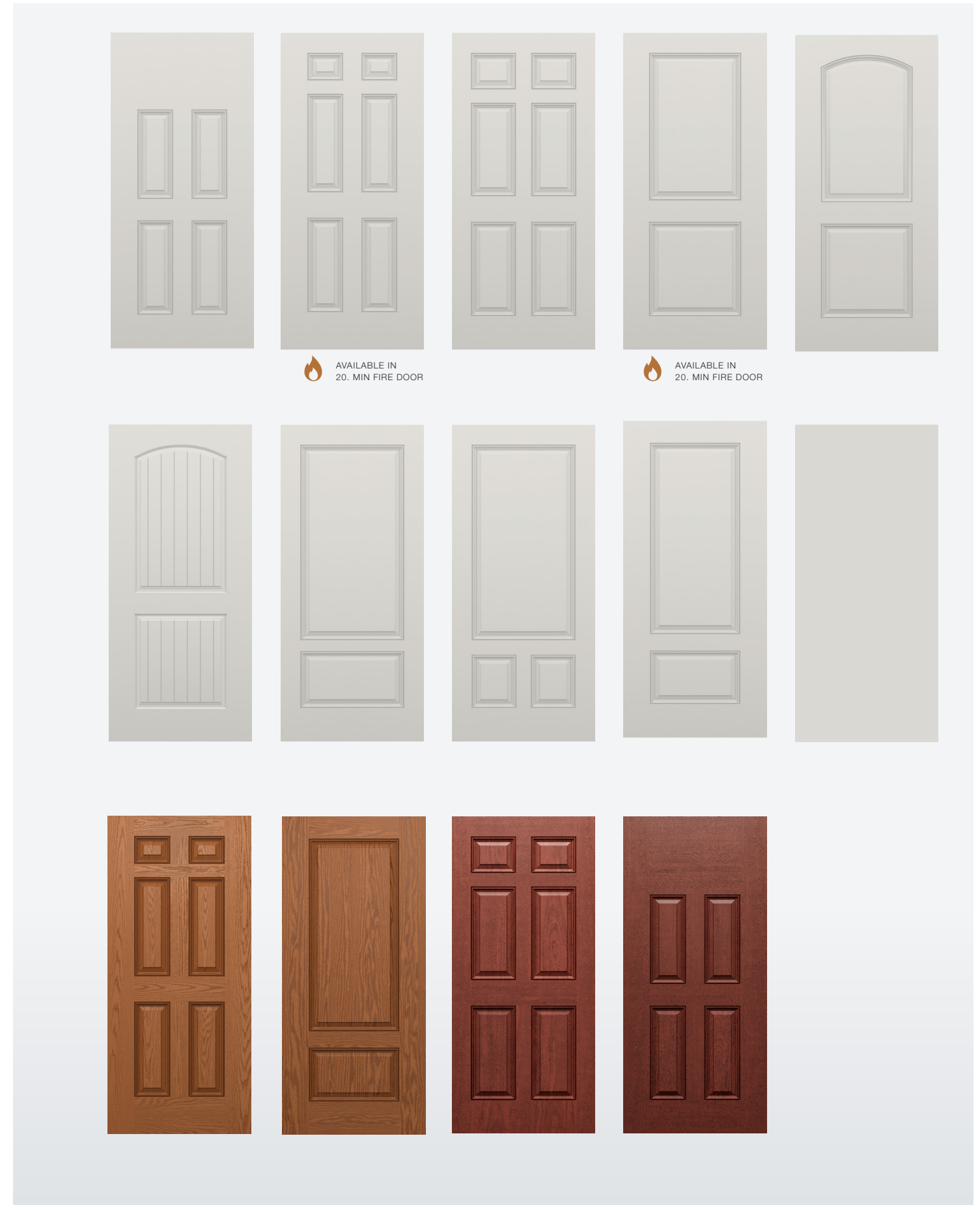



HALF LITE DOOR AND GLASS OPTIONS

CLEAR LOW-E GLASS FLUSH DOOR

ZF ▲	SF	ZF ▲ ◇	SF □ ◇	ZF □	ZF ▲ □
CLEAR LOW-E 2'8" x 6'8" 2'10" x 6'8" 3'0" x 6'8" 3'6" x 6'8"	VENTED LITE 2'8" x 6'8" 2'10" x 6'8" 3'0" x 6'8" 3'6" x 6'8"	INTERNAL BLINDS 2'8" x 6'8" 2'10" x 6'8" 3'0" x 6'8" 3'6" x 6'8"	INTERNAL BLINDS WITH GBG 2'8" x 6'8" 2'10" x 6'8" 3'0" x 6'8" 3'6" x 6'8"	CONTOUR GBG 2'8" x 6'8" 2'10" x 6'8" 3'0" x 6'8" 3'6" x 6'8"	CONTOUR GBG WITH GBG 2'8" x 6'8" 2'10" x 6'8" 3'0" x 6'8" 3'6" x 6'8"
ZF ■	ZF ▲ ■	ZF □	EF ■	ZF ■	ZF ■
FLAT GBG 2'8" x 6'8" 2'10" x 6'8" 3'0" x 6'8" 3'6" x 6'8"	FLAT GBG WITH GBG 2'8" x 6'8" 2'10" x 6'8" 3'0" x 6'8" 3'6" x 6'8"	FLAT PRAIRIE GBG 2'8" x 6'8" 2'10" x 6'8" 3'0" x 6'8" 3'6" x 6'8"	MOLDED SDL WITH GBG 2'8" x 6'8" 2'10" x 6'8" 3'0" x 6'8" 3'6" x 6'8"	APPLIED SDL WITH GBG 2'8" x 6'8" 2'10" x 6'8" 3'0" x 6'8" 3'6" x 6'8"	APPLIED SDL WITH GBG 2'8" x 6'8" 2'10" x 6'8" 3'0" x 6'8" 3'6" x 6'8"

PRIVACY LOW-E GLASS FLUSH DOOR

ZF ▲	ZF	ZF	ZF ▲	ZF	ZF
BLANCA 2'8" x 6'8" 2'10" x 6'8" 3'0" x 6'8" 3'6" x 6'8"	BLANCA WITH APPLIED SDL 2'8" x 6'8" 2'10" x 6'8" 3'0" x 6'8" 3'6" x 6'8"	BLANCA WITH APPLIED SDL 2'8" x 6'8" 2'10" x 6'8" 3'0" x 6'8" 3'6" x 6'8"	CHINCHILLA 2'8" x 6'8" 2'10" x 6'8" 3'0" x 6'8" 3'6" x 6'8"	CHINCHILLA WITH APPLIED SDL 2'8" x 6'8" 2'10" x 6'8" 3'0" x 6'8" 3'6" x 6'8"	CHINCHILLA WITH APPLIED SDL 2'8" x 6'8" 2'10" x 6'8" 3'0" x 6'8" 3'6" x 6'8"
ZF ▲	ZF	ZF	ZF ▲	ZF	ZF
CUMULUS 2'8" x 6'8" 2'10" x 6'8" 3'0" x 6'8" 3'6" x 6'8"	CUMULUS WITH APPLIED SDL 2'8" x 6'8" 2'10" x 6'8" 3'0" x 6'8" 3'6" x 6'8"	CUMULUS WITH APPLIED SDL 2'8" x 6'8" 2'10" x 6'8" 3'0" x 6'8" 3'6" x 6'8"	MICRO-GRANITE 2'8" x 6'8" 2'10" x 6'8" 3'0" x 6'8" 3'6" x 6'8"	MICRO-GRANITE WITH APPLIED SDL 2'8" x 6'8" 2'10" x 6'8" 3'0" x 6'8" 3'6" x 6'8"	MICRO-GRANITE WITH APPLIED SDL 2'8" x 6'8" 2'10" x 6'8" 3'0" x 6'8" 3'6" x 6'8"

KEY

▲ 2'6" x 6'8" size available with Evolve Frame
Glass = 20" x 36" for 2668
Glass = 22" x 36" for 2868, 21068, 3068, 3668

■ Black GBG
□ White GBG
■ Silver Spacer
◇ White Blinds

ZF Zeel Frame
EF Evolve Frame
SF Standard Frame

Door size depicted is 3068

TRADITIONAL SMOOTH

PRIVACY LOW-E GLASS FLUSH DOOR CONT.

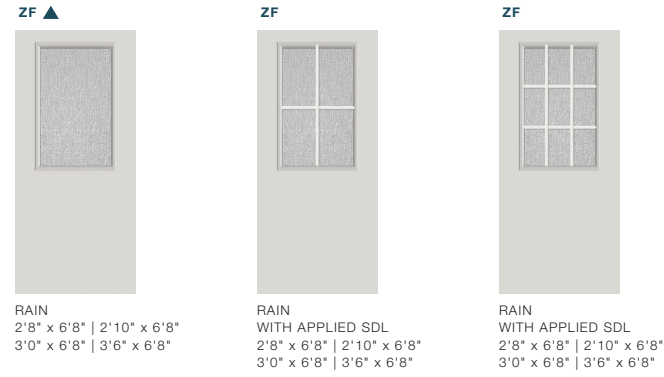

DECORATIVE GLASS FLUSH DOOR

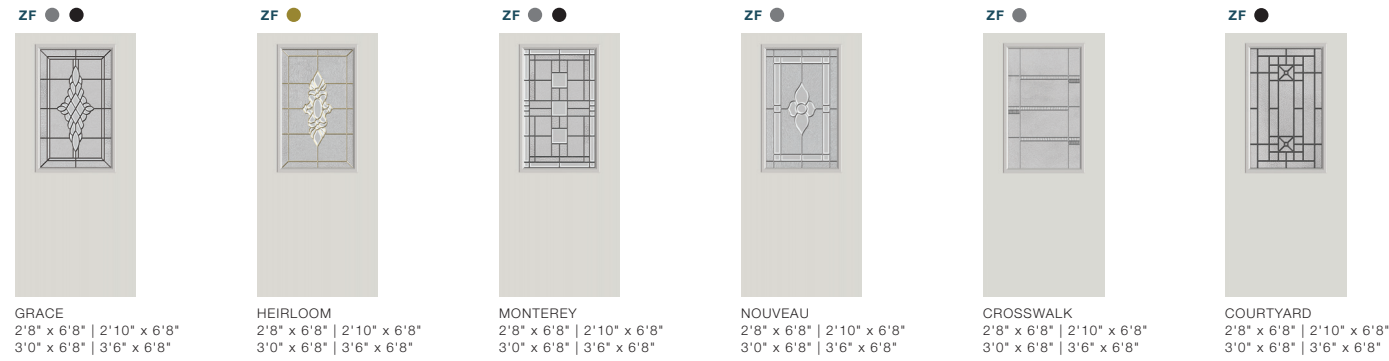

HALF LITE DOOR AND GLASS OPTIONS

CLEAR LOW-E GLASS 1-PANEL RAISED DOOR



PRIVACY LOW-E GLASS 1-PANEL RAISED DOOR



KEY

Glass = 22" x 36" for 2868 and 3068

- Black GBG
- White GBG
- Silver Spacer
- ◇ White Blinds

- Patina/Wrought Iron Caming
- Platinum/Satin Nickel Caming
- Brass Caming

- ZF** Zeel Frame
- EF** Evolve Frame
- SF** Standard Frame

Door size depicted is 3068

TRADITIONAL SMOOTH

PRIVACY LOW-E GLASS 1-PANEL RAISED DOOR



DECORATIVE GLASS 1-PANEL RAISED DOOR

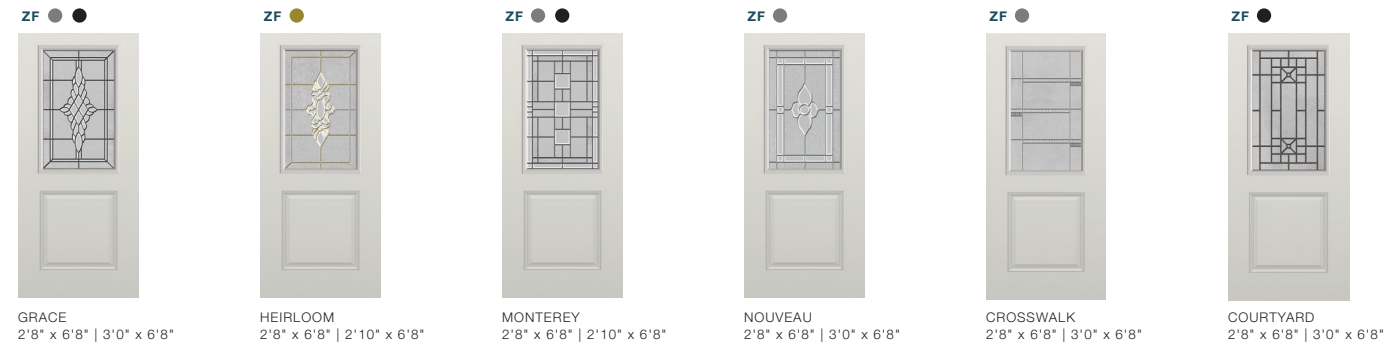

HALF LITE DOOR AND GLASS OPTIONS

CLEAR LOW-E GLASS 1-PANEL COTTAGE DOOR

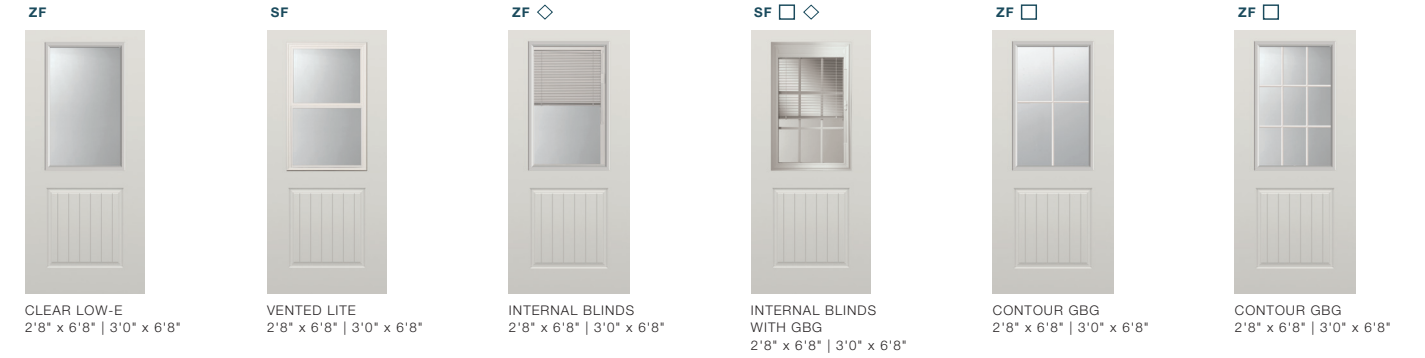

PRIVACY LOW-E GLASS 1-PANEL COTTAGE DOOR

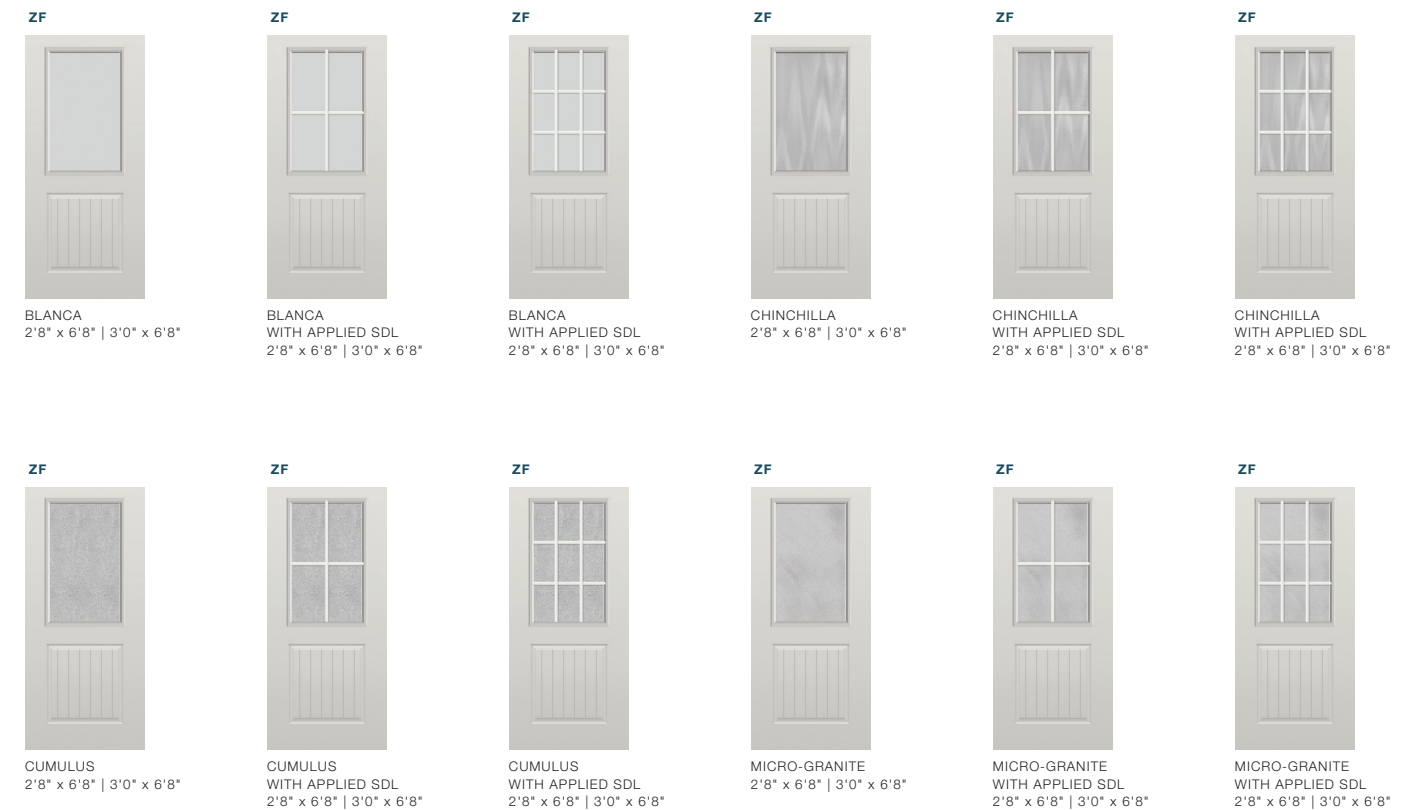

KEY

Glass = 22" x 36" for 2868 and 3068

- Black GBG
- White GBG
- Silver Spacer
- ◇ White Blinds

- Patina/Wrought Iron Caming
- Platinum/Satin Nickel Caming
- Brass Caming

- ZF Zeel Frame
- EF Evolve Frame
- SF Standard Frame

Door size depicted is 3068

TRADITIONAL SMOOTH

PRIVACY LOW-E GLASS 1-PANEL COTTAGE DOOR CONT.



DECORATIVE GLASS 1-PANEL COTTAGE DOOR

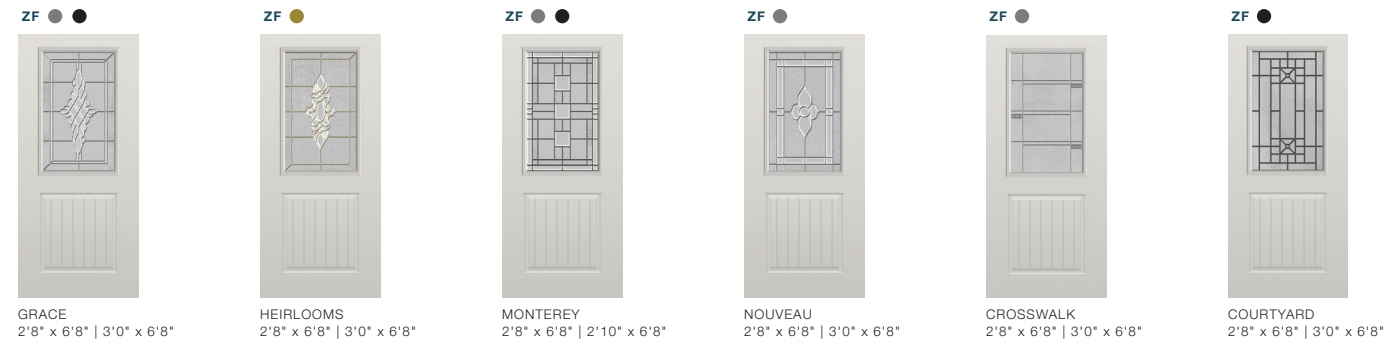

TOP LITE/HALF LITE DOORS AND GLASS OPTIONS

CLEAR GLASS 4-PANEL DOOR



CLEAR LOW-E GLASS 2-PANEL DOOR

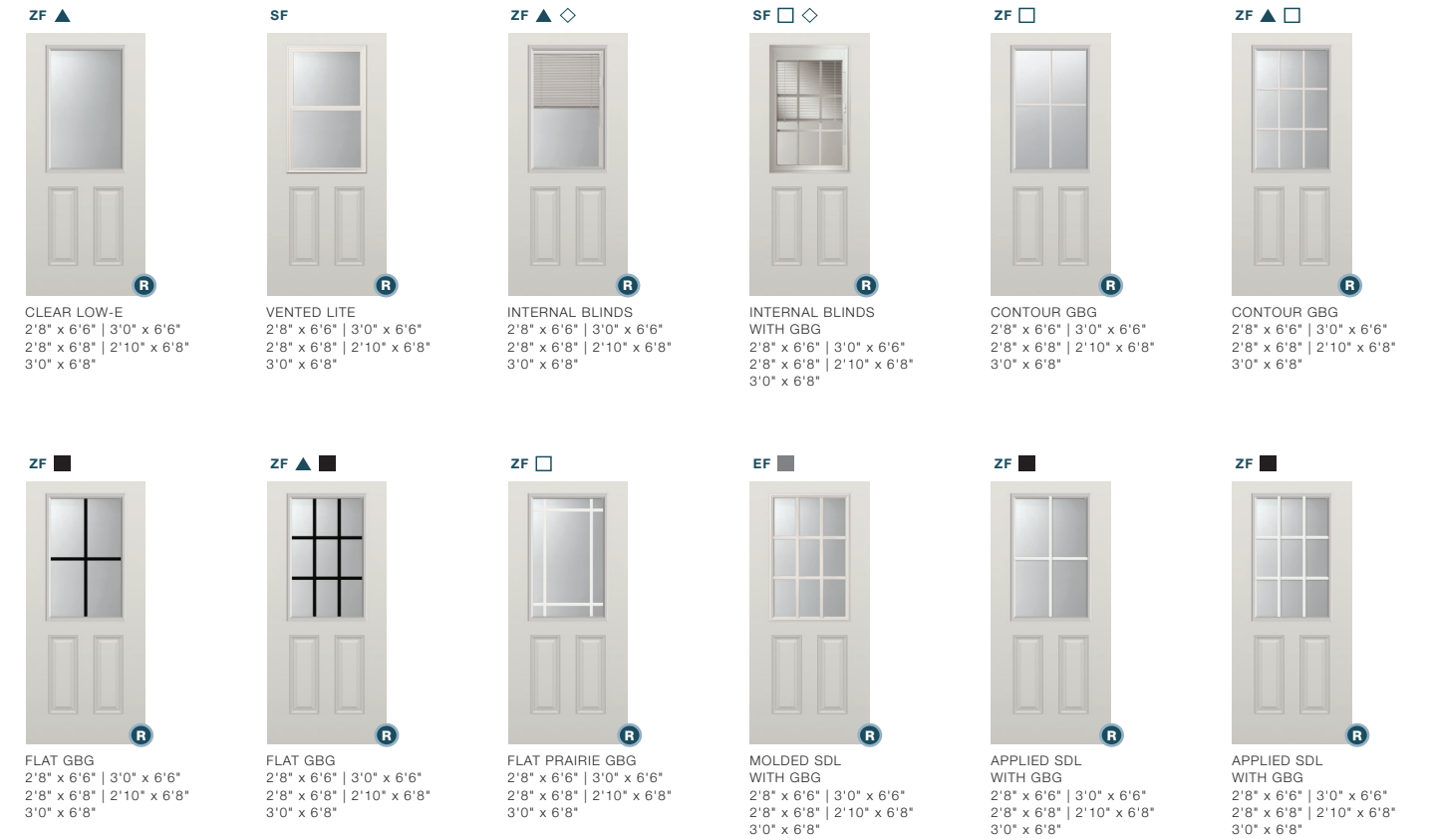

PRIVACY LOW-E GLASS 2-PANEL DOOR



KEY

- ▲ 2'6" x 6'8" size available with Evolve Frame
Glass = 20" x 36" for 2668
Glass = 22" x 36" for 2866, 2868, 21068, 3066, 3068
- 3068 reinforced option for closer/panic hardware

- Black GBG
- White GBG
- Silver Spacer
- ◇ White Blinds

- Patina/Wrought Iron Caming
- Platinum/Satin Nickel Caming
- Brass Caming

- ZF Zeel Frame
- EF Evolve Frame
- SF Standard Frame

Door size depicted is 3068







TRADITIONAL SMOOTH

PRIVACY LOW-E GLASS 2-PANEL DOOR CONT.

ZF ▲  CUMULUS 2'8" x 6'6" 3'0" x 6'6" 2'8" x 6'8" 2'10" x 6'8" 3'0" x 6'8"	ZF  CUMULUS WITH APPLIED SDL 2'8" x 6'6" 3'0" x 6'6" 2'8" x 6'8" 2'10" x 6'8" 3'0" x 6'8"	ZF  CUMULUS WITH APPLIED SDL 2'8" x 6'6" 3'0" x 6'6" 2'8" x 6'8" 2'10" x 6'8" 3'0" x 6'8"	ZF ▲  MICRO-GRANITE 2'8" x 6'6" 3'0" x 6'6" 2'8" x 6'8" 2'10" x 6'8" 3'0" x 6'8"	ZF  MICRO-GRANITE WITH APPLIED SDL 2'8" x 6'6" 3'0" x 6'6" 2'8" x 6'8" 2'10" x 6'8" 3'0" x 6'8"	ZF  MICRO-GRANITE WITH APPLIED SDL 2'8" x 6'6" 3'0" x 6'6" 2'8" x 6'8" 2'10" x 6'8" 3'0" x 6'8"
---	--	--	--	--	--





ZF ▲  RAIN 2'8" x 6'6" 3'0" x 6'6" 2'8" x 6'8" 2'10" x 6'8" 3'0" x 6'8"	ZF  RAIN WITH APPLIED SDL 2'8" x 6'6" 3'0" x 6'6" 2'8" x 6'8" 2'10" x 6'8" 3'0" x 6'8"	ZF  RAIN WITH APPLIED SDL 2'8" x 6'6" 3'0" x 6'6" 2'8" x 6'8" 2'10" x 6'8" 3'0" x 6'8"
--	---	---

DECORATIVE GLASS 2-PANEL DOOR





ZF ● ●  GRACE 2'8" x 6'6" 3'0" x 6'6" 2'8" x 6'8" 2'10" x 6'8" 3'0" x 6'8"	ZF ●  HEIRLOOMS 2'8" x 6'6" 3'0" x 6'6" 2'8" x 6'8" 2'10" x 6'8" 3'0" x 6'8"	ZF ●  MONTEREY 2'8" x 6'6" 3'0" x 6'6" 2'8" x 6'8" 2'10" x 6'8" 3'0" x 6'8"	ZF ●  NOUVEAU 2'8" x 6'6" 3'0" x 6'6" 2'8" x 6'8" 2'10" x 6'8" 3'0" x 6'8"	ZF ●  CROSSWALK 2'8" x 6'6" 3'0" x 6'6" 2'8" x 6'8" 2'10" x 6'8" 3'0" x 6'8"	ZF ●  COURTYARD 2'8" x 6'6" 3'0" x 6'6" 2'8" x 6'8" 2'10" x 6'8" 3'0" x 6'8"
---	--	---	--	--	--

HALF LITE SIDELITE AND GLASS OPTIONS

CLEAR LOW-E GLASS 1-PANEL SIDELITE

ZF  CLEAR LOW-E 12" x 6'8" 14" x 6'8"	ZF □  CONTOUR GBG 12" x 6'8" 14" x 6'8"	ZF ■  FLAT GBG 12" x 6'8" 14" x 6'8"	EF ■  MOLDED SDL 12" x 6'8" 14" x 6'8"	ZF ■  APPLIED SDL 12" x 6'8" 14" x 6'8"
---	---	--	--	---

PRIVACY LOW-E GLASS 1-PANEL SIDELITE

ZF  BLANCA 12" x 6'8" 14" x 6'8"	ZF  BLANCA WITH APPLIED SDL 12" x 6'8" 14" x 6'8"	ZF  CHINCHILLA 12" x 6'8" 14" x 6'8"	ZF  CHINCHILLA WITH APPLIED SDL 12" x 6'8" 14" x 6'8"	ZF  CUMULUS 12" x 6'8" 14" x 6'8"	ZF  CUMULUS WITH APPLIED SDL 12" x 6'8" 14" x 6'8"
--	--	--	--	---	---

ZF  MICRO-GRANITE 12" x 6'8" 14" x 6'8"	ZF  MICRO-GRANITE WITH APPLIED SDL 12" x 6'8" 14" x 6'8"	ZF  RAIN 12" x 6'8" 14" x 6'8"	ZF  RAIN WITH APPLIED SDL 12" x 6'8" 14" x 6'8"
---	---	--	--

DECORATIVE GLASS 1-PANEL SIDELITE

ZF ● ●  GRACE 12" x 6'8" 14" x 6'8"	ZF ●  HEIRLOOMS 12" x 6'8" 14" x 6'8"	ZF ●  NOUVEAU 12" x 6'8" 14" x 6'8"	ZF ●  CROSSWALK 12" x 6'8" 14" x 6'8"
---	---	---	---

KEY

- ▲ 2'6" x 6'8" size available with Evolve Frame
- Glass = 20" x 36" for 2668
- Glass = 22" x 36" for 2866, 2868, 21068, 3066, 3068
- Glass = 8" x 36" for Half Lite Sidelites
- 3068 reinforced option for closer/panic hardware

- Black GBG
- White GBG
- Silver Spacer

- Patina/Wrought Iron Caming
- Platinum/Satin Nickel Caming
- Brass Caming

- ZF Zeel Frame
- EF Evolve Frame

Door size depicted is 3068
Sidelite size depicted is 14"

TRADITIONAL SMOOTH

CLEAR LOW-E GLASS 1-PANEL DOOR

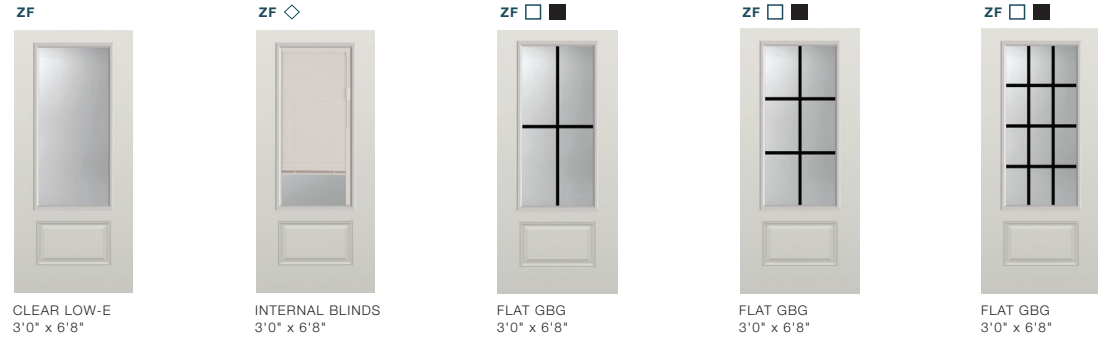

PRIVACY LOW-E GLASS 1-PANEL DOOR



3/4 LITE DOOR AND GLASS OPTIONS

PRIVACY LOW-E GLASS 1-PANEL DOOR CONT.

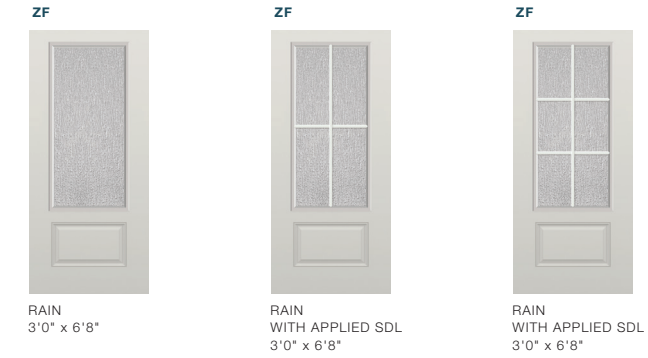

DECORATIVE GLASS 1-PANEL DOOR



CLEAR LOW-E / DECORATIVE GLASS 1-PANEL HERITAGE OVAL LITE DOOR



CLEAR LOW-E / DECORATIVE GLASS 2-PANEL ELITE OVAL LITE DOOR



KEY

Glass = 22" x 48" for Rectangle Glass
Glass = 16" x 40" for Oval Glass

◻ Black GBG
◻ White GBG
◻ Silver Spacer
◻ White Blinds

● Patina/Wrought Iron Caming
● Platinum/Satin Nickel Caming
● Brass Caming

ZF Zeel Frame
EF Evolve Frame
SF Standard Frame

Door size depicted is 3068

TRADITIONAL SMOOTH

CLEAR LOW-E GLASS 1-PANEL SIDELITE

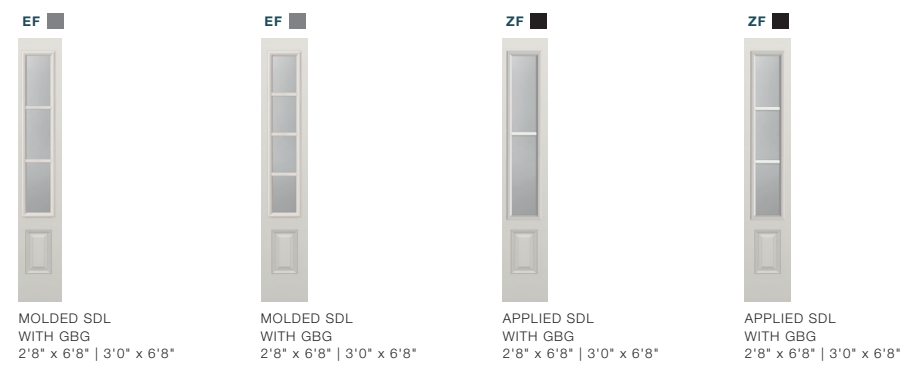
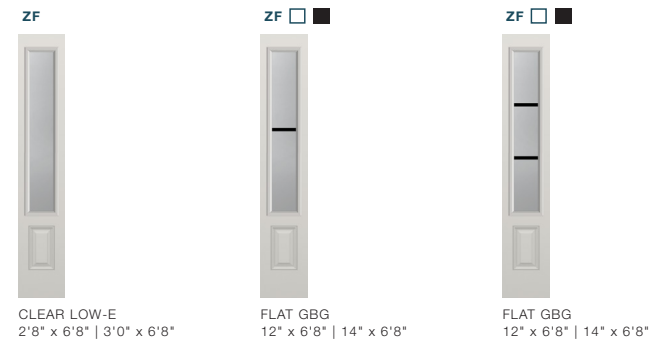

PRIVACY LOW-E GLASS 1-PANEL SIDELITE

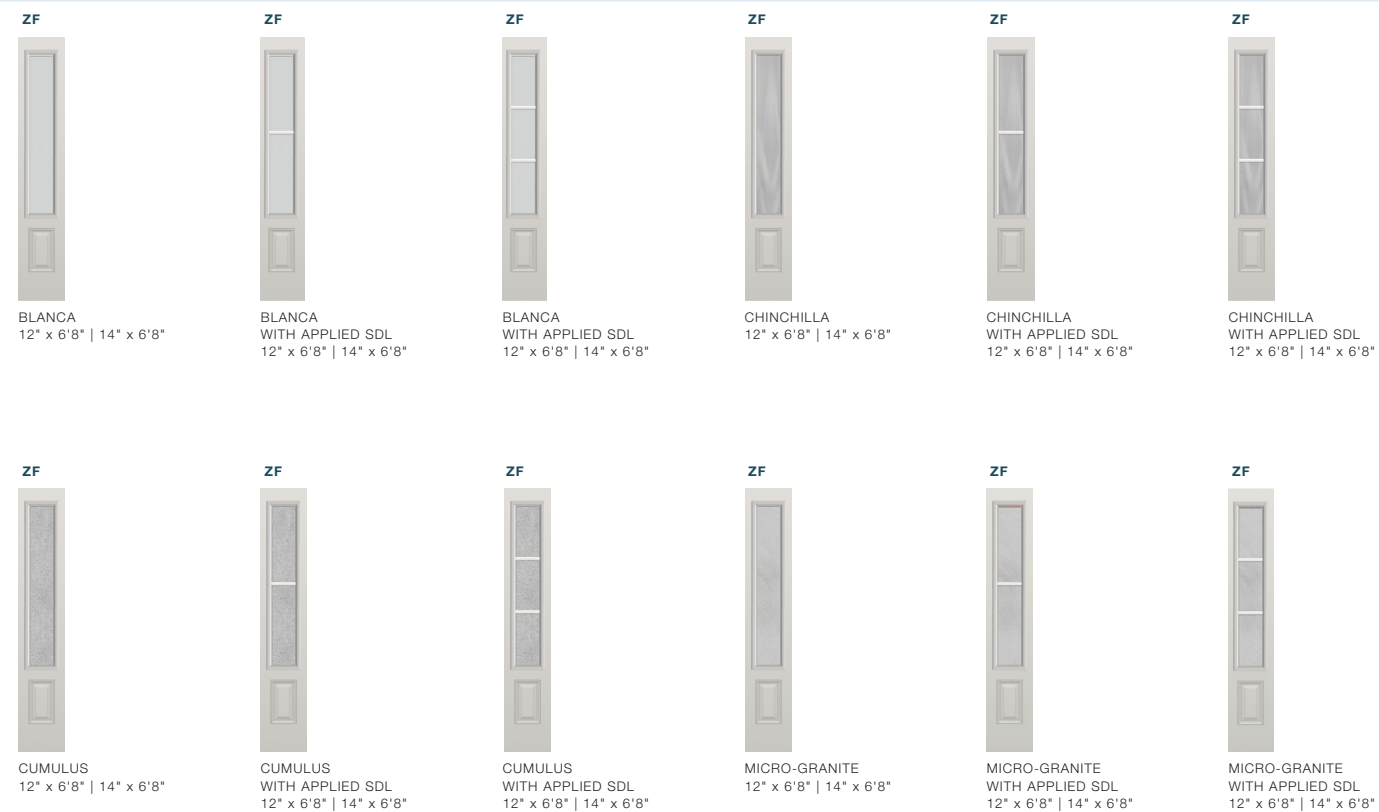

3/4 LITE SIDELITE AND GLASS OPTIONS

PRIVACY GLASS 1-PANEL SIDELITE CONT.



DECORATIVE GLASS 1-PANEL SIDELITE

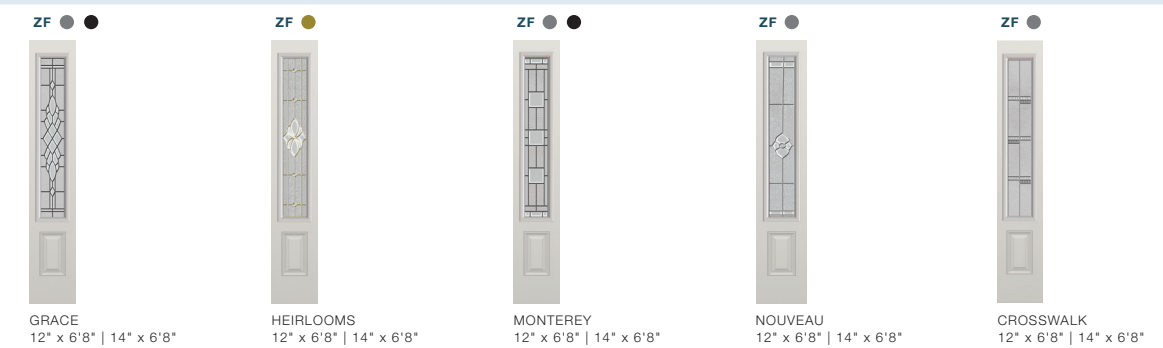

KEY

Glass = 8" x 48" for 3/4 Lite Sidelite

■ Black GBG
□ White GBG
■ Silver Spacer







● Patina/Wrought Iron Caming
● Platinum/Satin Nickel Caming
● Brass Caming

ZF Zeel Frame
EF Evolve Frame

Sidelite size depicted is 14"







TRADITIONAL SMOOTH

CLEAR LOW-E GLASS FULL LITE DOOR

ZF ▲  CLEAR LOW E 2'4" x 6'8" (Standard Frame) 2'8" x 6'6" 3'0" x 6'6" 2'6" x 6'8" 2'8" x 6'8" 2'10" x 6'8" 3'0" x 6'8" 3'6" x 6'8"	ZF ▲ ◇  INTERNAL BLINDS 2'8" x 6'6" 3'0" x 6'6" 2'6" x 6'8" 2'8" x 6'8" 2'10" x 6'8" 3'0" x 6'8" 3'6" x 6'8"	SF □ ◇  INTERNAL BLINDS WITH GBG 2'8" x 6'6" 3'0" x 6'6" 2'6" x 6'8" 2'8" x 6'8" 2'10" x 6'8" 3'0" x 6'8" 3'6" x 6'8"	ZF □  CONTOUR GBG 2'8" x 6'6" 3'0" x 6'6" 2'6" x 6'8" 2'8" x 6'8" 3'0" x 6'8" 3'6" x 6'8"	ZF ▲ □  CONTOUR GBG 2'8" x 6'6" 3'0" x 6'6" 2'6" x 6'8" 2'8" x 6'8" 2'10" x 6'8" 3'0" x 6'8" 3'6" x 6'8"	ZF ▲ ■  FLAT GBG 2'8" x 6'6" 3'0" x 6'6" 2'6" x 6'8" 2'8" x 6'8" 2'10" x 6'8" 3'0" x 6'8" 3'6" x 6'8"
--	---	--	---	---	--

ZF □  CLEAR LOW-E 2'8" x 6'6" 3'0" x 6'6" 2'6" x 6'8" 2'8" x 6'8" 3'0" x 6'8" 3'6" x 6'8"	EF ▲ ■  MOLDED SDL WITH GBG 2'8" x 6'6" 3'0" x 6'6" 2'6" x 6'8" 2'8" x 6'8" 2'10" x 6'8" 3'0" x 6'8" 3'6" x 6'8"	ZF ▲ ■  APPLIED SDL WITH GBG 2'8" x 6'6" 3'0" x 6'6" 2'6" x 6'8" 2'8" x 6'8" 2'10" x 6'8" 3'0" x 6'8" 3'6" x 6'8"
--	---	--







PRIVACY LOW-E GLASS FULL LITE DOOR

ZF ▲  BLANCA 2'8" x 6'6" 3'0" x 6'6" 2'6" x 6'8" 2'8" x 6'8" 2'10" x 6'8" 3'0" x 6'8" 3'6" x 6'8"	ZF ▲  BLANCA WITH APPLIED SDL 2'8" x 6'6" 3'0" x 6'6" 2'6" x 6'8" 2'8" x 6'8" 2'10" x 6'8" 3'0" x 6'8" 3'6" x 6'8"	ZF ▲  CHINCHILLA 2'8" x 6'6" 3'0" x 6'6" 2'6" x 6'8" 2'8" x 6'8" 2'10" x 6'8" 3'0" x 6'8" 3'6" x 6'8"	ZF ▲  CHINCHILLA WITH APPLIED SDL 2'8" x 6'6" 3'0" x 6'6" 2'6" x 6'8" 2'8" x 6'8" 2'10" x 6'8" 3'0" x 6'8" 3'6" x 6'8"	ZF ▲  CUMULUS 2'8" x 6'6" 3'0" x 6'6" 2'6" x 6'8" 2'8" x 6'8" 2'10" x 6'8" 3'0" x 6'8" 3'6" x 6'8"	ZF ▲  CUMULUS WITH APPLIED SDL 2'8" x 6'6" 3'0" x 6'6" 2'6" x 6'8" 2'8" x 6'8" 2'10" x 6'8" 3'0" x 6'8" 3'6" x 6'8"
---	---	--	---	---	--







ZF ▲  MICRO-GRANITE 2'8" x 6'6" 3'0" x 6'6" 2'6" x 6'8" 2'8" x 6'8" 2'10" x 6'8" 3'0" x 6'8" 3'6" x 6'8"	ZF ▲  MICRO-GRANITE WITH APPLIED SDL 2'8" x 6'6" 3'0" x 6'6" 2'6" x 6'8" 2'8" x 6'8" 2'10" x 6'8" 3'0" x 6'8" 3'6" x 6'8"	ZF ▲  RAIN 2'8" x 6'6" 3'0" x 6'6" 2'6" x 6'8" 2'8" x 6'8" 2'10" x 6'8" 3'0" x 6'8" 3'6" x 6'8"	ZF ▲  RAIN WITH APPLIED SDL 2'8" x 6'6" 3'0" x 6'6" 2'6" x 6'8" 2'8" x 6'8" 2'10" x 6'8" 3'0" x 6'8" 3'6" x 6'8"
--	--	--	---

FULL LITE DOOR / SIDELITE AND GLASS OPTIONS







CLEAR LOW-E GLASS FULL LITE SIDELITE

ZF  CLEAR LOW-E 10" x 6'8" 12" x 6'8" 14" x 6'8"	EF  INTERNAL BLINDS 10" x 6'8" 12" x 6'8" 14" x 6'8"	ZF □  CONTOUR GBG 10" x 6'8" 12" x 6'8" 14" x 6'8"	ZF ■  FLAT GBG 10" x 6'8" 12" x 6'8" 14" x 6'8"	EF ■  MOLDED SDL 10" x 6'8" 12" x 6'8" 14" x 6'8"	ZF  APPLIED SDL 10" x 6'8" 12" x 6'8" 14" x 6'8"
---	---	---	--	--	---





PRIVACY LOW-E GLASS FULL LITE SIDELITE

ZF  BLANCA 10" x 6'8" 12" x 6'8" 14" x 6'8"	ZF  BLANCA WITH APPLIED SDL 10" x 6'8" 12" x 6'8" 14" x 6'8"	ZF  CHINCHILLA 10" x 6'8" 12" x 6'8" 14" x 6'8"	ZF  CHINCHILLA WITH APPLIED SDL 10" x 6'8" 12" x 6'8" 14" x 6'8"	ZF  CUMULUS 10" x 6'8" 12" x 6'8" 14" x 6'8"	ZF  CUMULUS WITH APPLIED SDL 10" x 6'8" 12" x 6'8" 14" x 6'8"
--	---	--	---	---	--

PRIVACY LOW-E GLASS / DECORATIVE GLASS FULL LITE SIDELITE

ZF  MICRO-GRANITE 10" x 6'8" 12" x 6'8" 14" x 6'8"	ZF  MICRO-GRANITE WITH APPLIED SDL 10" x 6'8" 12" x 6'8" 14" x 6'8"	ZF  RAIN 10" x 6'8" 12" x 6'8" 14" x 6'8"	ZF  RAIN WITH APPLIED SDL 10" x 6'8" 12" x 6'8" 14" x 6'8"	ZF ● ●  GRACE 10" x 6'8" 12" x 6'8" 14" x 6'8"	ZF ●  HEIRLOOM 10" x 6'8" 12" x 6'8" 14" x 6'8"
---	--	--	---	---	--

DECORATIVE GLASS FULL LITE SIDELITE

ZF ● ●  MONTEREY 10" x 6'8" 12" x 6'8" 14" x 6'8"	ZF ●  NOUVEAU 10" x 6'8" 12" x 6'8" 14" x 6'8"	ZF ●  CROSSWALK 10" x 6'8" 12" x 6'8" 14" x 6'8"	ZF ●  COURTYARD 10" x 6'8" 12" x 6'8" 14" x 6'8"	ZF ●  BAYPOINT 10" x 6'8" 12" x 6'8" 14" x 6'8"
--	---	---	---	--

KEY

- ▲ 2'6" x 6'8" size available with Evolve Frame
Glass = 20" x 64" for 2668
Glass = 22" x 64" for 2866, 2868, 21068, 3066, 3068, 3668
Glass = 7" x 64" for Full Lite Sidelites
- Patina/Wrought Iron Caming
- Platinum/Satin Nickel Caming
- Brass Caming
- Black GBG
- White GBG
- Silver Spacer
- ◇ White Blinds
- ZF Zeel Frame
- EF Evolve Frame
- SF Standard Frame

Door size depicted is 3068
Sidelite size depicted is 14"

TRADITIONAL OAK & MAHOGANY

CLEAR LOW-E GLASS OAK DOORS



DECORATIVE GLASS OAK DOORS

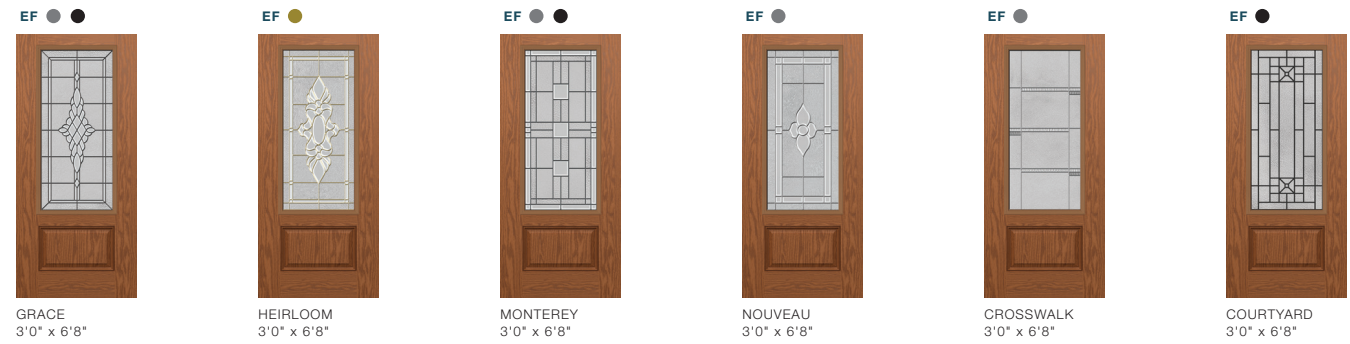
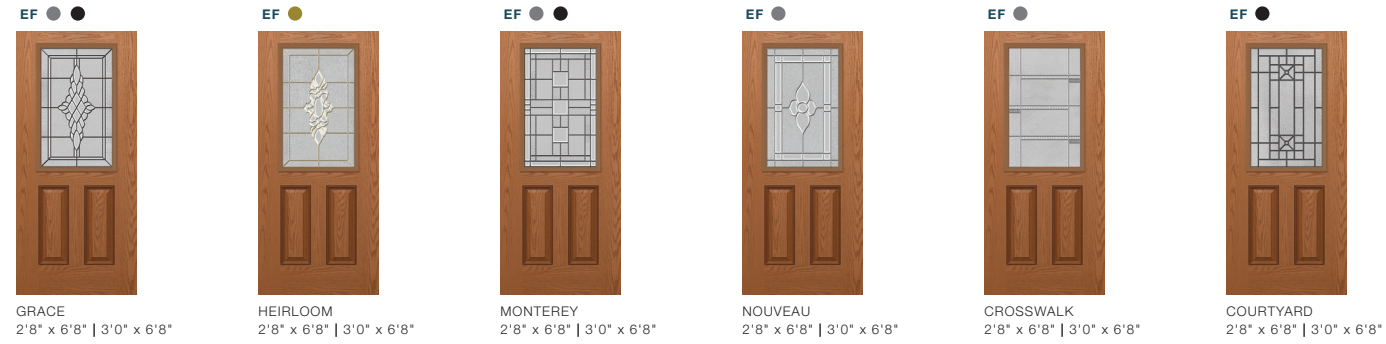

CLEAR LOW-E GLASS MAHOGANY DOORS



DOOR / SIDELITE AND GLASS OPTIONS

DECORATIVE GLASS MAHOGANY DOORS



CLEAR LOW-E GLASS OAK SIDELITES



DECORATIVE GLASS OAK SIDELITES

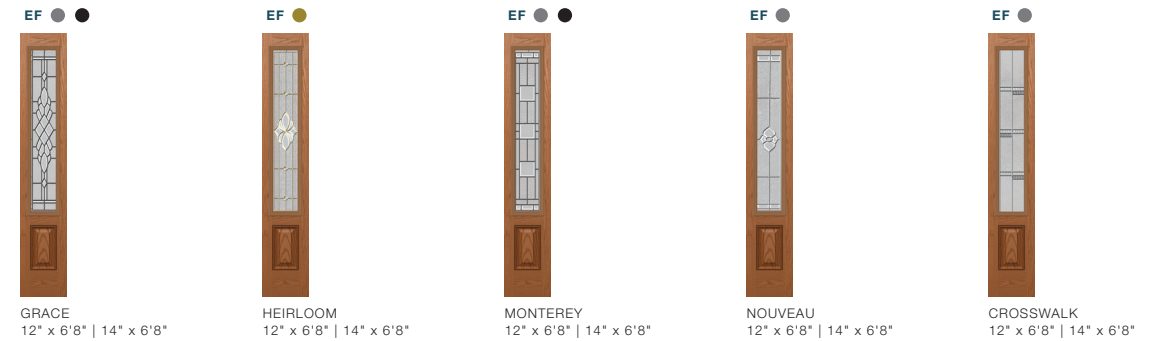
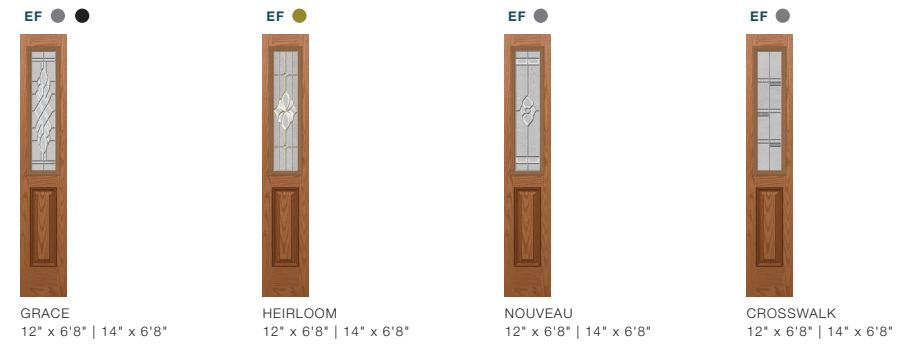

KEY

Glass = 22" x 36" for Half Lite Doors
 Glass = 22" x 48" for 3/4 Lite Doors
 Glass = 22" x 64" Full Lite Doors
 Glass = 8" x 36" for Half Lite Sidelites
 Glass = 8" x 48" for 3/4 Lite Sidelites
 Glass = 7" x 64" for Full Lite Sidelites

■ Black GBG
 ■ Silver Spacer

● Patina/Wrought Iron Caming
 ● Platinum/Satin Nickel Caming
 ● Brass Caming

EF Evolve Frame

Door size depicted is 3068

SIDELITE AND GLASS OPTIONS

DECORATIVE GLASS OAK SIDELITES CONT.

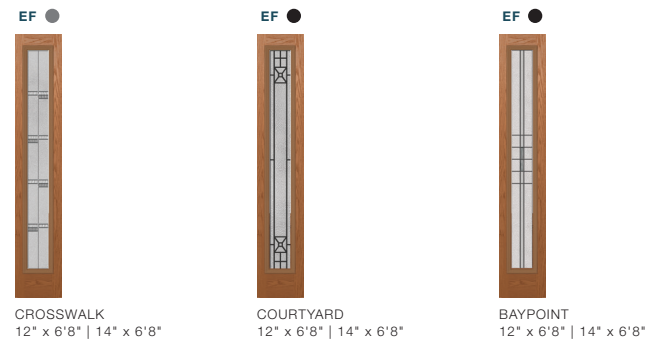
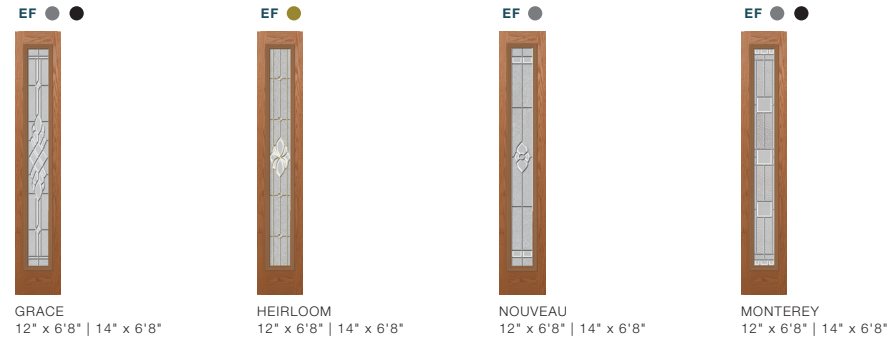

CLEAR LOW-E GLASS MAHOGANY SIDELITES



DECORATIVE GLASS MAHOGANY SIDELITES



SIDELITE AND GLASS OPTIONS

DECORATIVE GLASS MAHOGANY SIDELITES CONT.

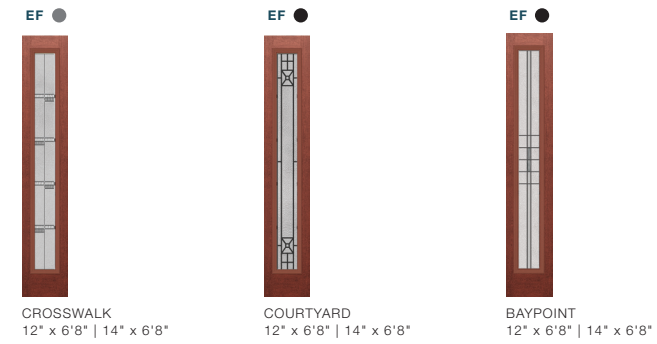

KEY

Glass = 8" x 36" for Half Lite Sidelites
Glass = 8" x 48" for 3/4 Lite Sidelites
Glass = 7" x 64" for Full Lite Sidelites

■ Black GBG
■ Silver Spacer

● Patina/Wrought Iron Caming
● Platinum/Satin Nickel Caming
● Brass Caming

EF Evolve Frame

Sidelite size depicted is 14"

CRAFTSMAN SERIES



DENTIL SHELF



BAYPOINT GLASS



- 1. CLEAR SEEDY GLASS
- 2. GRAY BUBBLE GLASS
- 3. HAMMERED GLASS
- 4. PATINA CAMING

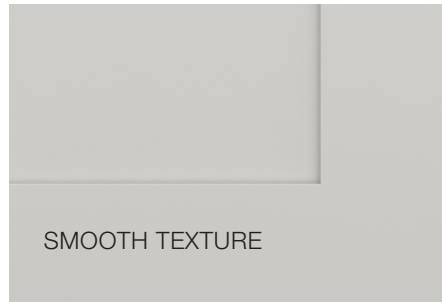

SMOOTH TEXTURE

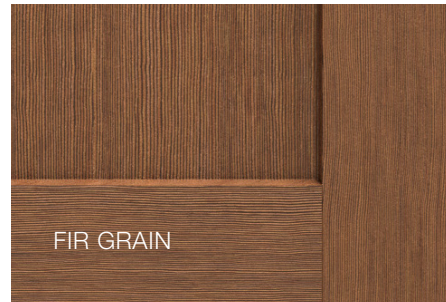

FIR GRAIN

HERITAGE STYLING MEETS CONTEMPORARY DESIGN

If you want an entrance that combines historical styling and modern appeal, the Craftsman Series is the best place to start. These doors combine notable design elements of 19th and 20th century architecture with modern engineering, featuring panels with shaker profiles.

In addition to direct glazed options, the Craftsman Series decorative glass lineup includes Baypoint, a contemporary nod to traditional doorglass that exudes lived-in luxury with its thoughtful minimalism. Boost the charm factor by adding a dentil shelf or simulated divided lite grids.

Available in perfect-for-painting Smooth texture or realistic Fir grain.

PANEL OPTIONS

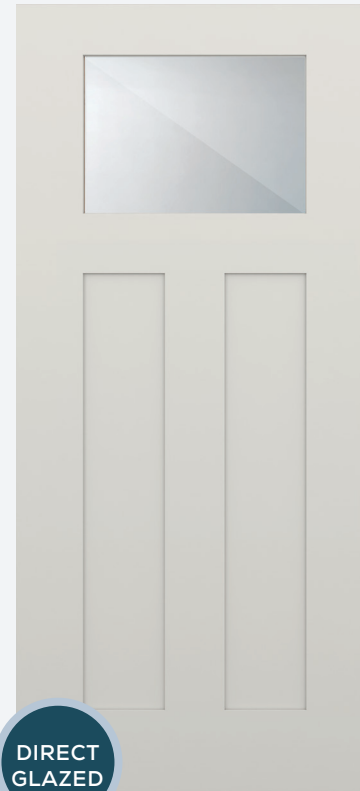

DIRECT GLAZED

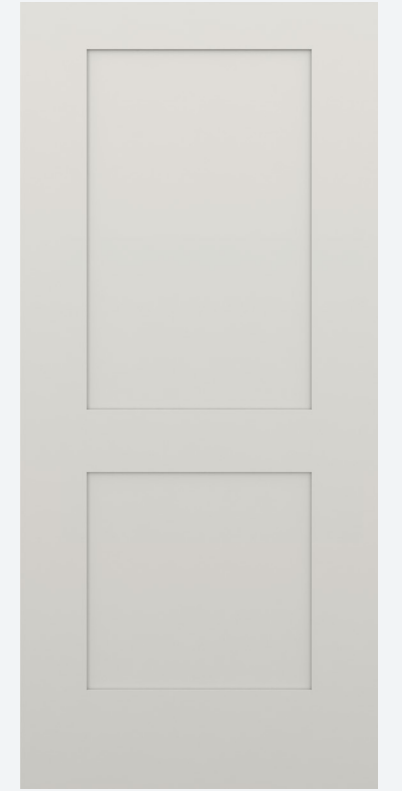
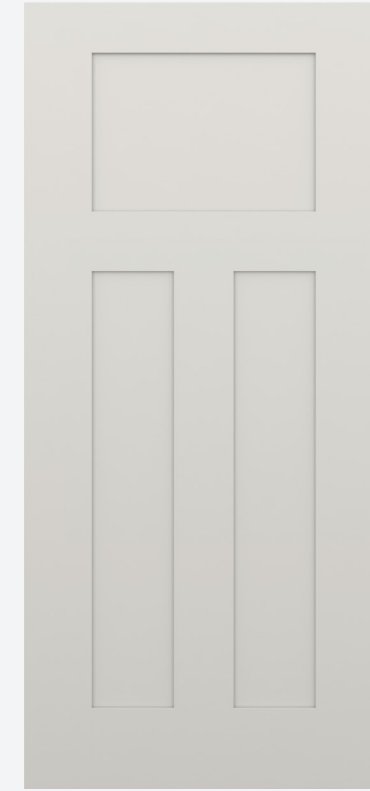

DIRECT GLAZED

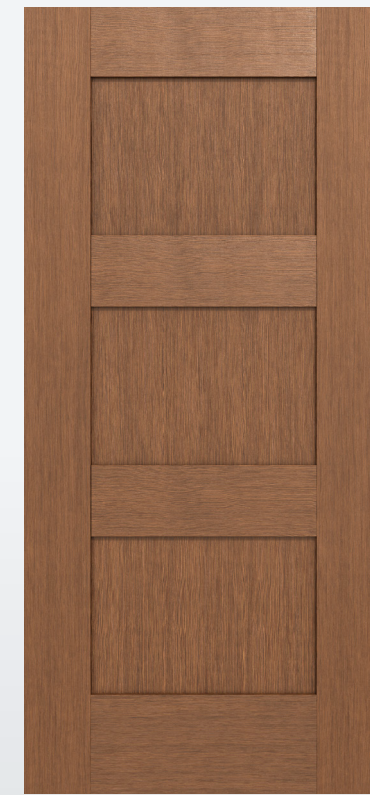

CRAFTSMAN SMOOTH

CLEAR LOW-E GLASS 2-PANEL DIRECT GLAZED



DG CLEAR LOW-E 2'8" x 6'8" | 3'0" x 6'8"
DG FLAT GBG 2'8" x 6'8" | 3'0" x 6'8"
DG FLAT GBG 2'8" x 6'8" | 3'0" x 6'8"
DG FLAT GBG 2'8" x 6'8" | 3'0" x 6'8"
DG FLAT GBG 2'8" x 6'8" | 3'0" x 6'8"



DG APPLIED SDL WITH GBG 2'8" x 6'8" | 3'0" x 6'8"
DG APPLIED SDL WITH GBG 2'8" x 6'8" | 3'0" x 6'8"
DG APPLIED SDL WITH GBG 2'8" x 6'8" | 3'0" x 6'8"
DG APPLIED SDL WITH GBG 2'8" x 6'8" | 3'0" x 6'8"

CLEAR LOW-E GLASS 2-PANEL DOOR



ZF CLEAR LOW-E 2'8" x 6'8" | 2'10" x 6'8" | 3'0" x 6'8"
ZF FLAT GBG 2'8" x 6'8" | 2'10" x 6'8" | 3'0" x 6'8"
ZF FLAT GBG 2'8" x 6'8" | 2'10" x 6'8" | 3'0" x 6'8"
ZF FLAT GBG 2'8" x 6'8" | 2'10" x 6'8" | 3'0" x 6'8"
ZF FLAT GBG 2'8" x 6'8" | 2'10" x 6'8" | 3'0" x 6'8"



ZF APPLIED SDL WITH GBG 2'8" x 6'8" | 2'10" x 6'8" | 3'0" x 6'8"
ZF APPLIED SDL WITH GBG 2'8" x 6'8" | 2'10" x 6'8" | 3'0" x 6'8"
ZF APPLIED SDL WITH GBG 2'8" x 6'8" | 2'10" x 6'8" | 3'0" x 6'8"
ZF APPLIED SDL WITH GBG 2'8" x 6'8" | 2'10" x 6'8" | 3'0" x 6'8"

CRAFTSMAN DOOR AND GLASS OPTIONS

PRIVACY LOW-E GLASS 2-PANEL DOOR



ZF BLANCA 2'8" x 6'8" | 2'10" x 6'8" | 3'0" x 6'8"
ZF BLANCA WITH APPLIED SDL 2'8" x 6'8" | 2'10" x 6'8" | 3'0" x 6'8"
ZF BLANCA WITH APPLIED SDL 2'8" x 6'8" | 2'10" x 6'8" | 3'0" x 6'8"
ZF BLANCA WITH APPLIED SDL 2'8" x 6'8" | 2'10" x 6'8" | 3'0" x 6'8"
ZF BLANCA WITH APPLIED SDL 2'8" x 6'8" | 2'10" x 6'8" | 3'0" x 6'8"



ZF CHINCHILLA 2'8" x 6'8" | 2'10" x 6'8" | 3'0" x 6'8"
ZF CHINCHILLA WITH APPLIED SDL 2'8" x 6'8" | 2'10" x 6'8" | 3'0" x 6'8"
ZF CHINCHILLA WITH APPLIED SDL 2'8" x 6'8" | 2'10" x 6'8" | 3'0" x 6'8"
ZF CHINCHILLA WITH APPLIED SDL 2'8" x 6'8" | 2'10" x 6'8" | 3'0" x 6'8"
ZF CHINCHILLA WITH APPLIED SDL 2'8" x 6'8" | 2'10" x 6'8" | 3'0" x 6'8"

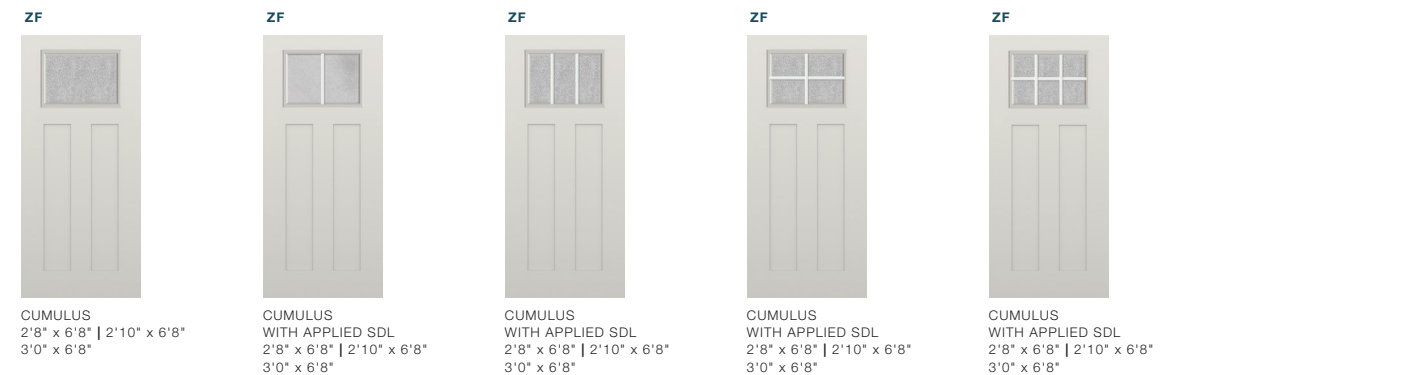

ZF CUMULUS 2'8" x 6'8" | 2'10" x 6'8" | 3'0" x 6'8"
ZF CUMULUS WITH APPLIED SDL 2'8" x 6'8" | 2'10" x 6'8" | 3'0" x 6'8"
ZF CUMULUS WITH APPLIED SDL 2'8" x 6'8" | 2'10" x 6'8" | 3'0" x 6'8"
ZF CUMULUS WITH APPLIED SDL 2'8" x 6'8" | 2'10" x 6'8" | 3'0" x 6'8"
ZF CUMULUS WITH APPLIED SDL 2'8" x 6'8" | 2'10" x 6'8" | 3'0" x 6'8"



ZF MICRO-GRANITE 2'8" x 6'8" | 2'10" x 6'8" | 3'0" x 6'8"
ZF MICRO-GRANITE WITH APPLIED SDL 2'8" x 6'8" | 2'10" x 6'8" | 3'0" x 6'8"
ZF MICRO-GRANITE WITH APPLIED SDL 2'8" x 6'8" | 2'10" x 6'8" | 3'0" x 6'8"
ZF MICRO-GRANITE WITH APPLIED SDL 2'8" x 6'8" | 2'10" x 6'8" | 3'0" x 6'8"
ZF MICRO-GRANITE WITH APPLIED SDL 2'8" x 6'8" | 2'10" x 6'8" | 3'0" x 6'8"

KEY

Glass = 22" x 15" for Craftsman Lite Doors

■ Black GBG

ZF Zeel Frame

DG Direct Glazed

Door size depicted is 3068

CRAFTSMAN SMOOTH

PRIVACY LOW-E GLASS 2-PANEL DOOR CONT.



DECORATIVE GLASS 2-PANEL DOOR



CLEAR LOW-E GLASS 1-PANEL SHAKER DOOR

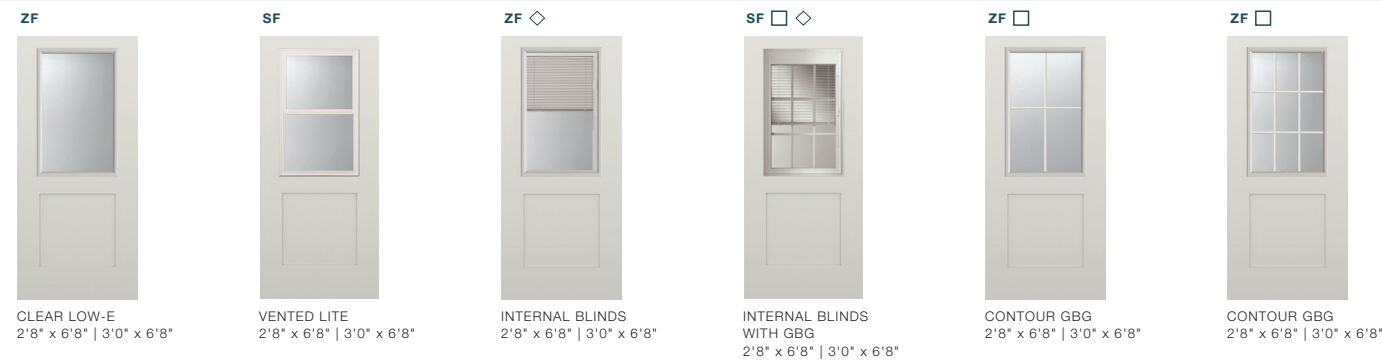

SHAKER DOOR AND GLASS OPTIONS

PRIVACY LOW-E GLASS 1-PANEL SHAKER DOOR

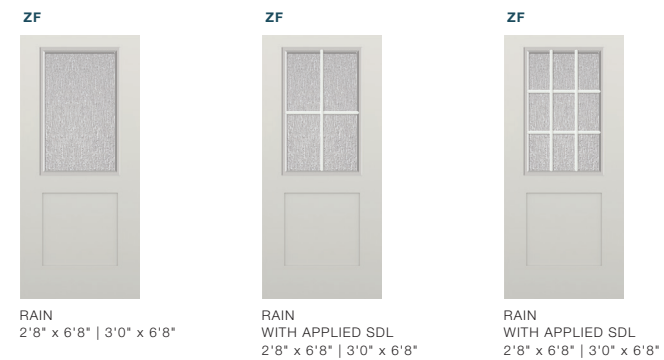

DECORATIVE GLASS 1-PANEL SHAKER DOOR

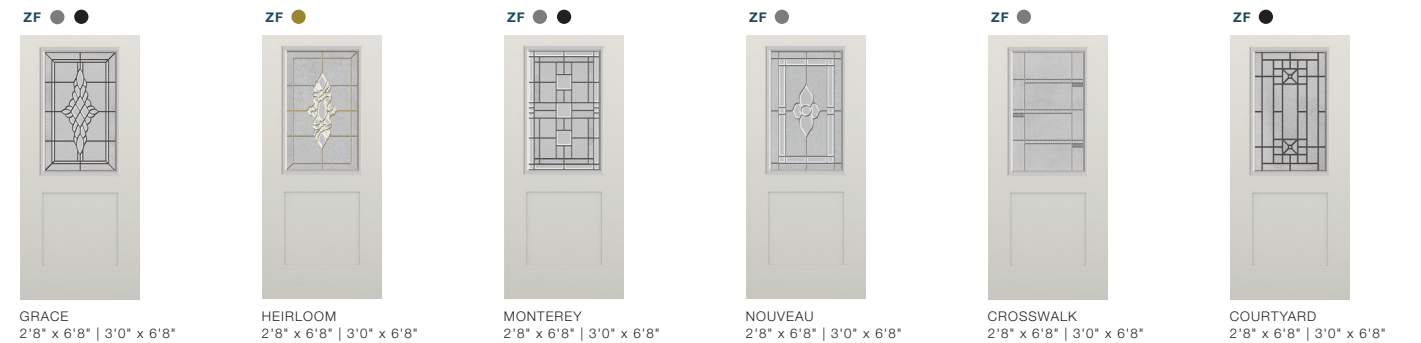

KEY

Glass = 22" x 36" for Half Lite Doors
Glass = 22" x 15" for Craftsman Lite Doors

- Black GBG
- White GBG
- Silver Spacer
- ◇ White Blinds

- Patina/Wrought Iron Caming
- Platinum/Satin Nickel Caming
- Brass Caming

- ZF Zeel Frame
- EF Evolve Frame
- SF Standard Frame

Door size depicted is 3068

CRAFTSMAN FIR AND SMOOTH

DIRECT GLAZED

CLEAR LOW-E GLASS 2-PANEL DIRECT GLAZED DOOR

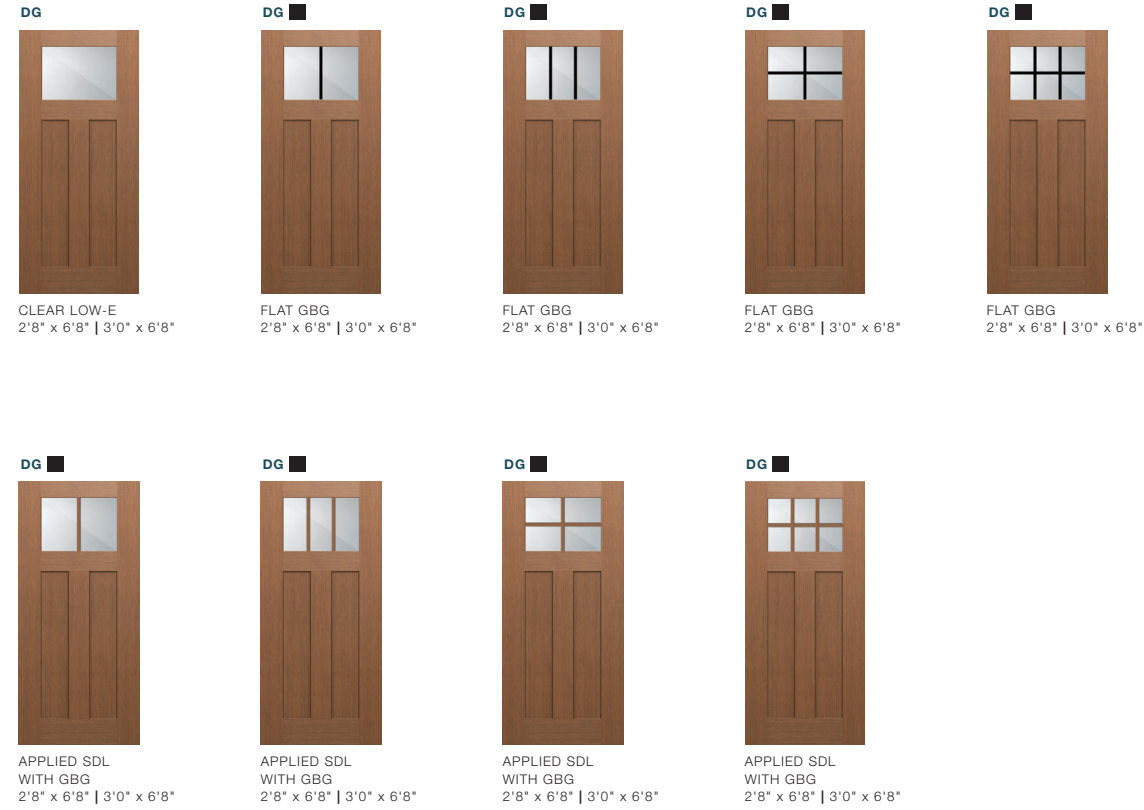

CLEAR LOW-E GLASS DIRECT GLAZED SIDELITES

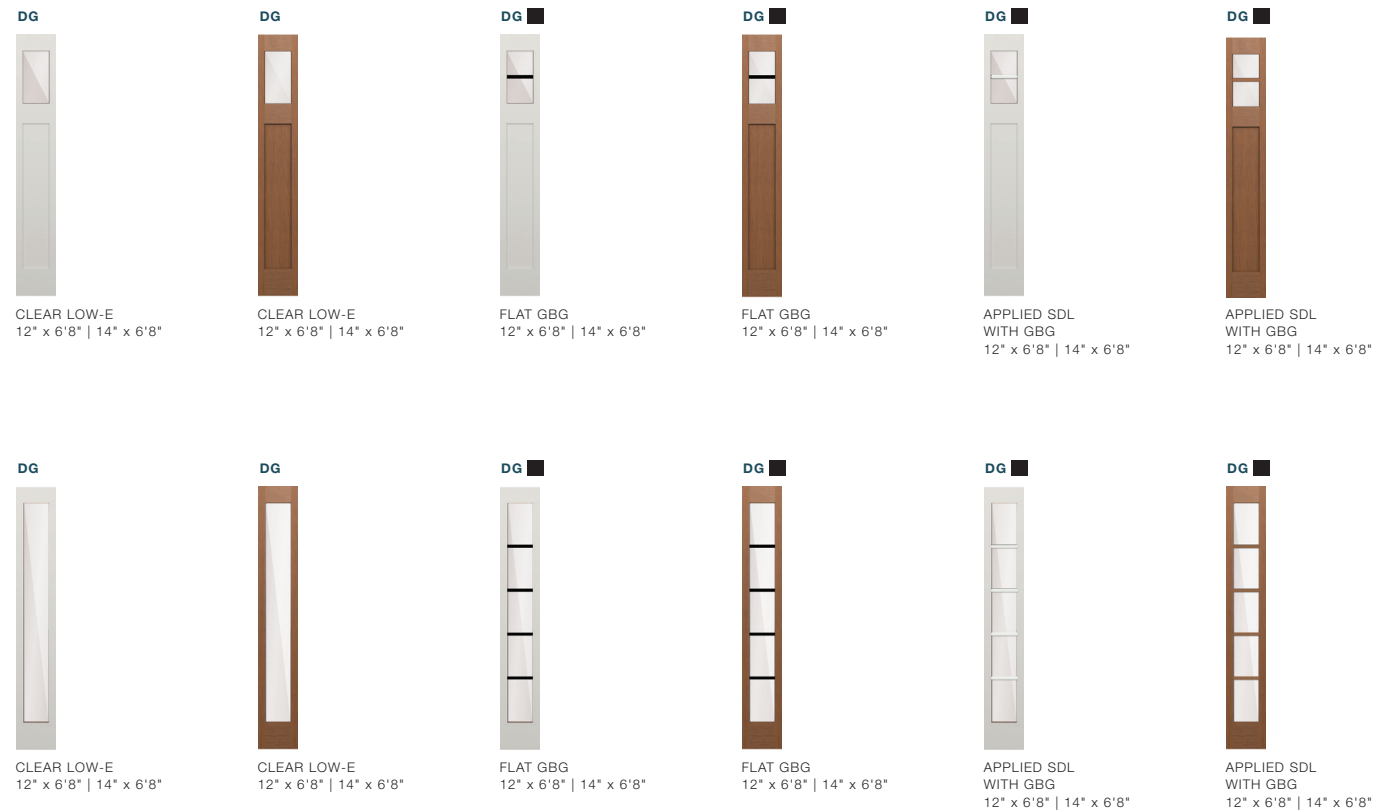

KEY

Glass = 22" x 15" for Craftsman Lite Doors
 Glass = 8" x 16" for Craftsman Sidelites

■ Black GBG

DG Direct Glazed

Door size depicted is 3068
 Sidelite size depicted is 14"

MODERN SERIES



A SEAMLESS, HIGH-END STATEMENT

For the home that embraces a contemporary appearance, there's no better match than the Modern Series. Refresh your entryway with the minimalist clean lines, unique lite configurations, and large expanses of glass that characterize these door styles.

Go bold with the ONYX finish, a pre-pigmented, black fiberglass skin that accentuates the polished look of your entrance without the frequent need to touch up paint. ONYX is available in 3/4 or full lite glass directly glazed into a modern door with Shaker sticking. The Brushed Smooth texture adds subtle interest.

PANEL OPTIONS



1, 3, 5 LITE DOOR AND GLASS OPTIONS

CLEAR LOW-E GLASS

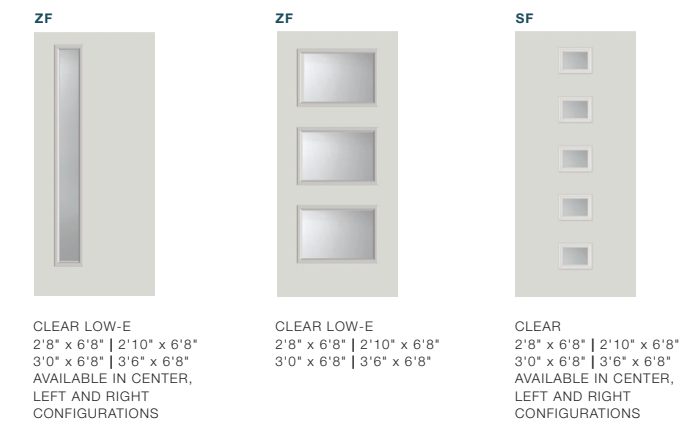

MODERN SMOOTH

PRIVACY LOW-E GLASS 3-LITE DOOR

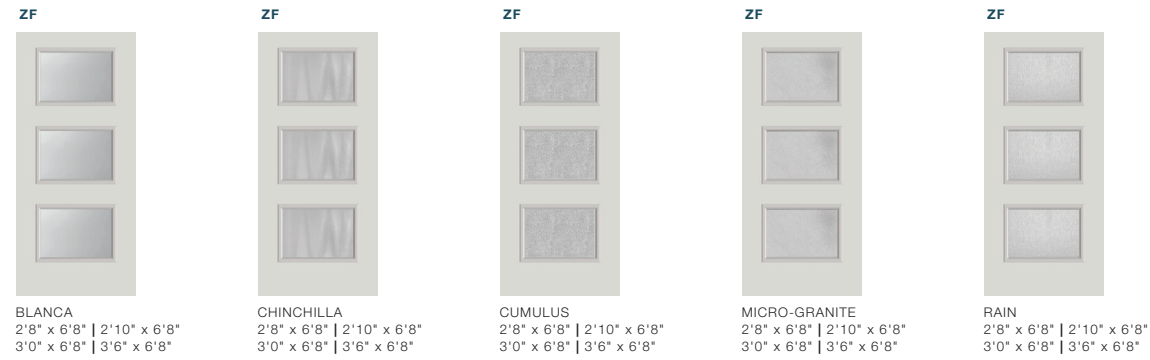

DECORATIVE GLASS 3-LITE DOOR

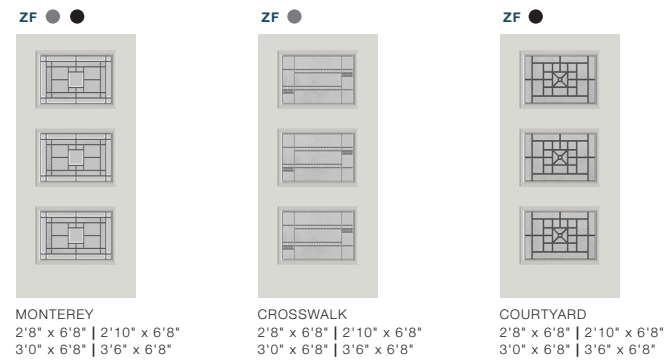

PRIVACY LOW-E GLASS 1-LITE DOOR

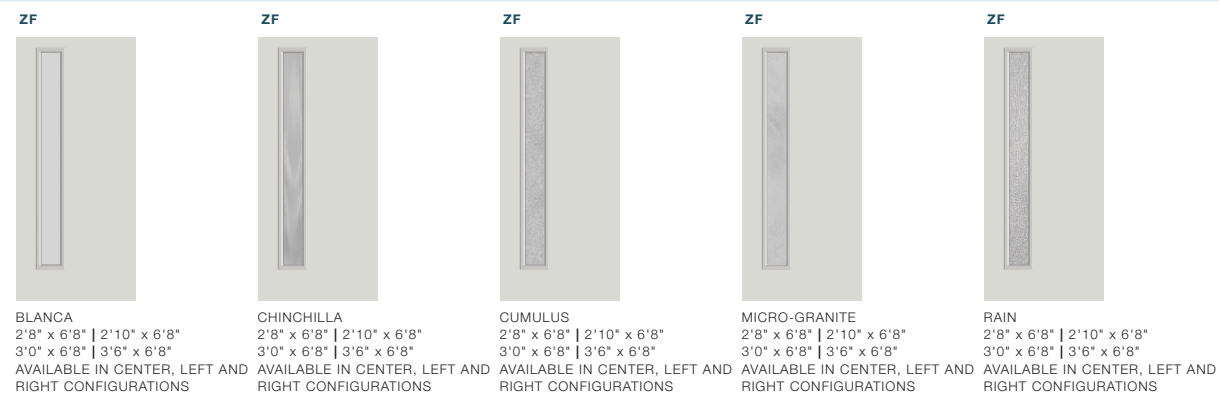

DECORATIVE GLASS 1-LITE DOOR

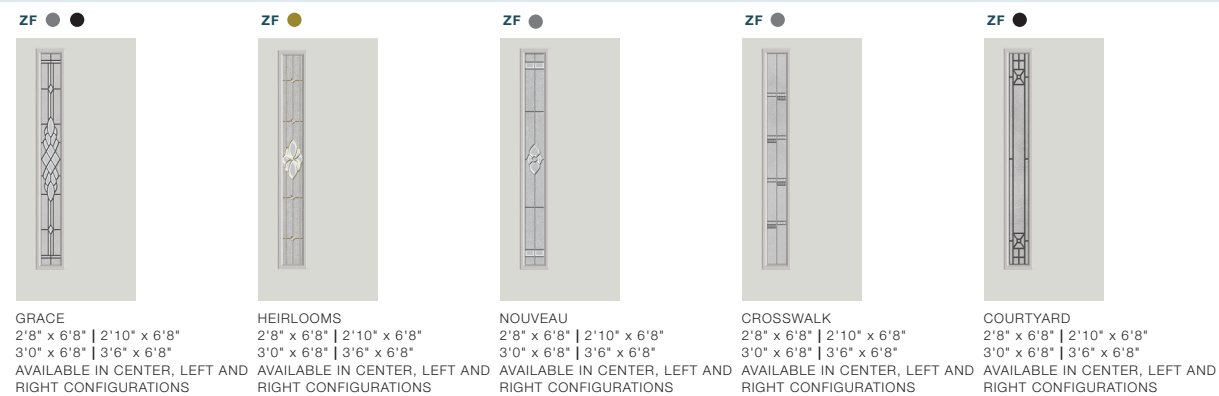

DIRECT GLAZED MODERN SERIES

Enhance the aesthetics and natural lighting of your home with direct glazed glass in 3/4 and full lite configurations that create a seamless and elegant design.

Take a step further with our durable ONYX pigmented fiberglass skin that gives you the contemporary look of a black door, but without the need for frequent maintenance or painting.

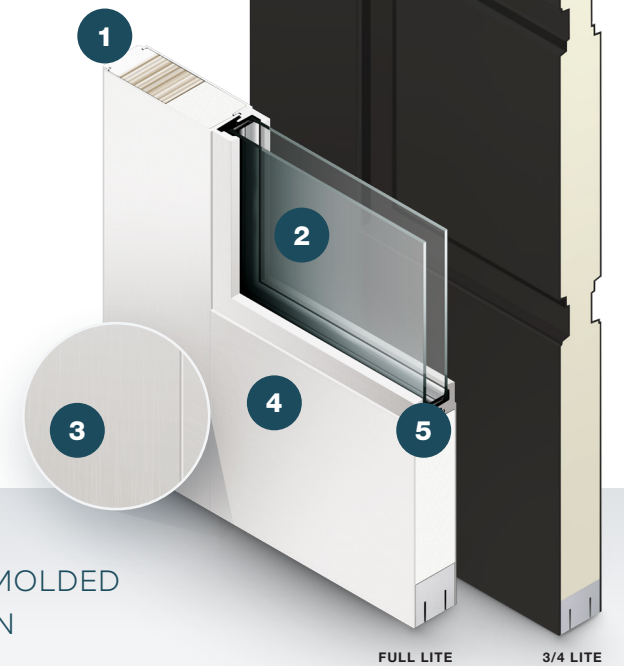

- 1** COMPOSITE STILE CAP
- 2** INSULATED 1" GLASS
- 3** BRUSHED SMOOTH TEXTURE
- 4** COMPRESSION MOLDED FIBERGLASS SKIN
- 5** INTEGRALLY MOLDED GLASS STOP

KEY

Glass = 7" x 64" for 1-Lite Doors
Glass = 22" x 15" for 2-Lite Doors

● Patina/Wrought Iron Caming
● Platinum/Satin Nickel Caming
● Brass Caming

ZF Zeel Frame

Door size depicted is 3068





MODERN BRUSHED SMOOTH



CLEAR LOW-E GLASS DIRECT GLAZED DOORS

 CLEAR LOW-E 2'6" x 6'8" 2'8" x 6'8" 3'0" x 6'8"	 CLEAR LOW-E 2'8" x 6'8" 3'0" x 6'8"	 FLAT GBG 2'6" x 6'8" 2'8" x 6'8" 3'0" x 6'8"	 FLAT GBG 2'8" x 6'8" 3'0" x 6'8"	 FLAT GBG 2'6" x 6'8" 2'8" x 6'8" 3'0" x 6'8"	 FLAT GBG 2'8" x 6'8" 3'0" x 6'8"
---	---	---	--	---	--

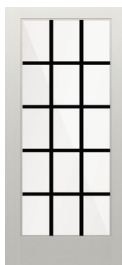
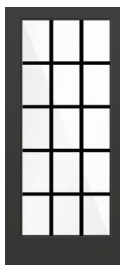
 APPLIED SDL WITH GBG 2'6" x 6'8" 2'8" x 6'8" 3'0" x 6'8"	 APPLIED SDL WITH GBG 2'8" x 6'8" 3'0" x 6'8"	 APPLIED SDL WITH GBG 2'6" x 6'8" 2'8" x 6'8" 3'0" x 6'8"	 APPLIED SDL WITH GBG 2'8" x 6'8" 3'0" x 6'8"	 INTERNAL BLINDS 2'8" x 6'8" 3'0" x 6'8"
---	---	--	---	---

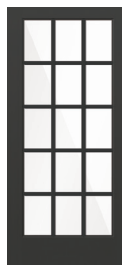
 CLEAR LOW-E 2'6" x 6'8" 2'8" x 6'8" 3'0" x 6'8"	 CLEAR LOW-E 2'8" x 6'8" 3'0" x 6'8"	 FLAT GBG 2'6" x 6'8" 2'8" x 6'8" 3'0" x 6'8"	 FLAT GBG 2'8" x 6'8" 3'0" x 6'8"	 APPLIED SDL WITH GBG 2'6" x 6'8" 2'8" x 6'8" 3'0" x 6'8"	 APPLIED SDL WITH GBG 2'8" x 6'8" 3'0" x 6'8"
---	---	---	--	--	---









PRIVACY LOW-E GLASS DIRECT GLAZED DOORS

 RAIN 2'6" x 6'8" 2'8" x 6'8" 3'0" x 6'8"	 RAIN 2'8" x 6'8" 3'0" x 6'8"	 RAIN WITH APPLIED SDL 2'6" x 6'8" 2'8" x 6'8" 3'0" x 6'8"	 RAIN WITH APPLIED SDL 2'8" x 6'8" 3'0" x 6'8"	 RAIN WITH APPLIED SDL 2'6" x 6'8" 2'8" x 6'8" 3'0" x 6'8"	 RAIN WITH APPLIED SDL 2'8" x 6'8" 3'0" x 6'8"
--	--	---	--	---	--

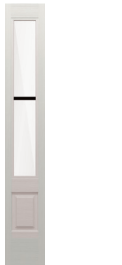

DIRECT GLAZED DOOR / SIDELITE AND GLASS OPTIONS







CLEAR LOW-E GLASS 3/4 LITE DIRECT GLAZED SIDELITES

 CLEAR LOW-E 12" x 6'8" 14" x 6'8"	 CLEAR LOW-E 12" x 6'8" 14" x 6'8"	 FLAT GBG 12" x 6'8" 14" x 6'8"	 FLAT GBG 12" x 6'8" 14" x 6'8"	 FLAT GBG 12" x 6'8" 14" x 6'8"	 FLAT GBG 12" x 6'8" 14" x 6'8"
 APPLIED SDL WITH GBG 12" x 6'8" 14" x 6'8"	 APPLIED SDL WITH GBG 12" x 6'8" 14" x 6'8"	 APPLIED SDL WITH GBG 12" x 6'8" 14" x 6'8"	 APPLIED SDL WITH GBG 12" x 6'8" 14" x 6'8"		

PRIVACY LOW-E GLASS 3/4 LITE DIRECT GLAZED SIDELITES

 RAIN 12" x 6'8" 14" x 6'8"	 RAIN 12" x 6'8" 14" x 6'8"
--	--

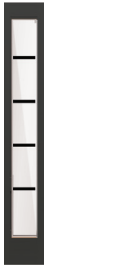
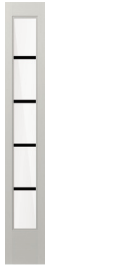
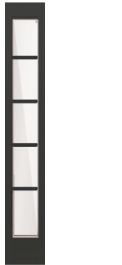
CLEAR LOW-E GLASS FULL LITE DIRECT GLAZED SIDELITES

 CLEAR LOW-E 12" x 6'8" 14" x 6'8"	 CLEAR LOW-E 12" x 6'8" 14" x 6'8"	 FLAT GBG 12" x 6'8" 14" x 6'8"	 FLAT GBG 12" x 6'8" 14" x 6'8"	 APPLIED SDL WITH GBG 12" x 6'8" 14" x 6'8"	 APPLIED SDL WITH GBG 12" x 6'8" 14" x 6'8"
---	---	--	--	---	---

KEY
 Direct glazed visible measurements vary by style and size.

- Black GBG
- ◇ White Blinds
- ONYX Finish

DG Direct Glazed

Door size depicted is 3068
 Sidelite size depicted is 14"

SPECIALTY SERIES



Plastpro's Fire Rated doors are made with fire-resistant composite creating an extremely durable entryway. Doors are tested and comply with safety and performance standards to withstand fire for a minimum of 20 minutes.

1 EXTENDED LOCKBLOCK

Full-length LVL increases the rigidity of the door.

2 FIRE RETARDANT COMPOSITE

HFO Polyurethane fire rated foam system is specially formulated to withstand fire.

3 FULL LENGTH COMPOSITE STILES

Full-length composite stiles protect the door from external exposure.

4 PLASTPRO® EXCLUSIVE SMC SKIN

Skin material is specially formulated and comes two panel configurations.

5 COMPOSITE BOTTOM RAIL

High strength rails prevent moisture from seeping into the door.

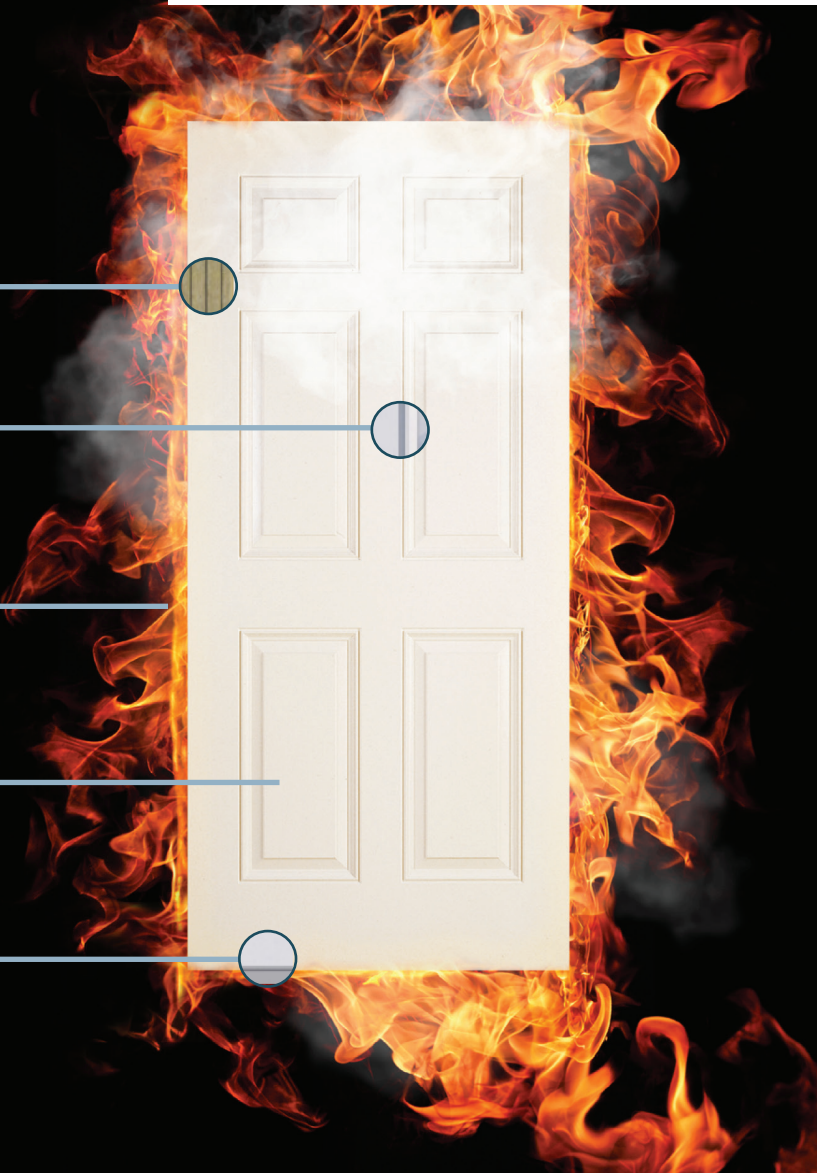

20-MIN FIRE DOOR OPTIONS

FIBERGLASS SOLID DOORS



2'8" x 6'8" | 3'0" x 6'8"



2'8" x 6'8" | 3'0" x 6'8"



20-Minute and 90-Minute 6-Panel steel fire doors are also available. Please see ordering system or ask your Harvey Representative for more details.

HARVEY ENTRY DOOR SYSTEM – LIMITED LIFETIME WARRANTY

Harvey Entry Door Systems are manufactured from raw materials of the highest quality using the most up-to-date and modern production techniques and are guaranteed to be free of defects in material and workmanship. They are warranted for residential installations as follows.

LIFETIME WARRANTY – COMPONENTS

Harvey Entry Door System slabs, frames, hardware, and components such as hinges, weatherstrip, door bottom, and astragals are warranted against defects in material and workmanship for as long as the original purchaser owns and resides in the home in which they are installed.

LIFETIME WARRANTY – INSULATED GLASS

Insulating glass, including blinds between glass, inserts, decorative, and applied grids is warranted against material obstruction of transparency resulting from film formation or dust collection on the interior surfaces for as long as the original purchaser owns and resides in the home in which they are installed.

TRANSFERABILITY

If the original purchaser sells the property in which the doors are installed, the coverage provided by this warranty will be limited to only the next subsequent owner and will be twenty (20) years from the date of manufacture.

EXCLUSIONS AND LIMITATIONS

The above warranty periods commence on the date of shipment from the manufacturing facility. Steel doors are covered for a period of ten (10) years.

This warranty excludes defects or failures caused by normal wear and tear; broken glass; damages resulting from improper installation; damage caused by corrosive fumes, stains, contact with chemically abrasive substances; damage caused by airborne pollutants such as salt or acid rain; negligence or unreasonable use (including failure to provide reasonable and necessary maintenance); damage caused by shipping or any other means of transportation or handling that occur after the product leaves the manufacturing facility; stress resulting from localized application of heat that causes excessive temperature differential over the door or glass surface or the edges of the unit; damage caused by high winds, floods, and/or conditions that exceed product design ratings; damage resulting

from fire, lightning, windstorms, earthquakes, windborne objects, strain applied to the unit by movement of the building or building components, or inadequate provision for expansion or contraction of framing members; condensation, which is a natural result of humidity within the home and the difference between the internal and exterior temperatures; installation in ships, vehicles, or outside the continental United States; seal failure if the seal has been subject to immersion in water; acts of God or other causes beyond the control of the manufacturer.

This warranty covers only manufacturing defects, is limited to repairing or replacing defective parts or components, and providing return transportation to the manufacturer's nearest place of business, and does not include labor or other costs incurred in the removal, replacement, installation, or reinstallation of the product or any part or component of the product. Harvey Building Products reserves the right to discontinue or modify any of its products without notice and will not be liable under this limited warranty as a result of such discontinuance or modification and will have the right to substitute products which, in its sole discretion, are of equal value and quality.

This warranty is intended to cover individual homeowners and does not apply to products purchased by or installed in commercial applications such as property owned by corporations, governmental agencies, partnerships, trusts, religious organizations, schools, or cooperative housing arrangements, or installed on apartment buildings or any other type of buildings or premises not used by individual homeowners as their residence. For such purchasers or entities to which this coverage does not apply, the warranty period will be ten (10) years following the date of original installation.

The statements contained herein set forth the only express warranties of the above products. Any implied warranties imposed by law, such as implied warranties of merchantability or fitness for a particular purpose, are limited in time to the duration of the above express warranties. The manufacturer shall not be liable to the buyer for incidental or consequential damages for breach of any written or implied warranty.

Some states do not allow limitations on how long an implied warranty lasts, and some states do not allow the exclusion or limitation of incidental or consequential damages, so the above limitations or exclusions may not apply to you. This warranty gives you specific legal rights, and you may have other rights which vary from state to state.

CLAIMS PROCEDURES

The product should first be inspected by the company that sold and installed the product to the homeowner within a reasonable time after discovery of a problem to determine if the problem is installation or product related.

To make a claim under this warranty for a product defect, either the contracting company or the homeowner should notify Harvey Building Products by calling our Field Service Department at 1-800-822-0437, visiting our website at harveywindows.com, or sending an email to fieldservice@harveybp.com. The claim must identify the company that the product was purchased from, the door type, installation date, serial number and the specific defect.

CONTRACTING COMPANY

Name _____
 Address _____
 Installation Date _____
 Order # _____
 Phone _____

HOMEOWNER / PURCHASER

Name _____
 Address _____

DOOR OPENING DIMENSIONS

6'8 Doors Call Size Width	Actual Frame Width	Stud-to-Stud RO Min. Width	Standard Sill Unit Height				ADA Sill Unit Height				
			Inswing Actual Frame Height	Inswing Frame RO Height	Outswing Actual Frame Height	Outswing Frame RO	Inswing Actual Frame Height	Inswing Frame RO	Outswing Actual Frame Height	Outswing Frame RO	
Single	2'4"	29-7/16"	82"	82-1/2"	80-5/8"	81-3/8"	80-15/16"	81-7/16"	TBD	TBD	
	2'6"	31-7/16"									32-3/16"
	2'8"	33-7/16"									34-3/16"
	2'10"	35-7/16"									36-3/16"
	3'0"	37-7/16"									38-3/16"
	3'6"	43-7/16"									44-3/16"
Double	4'8"	57-7/8"	82"	82-1/2"	80-5/8"	81-3/8"	80-15/16"	81-7/16"	TBD	TBD	
	5'0"	61-7/8"									62-5/8"
	5'4"	65-7/8"									66-5/8"
	5'8"	69-7/8"									70-5/8"
	6'0"	73-7/8"									74-5/8"
	7'0"	85-7/8"									86-5/8"
Patio	5'0"	62-5/16"	82"	82-1/2"	-	-	-	-	-	-	
	5'8"	70-5/16"									71-1/16"
	6'0"	74-5/16"									75-1/16"

For 6'6" doors, minus 2" from 6'8" frame height and and RO height.

6'8 Doors Fixed Sidelites Call Size Width	Actual Frame Width			Stud-to-Stud RO Min. Width		
	10"	12"	14"	10"	12"	14"
2'4" Single Door w/1 sidelite	40-15/16"	42-15/16"	44-5/16"	41-11/16"	43-11/16"	45-11/16"
2'6" Single Door w/1 sidelite	42-15/16"	44-15/16"	46-5/16"	43-11/16"	45-11/16"	47-11/16"
2'8" Single Door w/1 sidelite	44-15/16"	46-15/16"	48-5/16"	45-11/16"	47-11/16"	49-11/16"
2'10" Single Door w/1 sidelite	46-15/16"	48-15/16"	50-5/16"	47-11/16"	49-11/16"	51-11/16"
3'0" Single Door w/1 sidelite and continuous sill	48-7/16"	50-7/16"	52-7/16"	49-3/16"	51-3/16"	53-3/16"
3'0" Single Door w/1 sidelite	48-15/16"	50-15/16"	52-15/16"	49-11/16"	51-11/16"	53-11/16"
3'6" Single Door w/1 sidelite	54-15/16"	56-15/16"	58-15/16"	55-11/16"	57-11/16"	59-11/16"
2'4" Single Door w/2 sidelites	52-7/16"	56-7/16"	60-7/16"	53-3/16"	57-3/16"	61-3/16"
2'6" Single Door w/2 sidelites	54-7/16"	58-7/16"	62-7/16"	55-3/16"	59-3/16"	63-3/16"
2'8" Single Door w/2 sidelites	56-7/16"	60-7/16"	64-7/16"	57-3/16"	61-3/16"	65-3/16"
2'10" Single Door w/2 sidelites	58-7/16"	62-7/16"	66-7/16"	59-3/16"	63-3/16"	67-3/16"
3'0" Single Door w/2 sidelites and continuous sill	59-1/2"	63-1/2"	67-1/2"	60-1/4"	64-1/4"	68-1/4"
3'0" Single Door w/2 sidelites	60-7/16"	64-7/16"	68-7/16"	61-3/16"	65-3/16"	69-3/16"
3'6" Single Door w/2 sidelites	66-7/16"	70-7/16"	74-7/16"	67-3/16"	71-3/16"	75-3/16"
4'8" Double Door w/1 sidelite	69-3/8"	71-3/8"	73-3/8"	70-1/8"	72-1/8"	74-1/8"
5'0" Double Door w/1 sidelite	73-3/8"	75-3/8"	77-3/8"	74-1/8"	76-1/8"	78-1/8"
5'4" Double Door w/1 sidelite	77-3/8"	79-3/8"	81-3/8"	78-1/8"	80-1/8"	82-1/8"
5'8" Double Door w/1 sidelite	81-3/8"	83-3/8"	85-3/8"	82-1/8"	84-1/8"	86-1/8"
6'0" Double Door w/1 sidelite	85-3/8"	87-3/8"	89-3/8"	86-1/8"	88-1/8"	90-1/8"
7'0" Double Door w/1 sidelite	97-3/8"	99-3/8"	101-3/8"	98-1/8"	100-1/8"	102-1/8"
4'8" Double Door w/2 sidelites	80-7/8"	84-7/8"	88-7/8"	81-5/8"	85-5/8"	89-5/8"
5'0" Double Door w/2 sidelites	84-7/8"	88-7/8"	92-7/8"	85-5/8"	89-5/8"	93-5/8"
5'4" Double Door w/2 sidelites	88-7/8"	92-7/8"	96-7/8"	89-5/8"	93-5/8"	97-5/8"
5'8" Double Door w/2 sidelites	92-7/8"	96-7/8"	100-7/8"	93-5/8"	97-5/8"	101-5/8"
6'0" Double Door w/2 sidelites	96-7/8"	100-7/8"	104-7/8"	97-5/8"	101-5/8"	105-5/8"
7'0" Double Door w/ 2 sidelites	108-7/8"	112-7/8"	116-7/8"	109-5/8"	113-5/8"	117-5/8"

For frame and RO heights, see chart on page 58 based on your sill selection.

HANDING AND SWING SHOWN FROM OUTSIDE VIEW

INSWING



SINGLE - LEFT HINGE

INSWING

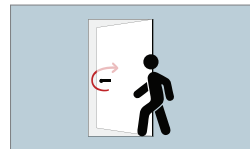

SINGLE - RIGHT HINGE

OUTSWING



SINGLE - LEFT HINGE

OUTSWING



SINGLE - RIGHT HINGE

INSWING



DOUBLE - ACTIVE LEFT

INSWING



DOUBLE - ACTIVE RIGHT

OUTSWING

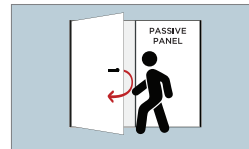

DOUBLE - ACTIVE LEFT

OUTSWING

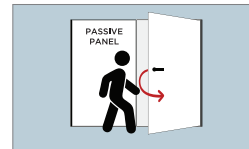

DOUBLE - ACTIVE RIGHT

INSWING ONLY

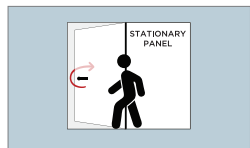

PATIO
ASR - LEFT HINGE

INSWING ONLY

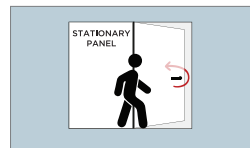

PATIO
SAL - RIGHT HINGE

6'8 Doors with Transom Call Size Width	Actual Frame Width	Stud-to-Stud RO Min. Width	Frame Height		Stud-to-Stud RO Height	
			12"	14"	12"	14"
3'0" Single Door w/ Transom	37-7/16"	38-3/16"	94"	96"	94-1/2"	96-1/2"
3'0" Single Door w/2 -12" sidelites (boxed sill)	64-7/16"	65-3/16"	94"	96"	94-1/2"	96-1/2"
3'0" Single Door w/2 -12" sidelites (continuous sill)	63-1/2"	64-1/4"	94"	96"	94-1/2"	96-1/2"
6'0" Double Door	73-7/8"	74-5/8"	94"	96"	94-1/2"	96-1/2"

Transoms available knock-down in widths above at heights of 12" or 14".



Visit us at [harveywindows.com](https://www.harveywindows.com)

© 2024 Harvey Windows + Doors. Due to printing limitations, finishes and colors shown in this brochure are for representation only.