

Your StarLink Charger User Manual

For charging mRIC R & RIC RT hearing aids



Chargers included:

[StarLink Chargers](#)

[StarLink Premium Mini Chargers](#)

Congrats!

The power
to hear better
is yours.

**You've got a StarLink Charger.
Smart choice.**

Now you can get the most out of every day with reliable charging to power your hearing aids.

After all – when you hear better, you live better.

Go ahead, have a read. And get ready to **experience the power of better hearing.**

What's included

Chargers covered in this user manual (select yours):

- StarLink Charger
- StarLink Premium Mini Charger*

**StarLink Premium Mini Chargers contain an on-board, rechargeable lithium-ion battery that is not removable.*

Table of contents

1. Get to know your charger

Meet your charger 8

Use your charger 9

Care for your charger 13

2. Troubleshooting guide 16

3. Additional guidance

Intended use 22

FCC information 24

Regulatory information 25

Get to know your charger

- Meet your charger
- Use your charger
- Care for your charger

Meet your charger

Overview

1. Cleaning tool (included accessory)
2. Earbud/earmold space
3. Charging slots
4. Indicator lights
5. USB-C port
6. Power cord & adapter

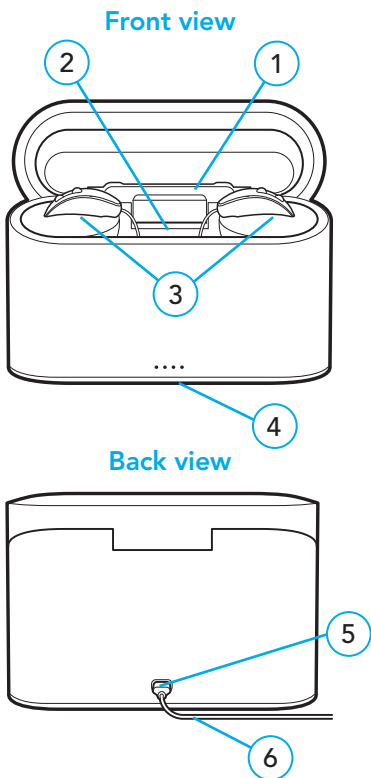

Use your charger

It is recommended that you fully charge your hearing aids before using them.

To charge your hearing aids

1. Plug your charger into an external power source, like a wall outlet.

The indicator lights turn white when your charger is connected. You're now ready to charge.

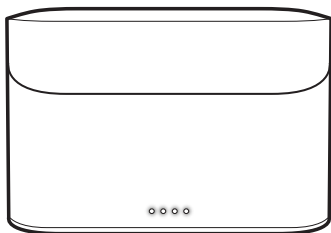

Reminder – StarLink Chargers require an external power source to charge hearing aids (e.g., a wall outlet). StarLink Premium Mini Chargers let you charge hearing aids cordless or plugged into an external power source (e.g., a wall outlet).

Use your charger

2. Place your hearing aids in the charging slot:
 - The right indicator light turns ON for 10 seconds when you insert the right hearing aid.
 - The left indicator light turns ON for 10 seconds when you insert the left hearing aid.

NOTE: *If the indicator lights do not turn ON or follow the indicator status behavior in step 3, your charger may need to be plugged in. See the Troubleshooting guide on p. 16.*



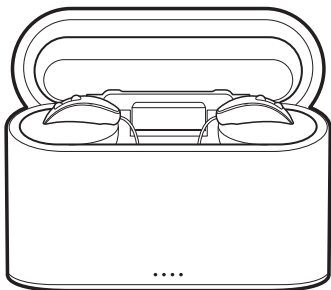

- Rest the earbuds or earmolds in the open earbud/earmold space. Your hearing aids will turn OFF and start charging.

Charger can be open or closed while charging.



Use your charger

3. Check the charging status of your hearing aids using the indicator lights on the outside of the charger:

Number of solid white lights	Hearing aid battery level	Hearing aid charging time
	Up to 25% charged	7 mins*
	Up to 50% charged	1.5 hrs
	Up to 75% charged	2.5 hrs
	100% charged	3.5 hrs

Your hearing aids will fully charge in 3.5 hours.

4. Take your hearing aids from the charger. They will turn ON – ready to wear.

*Before using your hearing aids for the first time, please see **Your Rechargeable Hearing Aid User Manual**.*





*Turbo Charging

Your charger comes with on-board turbo charging. Turbo charging automatically occurs when your battery is low. The hearing aid will rapidly charge, giving you 3 hours of use time in only 7 minutes of charging.

Use your charger

To charge your StarLink Premium Mini Charger

1. Plug your charger into an external power source, like a wall outlet.
2. Check the indicator lights to confirm the charging status of your charger.

Number of solid white lights	Charger battery level	Charger charging time
	Up to 25% charged	30 mins
	Up to 50% charged	1 hr
	Up to 75% charged	1.5 hrs
	100% charged	2.5 hrs

Your charger will fully charge in under 3 hours.

NOTE: While the StarLink Premium Mini Charger's on-board battery is charging, indicator lights will default to the hearing aid charging status if hearing aids are placed in the charging slots.

Care for your charger

Cleaning tips

Keep your charger clean. This helps prevent damage from moisture and debris:

- Use the included cleaning tool to clear debris from the charging ports. This is where you insert your hearing aids for charging.
- Do not use water, cleaning fluids or solvents to clean the charging contacts. These can damage your charger.
- Try to keep the lid closed to prevent buildup of dust and debris.

Storage tips

Store your charger in a clean and dry area. This helps preserve the life of your charger and rechargeable hearing aid batteries:

- Choose a dresser or shelf in a room other than a bathroom or kitchen.
- Be sure the storage location is cool to avoid damage. Skip areas with extreme heat like a windowsill or hot car.

Care for your charger

- It's safe to leave your charger plugged in while wearing your hearing aids. But if you won't be using it for an extended period (over a week), remove the power cord from your charger and/or external power source.



Troubleshooting guide

Troubleshooting guide

Problems with your charger? Try these tips. If issues continue, contact your hearing care professional.

Symptom	Possible causes	Solutions
Applicable charger: <i>StarLink Premium Mini Charger</i>		
All 4 indicator lights are blinking (long-short-long). 	Electrical issue: The temperature is outside the charging limits for your charger's battery.	Return the charger to a safe charging temperature. Your charger should automatically resume charging its battery.
	Electrical issue: A charging circuit fault has occurred.	If your charger is plugged in to an external power source: <ol style="list-style-type: none">1. Unplug your charger.2. Plug it back in again. If neither solution resolves the issue, contact your hearing care professional for help.

Troubleshooting guide

Symptom	Possible causes	Solutions
Applicable chargers: <i>StarLink Charger & StarLink Premium Mini Charger</i>		
Left indicator light is blinking. 	Left hearing aid has an electrical issue. (This can prevent charging.)	Contact your hearing care professional for help.
	Charger has lost or cannot establish communication with the hearing aid.	<ol style="list-style-type: none">1. Take your left hearing aid from the charging slot.2. Return it to the charging slot.
Right indicator light is blinking. 	Right hearing aid has an electrical issue. (This can prevent charging.)	Contact your hearing care professional for help.
	Charger has lost or cannot establish communication with the hearing aid.	<ol style="list-style-type: none">1. Take your right hearing aid from the charging slot.2. Return it to the charging slot.

Troubleshooting guide

Symptom	Possible causes	Solutions
Indicator light remains OFF when hearing aid is placed into the charging slot.	Applicable charger: <i>StarLink Premium Mini Charger</i>	
	Charger battery is drained.	<ol style="list-style-type: none"> 1. Connect the power cord to your charger. 2. Plug your charger into an external power source (e.g., a wall outlet). The charger indicator lights will turn solid for 10 seconds and then transition to charging status.
	Applicable chargers: <i>StarLink Charger & StarLink Premium Mini Charger ONLY if using USB-C power cord</i>	
	Charger is not plugged into an external power source or a working external power source.	<p>Test another external power source to ensure your charger has power (e.g., a wall outlet or other power supply).</p> <p>No other power source? Turn OFF your hearing aid by pushing and holding the user control for 3 seconds.</p>

Troubleshooting guide

Symptom	Possible causes	Solutions
Applicable chargers: <i>StarLink Charger & StarLink Premium Mini Charger</i>		
Indicator light remains OFF when hearing aid is placed into the charging slot.	Hearing aid is in the wrong position in the charging slot.	<ol style="list-style-type: none">1. Take your hearing aid from the charging slot.2. Return it to the charging slot.3. Ensure proper seating on charging slot.
	Charger failure.	Contact your hearing care professional for help.
Applicable charger: <i>StarLink Premium Mini Charger</i>		
Indicator lights turn OFF while charging cordless.	Hearing aids have finished charging, charger has moved to "power save" mode.	<p>Refresh the charging LEDs:</p> <ol style="list-style-type: none">1. Take your hearing aid from the charging slot for 3 seconds.2. Return it to the charging slot. The indicator lights should glow for 10 seconds.

Troubleshooting guide

Symptom	Possible causes	Solutions
Applicable chargers: <i>StarLink Premium Mini Charger</i>		
Indicator lights turn ON briefly and then turn OFF.	Charger battery is drained.	<ol style="list-style-type: none">1. Connect the power cord to your charger.2. Plug your charger into an external power source (e.g., a wall outlet). The charger indicator lights will turn solid for 10 seconds and then transition to charging status.

Additional guidance

- Intended use
- FCC information
- Regulatory information

Intended use

Intended Use

These hearing aid chargers are intended to charge lithium-ion rechargeable hearing aids, and are to be used with the patient's selected hearing aid solution. For information about your hearing aid, please consult the hearing aid specific user manual.

Your charger is designed to operate in public and residential environments and are designed to comply with international Electromagnetic Compatibility emissions and immunity standards for medical devices. However, it is still possible that you may experience interference caused by power line disturbances, airport metal detectors, electromagnetic fields from other medical devices, radio signals and electrostatic discharges.

If you use other medical devices or wear implantable medical devices such as defibrillators or pacemakers and are concerned that your hearing instruments might cause interference with your medical device, please contact your physician or the manufacturer of your medical device for information about the risk of disturbance.

Your charger should not be used during an MRI procedure or in a hyperbaric chamber or other oxygen-rich environments.

Your charger is not formally certified to operate in explosive atmospheres such as may be found in coal mines or certain chemical factories.

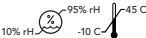
 Your charger should be stored and transported within the temperature, humidity, and pressure ranges of -10°C (14°F) to +45°C (113°F), 10%-95% rH, and 70 kPa – 106 kPa (equivalent to altitudes from 1,200 ft (380 m) below sea level to 10,000 ft (3,000 m)).

The charging temperature range is between 10°C (50°F) and 40°C (104°F) and between 10%-95% RH and 70 kPa-106 kPa.

CAUTIONS:

- If the product is hot, do not touch it until cool.
- If the product is not working, do not disassemble. Due to a shock hazard, contact the manufacturer and send the device in for repair.
- Keep out of reach from children. Do not ingest anything in the package, including desiccant, cleaning tool, etc.
- Any cords and AC adapters must be approved or listed by a Nationally Recognized Testing Laboratory.

Clinical benefit

The charger itself does not provide a direct clinical benefit. An indirect clinical benefit is provided by enabling the parent device (rechargeable hearing aids) to achieve their intended purpose.

Intended use

We are required by regulations to provide the following warnings:

⚠ WARNING: Use of wireless charger directly next to other electronic equipment should be avoided because it could result in improper performance. If such use is necessary, note as to whether your hearing aids and the other equipment are operating normally.

⚠ WARNING: Use of accessories, components or replacement parts other than those provided by the manufacturer of your charger could result in increased electromagnetic emissions and decreased electromagnetic immunity and could result in degradation of performance.

⚠ WARNING: If Portable Radio Frequency communications equipment is used closer than 30 cm (12 inches) from your charger, degradation of the performance of your charger could result. If this occurs, move away from the communications equipment.

DO NOT OPEN CHARGER, NO USER-SERVICEABLE PARTS INSIDE

The StarLink Chargers and StarLink Premium Mini Chargers have a rating of IP 22 per IEC 60529. This means the unit is protected against solid objects over 12 mm, such as fingers and falling water drops, such as condensation.

Do not connect the charger to any devices not described in this user manual.

The service life of both the StarLink Chargers and StarLink Premium Mini Chargers is 3 years.

The StarLink Chargers and StarLink Premium Mini Chargers have been tested to, and have passed, the following emissions and immunity tests:

- IEC 60601-1-2 radiated and conducted emissions requirements for a Group 1 Class B device as stated in CISPR 11.
- Harmonic distortion and voltage fluctuations affecting the power input source as stated in Table 2 of IEC 60601-1-2.
- RF radiated immunity at a field level of 10 V/m between 80 MHz and 2.7 GHz as well as higher field levels from communications devices as stated in Table 9 of IEC 60601-1-2.
- Immunity to power frequency magnetic fields at a field level of 30 A/m and proximity magnetic fields as stated in Table 11 of IEC 60601-1-2.
- Immunity to ESD levels of +/- 8 kV conducted discharge and +/- 15 kV air discharge.
- Immunity to Electrical fast transients on the power input at a level of +/- 2 kV at a 100 Hz repetition rate.
- Immunity to Surges on the power input of +/- 1 kV line to line.
- Immunity to conducted disturbances induced by RF fields on the power input as stated in Table 6 of IEC 60601-1-2.
- Immunity to voltage dips and interruptions on the power input as stated in Table 6 of IEC 60601-1-2.

Intended use

EU ADVERSE EVENT REPORTING

Any serious incident that has occurred in relation to your Starkey device should be reported to your local Starkey representative and the Competent Authority of the Member State in which you are established. A serious incident is defined as any malfunction, deterioration in the characteristics and/or performance of the device, or inadequacy in the device user manual/ labeling which could lead to the death or serious deterioration in the state of health of the user, OR could do so upon recurrence.

FCC information

These devices comply with part 15 of the FCC rules and with ISED Canada license-exempt RSS standards. Operation is subject to the following two conditions: (1) This device may not cause harmful interference, and (2) this device must accept any interference received, including interference that may cause undesired operation of the device.

NOTE: The manufacturer is not responsible for any radio or TV interference caused by unauthorized modifications to this equipment. Such modifications could void the user's authority to operate the equipment.

Regulatory information



Starkey Labs Canada Co.

2476 Argentia Road, Suite 301

Mississauga, ON L5N 6M1

www.starkeycanada.ca



Starkey Laboratories (Germany) GmbH

Weg beim Jäger 218-222

22335 Hamburg

Germany



Waste from electronic equipment must be handled according to local regulations



Consult user manual



Keep dry

Instructions for Disposal of Old Electronics

Starkey Laboratories, Inc. encourages, the EU requires, and your local community laws may require that your StarLink Premium Mini Charger be disposed of via your local electronics recycling/disposal process.

The instructions below are provided for the benefit of disposal/recycling personnel. Please include this manual when disposing of your charger.

FOR DISPOSAL/RECYCLING PERSONNEL ONLY

The StarLink Premium Mini Charger contains a Lithium-Ion Polymer battery. To remove the battery from the charger, follow one of two options:

















Option 1

- Insert pry bars between the plastic and the USB-C metal housing (top and bottom)
- Pry apart to break the seam
- Clip battery wires and dispose battery

Option 2

- Using the style groove as a guide, sever the plastic case on all 4 sides with a dremel blade, ultrasonic knife, hot wire, or band saw blade
- In each case, establish a limit guide so entrance over 3/32 inch beyond the outer shell is prevented
- Clip battery wires and dispose battery

Regulatory information

Symbol	Symbol Meaning	Applicable Standard	Symbol Number
	Manufacturer	BS EN ISO 15223-1:2021	5.1.1
	Authorized representative in the European Community	BS EN ISO 15223-1:2021	5.1.2
	Date of Manufacture	BS EN ISO 15223-1:2021	5.1.3
	Catalogue Number	BS EN ISO 15223-1:2021	5.1.6
	Serial Number	BS EN ISO 15223-1:2021	5.1.7
	Medical Device	BS EN ISO 15223-1:2021	5.7.7
	Keep Dry	BS EN ISO 15223-1:2021	5.3.4
	Temperature Limit	BS EN ISO 15223-1:2021	5.3.7
	Humidity Limitation	BS EN ISO 15223-1:2021	5.3.8
	Caution	BS EN ISO 15223-1:2021	5.4.4
	General warning sign	EC 60601-1, Reference no. Table D.2, Safety sign 2	ISO 7010-W001
	Refer to instruction manual/booklet	EC 60601-1, Reference no. Table D.2, Safety sign 10	ISO 7010-M002
	Collect Separately	DIRECTIVE 2012/19/EU (WEEE)	Annex IX
	Class II equipment	IEC 60417 Reference no. Table D.1	Symbol 9 (IEC 60417-5172)
	Direct current	IEC 60601-1 Reference no. Table D.1	IEC 60417-5031
	Recycling Symbol	European Parliament and Council Directive 94/62/EC	Annex I-VII

StarLink and Starkey are trademarks of Starkey Laboratories, Inc.

©2023 Starkey Laboratories, Inc. All Rights Reserved. 5/23 BKLT3142-01-EN-XX-CA

Patent: www.starkey.com/patents