

TASER 10 VR



QUICK START GUIDE

For detailed user guides, video walkthroughs, and training, go to <https://my.axon.com/s/axon-vr-training> (QR code above).

Simulated weapon

White TASER 10 VR Controllers are only for use in virtual reality (VR) training environments. They neither accept nor fire probes like a duty TASER 10.

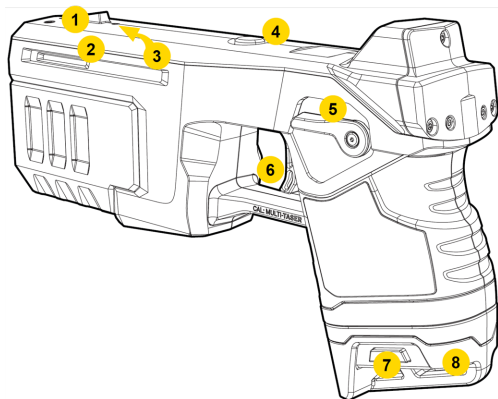



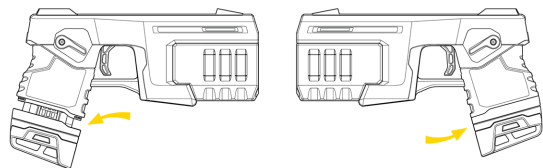

1. Front sight
2. Sidelight LED
3. Pairing LED
4. App button
5. Selector switch
6. Trigger
7. Battery release
8. Battery pack

Battery information

Battery packs are sold separately. The TASER 10 VR Controller (VRC) uses the same battery as a duty TASER 10.



When the battery pack seats properly, the release buttons pop out from a recessed position with two audible clicks. The Sidelight LEDs flashes to

indicate battery level: green  (over 50%), yellow  (50–15%), orange  (14–5%), or red  (<5%). A new battery requires an initial continuous 24-hour charge for proper setup.

The USB connector on the front is only for pairing the controller and headset if wireless pairing is unsuccessful. It's not for charging.

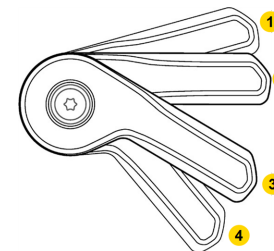

Selector switch and LEDs

Previous TASER devices had a two-position safety: On (Armed) and Off (Safe). The TASER 10 VRC selector switch has different operating modes:



1. Tap up for re-energize (already deployed) or warning tone (not yet deployed)
2. On (Armed)
3. Off (Safe)
4. Hold down (not currently used for VR)

The Sidelight LEDs indicate what state the controller is in:

- If the controller is armed and you pull the trigger, the Sidelights is purple .
- If the controller is disarmed and you pull the trigger, the Sidelights is blue .

To conserve battery, the controller might enter sleep mode, indicated by all LEDs turning off. If this occurs while the device is armed, cycle the selector switch to Off (Safe) and then On (Armed) to reactivate it.



Magazine installation

The controller comes with the magazine already installed and there is no need to remove it. If it needs to be reinstalled:

1. Set the selector switch to Off (Safe).
2. Hold the magazine from the bottom and align the upper guides on the magazine with the rails on the device.
3. Slide the magazine approximately halfway toward the back of the device before pushing upward.
4. Slide the magazine into the TASER VRC until you hear a click.
5. Move the selector switch to On (Armed), then back to Off (Safe).

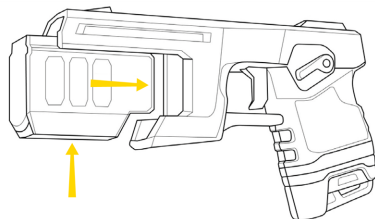

Pair the controller and headset

1. Turn the headset on by pressing the power button for about five seconds. It opens to the Library.
2. Select **Simulator Training** and acknowledge the messages.
3. Move or cycle the selector switch to On to wake up the TASER VRC. The Pairing LED turns blue (if green, it's already paired). Wait three seconds for internal systems to fully power on.
4. Press the App button firmly (so it clicks) until the Pairing LED starts flashing blue, or about three seconds.
5. When the controller and headset are paired, the Pairing LED turns green and Simulator Training launches.

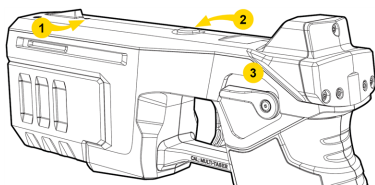

1. Pairing LED
2. App button
3. Selector switch up

The TASER VRC remains paired to the headset even if turned off or the battery is removed.

If pairing fails, the Pairing LED remains blue; cycle the selector switch off/on, wait three seconds, and retry step 4. Holding the App button too long puts the TASER VRC into Sleep mode.

When the Pairing LED is flashing blue and red, the TASER VRC is receiving a firmware update. Do not remove the battery.

Recharge the battery

1. Move the selector switch down to Off (Safe).
2. Press the buttons on each side of the battery pack and remove it from the TASER VRC.
3. Press the battery into the dock. It'll click when correctly seated.

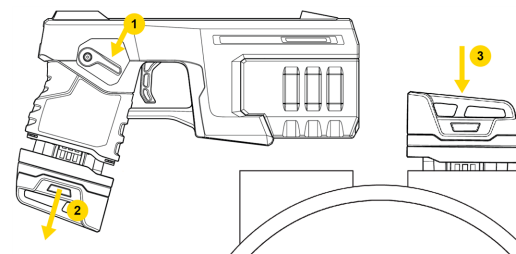

As the battery recharges in a networked dock, updates to your agency settings automatically download and will apply when the battery is used in the TASER VRC.



For detailed user guides, video walkthroughs, and training, go to <http://axon.com/vr-setup> (QR code above).

Simulated weapon

White VR controllers are only for use in virtual reality (VR) training environments. They neither accept ammunition nor fire like a duty weapon.



Controller features

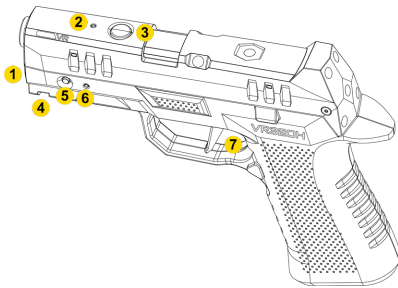



The controller includes a charging cable at the bottom of the box. Features of the controller include:



1. USB charging port (front, not visible)
2. Pairing LED
3. App button
4. Picatinny rail (underneath)
5. Power button
6. Status LED
7. Trigger

Charging information



The controller's charging port is located at the front beside the barrel opening. Charge with any powered USB port. The Status LED blinks white  while charging and turns solid white  at full charge. The controller can't be used during charging.



Whenever powered on, the Status LED flashes to indicate battery level: green  (over 50%), yellow  (50–15%), orange  (14–5%), or red  (<5%).

Trigger and LEDs



If the controller enters sleep mode to conserve battery, all LEDs turn off. If this occurs, press **Power** to reactivate it.

Pair the controller and headset

1. Turn the headset on by pressing **Power** for about five seconds. It opens to the Library.
2. Select **Axon VR Training** and acknowledge the messages to initiate pairing.
3. Press **Power** to wake up the controller. The Pairing LED is blue .
 - If green , it's already paired.
 - If not on, or the Status LED is red , charge the controller prior to pairing.
4. Wait three seconds for internal systems to fully power on.

5. Press **App** firmly (so it clicks) until the Pairing LED starts flashing blue , or about three seconds.
6. When the controller and headset are paired, the Pairing LED turns green .

If pairing fails, the Pairing LED remains blue . If the LED turns off, press **Power** and retry step 4. Holding **App** too long puts the controller into Sleep mode. The controller remains paired to the headset even if turned off.

When the Pairing LED is flashing blue  and red , the controller is receiving a firmware update. Do not press **Power** during the update.

Note: This controller is not used in Community Engagement Training.



For detailed user guides, video walkthroughs, and training, go to <http://axon.com/vr-setup> (QR code above).

Simulated weapon

White VR controllers are only for use in virtual reality (VR) training environments. They neither accept ammunition nor fire like a duty weapon.

Controller features

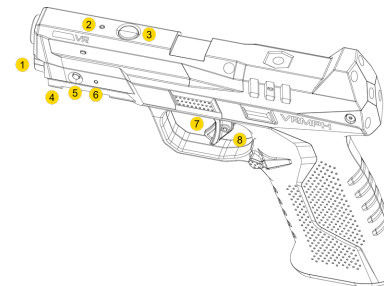

The controller includes a charging cable at the bottom of the box. Features of the controller include:







1. USB charging port (front, not visible)
2. Pairing LED
3. App button
4. Picatinny rail (underneath)
5. Power button
6. Status LED
7. Trigger safety



8. Trigger

Charging information

The controller's charging port is located at the front beside the barrel opening. Charge with any powered USB port. The Status LED blinks white  while charging and turns solid white  at full charge. The controller can't be used during charging.

Whenever powered on, the Status LED flashes to indicate battery level: green  (over 50%), yellow  (50–15%), orange  (14–5%), or red  (<5%).

Trigger and LEDs



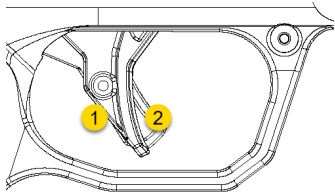

- **Pull the trigger safety:** Status LED is blue .
- **Pull the trigger safety and the trigger:** Status LED is purple .





1. Trigger
2. Trigger safety



If the controller enters sleep mode to conserve battery, all LEDs turn off. If this occurs, press **Power** to reactivate it.

Pair the controller and headset

1. Turn the headset on by pressing **Power** for about five seconds. It opens to the Library.
2. Select **Axon VR Training** and acknowledge the messages to initiate pairing.
3. Press **Power** to wake up the controller. The Pairing LED is blue .
 - If green , it's already paired.
 - If not on, or the Status LED is red , charge the controller prior to pairing.
4. Wait three seconds for internal systems to fully power on.
5. Press **App** firmly (so it clicks) until the Pairing LED starts flashing blue , or about three seconds.

6. When the controller and headset are paired, the Pairing LED turns green .

If pairing fails, the Pairing LED remains blue . If the LED turns off, press **Power** and retry step 4. Holding **App** too long puts the controller into Sleep mode. The controller remains paired to the headset even if turned off.

When the Pairing LED is flashing blue  and red , the controller is receiving a firmware update. Do not press **Power** during the update.

Note: This controller is not used in Community Engagement Training.