

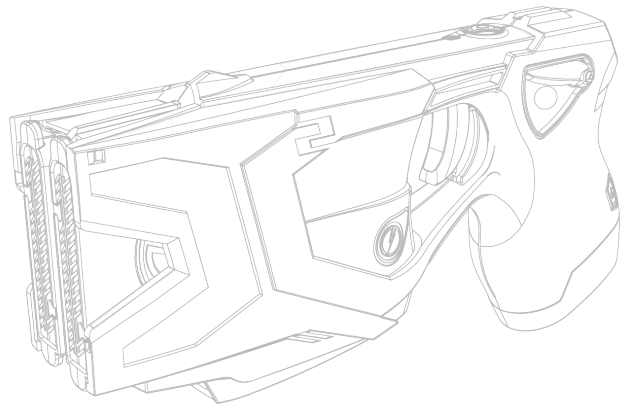

TASER X2 Energy Weapon

User Manual



English

Models 22000, 22001, 22002, 22003, T00074



IMPORTANT SAFETY INSTRUCTIONS

Read all warnings and instructions. Save these instructions.

The most up-to-date warnings and instructions are available at www.axon.com

MMU0037 Rev: T

February 2025

Contents

1	Chapter 1: Warnings
1	Important Safety and Health Information
2	LASER information
3	Use of force policy
3	Firmware update
4	Chapter 2: General information
4	What is the X2 Energy Weapon?
4	Neuromuscular Incapacitation (NMI)
5	Basic X2 Energy Weapon Electrical Theory
6	Chapter 3: X2 Energy Weapon Features
6	Safety
7	Index Finger Rest
7	Arc display/Re-energize/Cartridge advance (ARC) Switch
7	Performance Power Magazine (PPM) Battery Pack
8	Changing the PPM (or Other Battery Pack)
9	Tactical Performance Power Magazine (TPPM) Battery Pack
9	Automatic Shut-Down Performance Power Magazine (APPM) Battery Pack
9	Trigger-Initiated Shut-Down Only Option – ARC Switch Override
10	Trigger- and ARC Switch-Initiated Shut-Down Option – Hard Stop
10	Replacing the APPM with a Different Battery Pack
10	Signal Performance Power Magazine (SPPM) Battery Pack <small>(Model T00074)</small>
11	Automatic Shut-Down Option
11	Continued SPPM Transmit in Safe Option
11	Signal Mute Mode
11	Updating the SPPM Firmware
12	Near Field Communications (NFC) Tag

12	Advanced Central Information Display (CID)
12	Cartridge Icons
13	System Status Icons
14	Operating Mode Icons
14	Battery Level Icons
15	Sample CID Displays
16	Probe-Deployment Mode
16	Spark Duration
16	ARC switch
17	Top LASER
17	Bottom LASER
17	Mechanical Sights
18	LED Flashlight
18	Selector Switch
18	Trigger Switch
19	Semi-Automatic Mode
22	Manual Mode
22	Arc display/Re-energize/Cartridge advance (ARC) Switch Functions
22	Trigger Functions
26	Configuring the X2 Energy Weapon and Viewing the System Status
26	Setting the Sighting Options
26	Viewing the System Information
27	Viewing the Battery Pack Information
28	Enabling SPPM Signal Mute Mode
29	Chapter 4: Cartridges and Energy Weapon Operation
29	Remove the Shipping Cover from the Smart Cartridge
30	X2 Smart Cartridge Characteristics
31	Standard-Range (15-foot/4.6-meter and 25-foot/7.6-meter) Smart Cartridges
31	Long-Range (35-foot/10.7-meter) Smart Cartridges
31	Simulation Smart Cartridges
31	Inert Resettable Simulator Cartridges
31	Smart Cartridges General Instructions
32	AFID
33	Load the Smart Cartridges
35	Cartridge Release Button





35	Unloading
37	Selecting Cartridges
37	Aiming and Probe Placement
38	Audible Pulse Rate Changes
38	Potential Causes of Reduced or No Effectiveness
39	Warning Arc Display
40	Electrodes
40	Drive-Stun Backup
41	Recommended Drive-Stun Areas for Maximum Effect
42	Chapter 5: Maintenance/Troubleshooting
42	ARC Switch-Initiated Function test
43	Trigger-Initiated Function Test
43	What to Do Following Energy Weapon Use
43	Considerations for Handling Used Probes
44	Effects on Animals
44	Police/Military K-9 Caution
44	Downloading Firmware Revisions
44	Dataport Download Kit
45	USB Connection Status
45	Evidence Sync Offline Software
45	Trilogy Log
45	Event Log
46	Pulse Log
46	Engineering Log
46	Time Synchronization
47	X2 Energy Weapon Maintenance and Care
47	Dropped or Wet X2 Energy Weapon
48	Online Troubleshooting Guide
49	Product Returns
50	Chapter 6: Optional Accessories
50	Axon Evidence Services
50	Evidence Sync Software for Offline Mode
50	TASER CAM HD Recorder
50	Holsters

51	Chapter 7: Additional Items
51	Additional Information
51	Axon Academy
51	Medical Research
52	Radio Waves
53	CE Declaration of Conformity
53	Compliance Marks

Chapter 1: Warnings

Important Safety and Health Information

Read, understand and follow the most current product warnings, safety instructions, and training materials. All product warnings are not included in this Manual. A Product Warnings document is included with this Energy Weapon and the most current warnings are posted on our website at www.axon.com. The most current training materials are available by contacting Axon’s Training Department. Do not attempt to use this energy weapon until you have completed training with an Axon Enterprise, Inc. Certified TASER Instructor.

 WARNING!	
	<p>Complete Training First Significant differences exist between each of the TASER energy weapon models. Do not use or attempt to use any energy weapon model unless you have been trained and certified by a Certified TASER Instructor on that particular model.</p>
	<p>Read and Obey Read, study, understand, and follow all instructions, warnings, information, training bulletins and relevant TASER training materials before using the TASER X2 energy weapon. Failure to comply with the product instructions, warnings, information, training bulletins, and TASER training materials could result in death or serious injury to the user, force recipient, and others.</p>
	<p>Obey Applicable Laws Use of energy weapons must be legally justified and comply with applicable federal, state, and local laws and regulations. The decision to use an energy weapon in a particular manner or circumstance must follow applicable law enforcement agency Guidance.</p>
<div style="border: 1px solid black; padding: 5px; display: inline-block;">  <div style="margin-left: 10px;"> <p style="background-color: #f4a460; color: white; padding: 2px;">WARNING</p> <p>Energy Weapon</p> <ul style="list-style-type: none"> • Can temporarily incapacitate target. • Can cause death or serious injury. • Follow warnings, instructions and all laws • Comply with current training materials and requirements. • See www.axon.com </div> </div>	

In probe-deployment mode, TASER energy weapons are designed to temporarily incapacitate a person from a safer distance while reducing the likelihood of serious injuries or death. When used as directed, TASER energy weapons have been found to be safer and more effective than other traditional use-of-force tools and techniques. However, it is important to remember that the use of force and physical incapacitation, by their very nature, involve risk that someone will get hurt or may even die

from factors that include, but are not limited to: physical resistance, exertion, individual susceptibilities, and/or unforeseen circumstances. Any use of force, including the use of an energy weapon, or physical exertion involves risks that a person may get hurt or die.

For a full list of current warnings, visit www.axon.com.

LASER information

⚠ WARNING!

LASER RADIATION DO NOT STARE INTO BEAM CLASS 2 LASER PRODUCT		LASER 2	
--	--	--------------------	---

⚠ WARNING!

LASER RADIATION AVOID DIRECT EYE EXPOSURE CLASS 3R LASER PRODUCT		⚠ CAUTION LASER 3R	
--	--	-----------------------------------	---

⚠ WARNING!

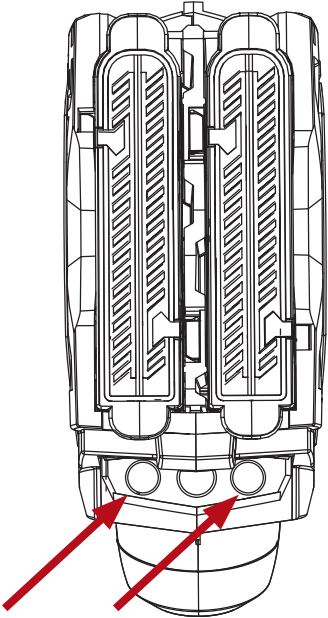
AVOID EXPOSURE - LASER RADIATION IS EMITTED FROM THESE APERTURES	
--	--

⚠ CAUTION! RADIATION EXPOSURE

Use of controls or adjustments or performance of procedures other than those specified herein may result in hazardous radiation exposure.

Use of force policy

Each agency is responsible for creating its own use-of-force policy and determining how TASER energy weapons fit into their use-of-force matrix based on legal and community standards. Make sure your agency has a use-of-force policy that addresses TASER energy weapon use and that this policy is clearly addressed during end-user training.

Firmware update

Before using your X2 energy weapon, confirm with your TASER Program Coordinator or other qualified person that the X2 firmware has been updated.

Chapter 2: General information

What is the X2 Energy Weapon?

The TASER X2 energy weapon is a firmware upgradable, two-shot weapon manufactured by Axon Enterprise, Inc.

The X2 energy weapon uses two replaceable Smart Cartridges containing compressed nitrogen to deploy two small probes that are attached to the X2 energy weapon by insulated conductive wires. The X2 energy weapon transmits electrical pulses along the wires and into the body which are designed to affect the sensory and motor functions of the peripheral nervous system and cause involuntary muscle contractions. The cartridges are available with various wire lengths from 15 feet to 25 feet (4.6 meters to 7.6 meters). The X2 energy weapon deploys the cartridges one at a time. It is possible to apply energy beyond the initial burst to a deployed cartridge without deploying the remaining cartridge. It is also possible to apply a Warning Arc display or drive-stun without deploying any of the cartridges loaded in the energy weapon.

The X2 energy weapon has an internal memory that stores the operating firmware and a record of every deployment. See *Trilogy Log* (Chapter 5) for more details. The X2 energy weapon's Trilogy log can be downloaded to Axon Evidence (Evidence.com) services. Those who do not have an Axon Evidence account can use Offline Evidence Sync software to download a simplified log to a local computer.

The X2 energy weapon has an estimated useful life of five years.

Neuromuscular Incapacitation (NMI)

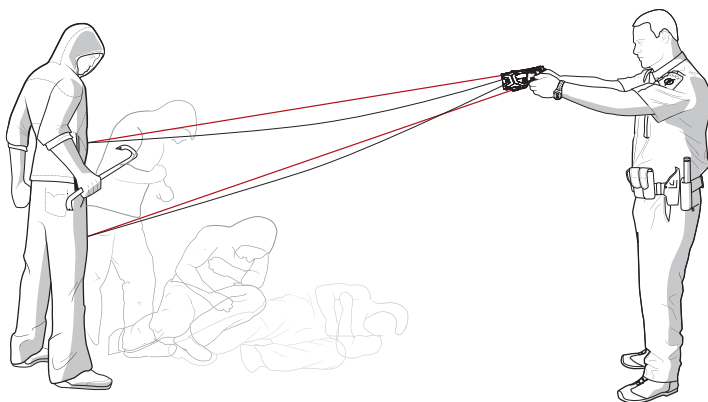

TASER technology is designed to use electrical impulses similar to those in your body's nervous system to cause stimulation of the sensory and motor nerves. Neuromuscular incapacitation (NMI) occurs

when an energy weapon is able to cause involuntary stimulation of both the sensory nerves and the motor nerves. It is not dependent on pain and can be effective on subjects with a high level of pain tolerance.

Previous generations of stun guns primarily affected the sensory nerves only, resulting in pain compliance. A subject with a very high tolerance to pain (e.g., a drug abuser, person in serious psychological distress, or a trained, focused fighter) might not be affected by the pain or might be able to fight through the pain of a traditional stun gun.

Basic X2 Energy Weapon Electrical Theory

- Electricity must be able to flow between the probes or the electrodes to deliver an electrical charge and will generally follow the path of least resistance.
- The greater the spread between the probes on the target, generally the greater the effectiveness.
- Electricity will generally not pass to others in contact with the subject unless contact is made directly between or on the probes, or the wires are touched.
- Electricity can arc through most clothing, and even some bullet-resistant materials.
- Exposure to water will not increase the power to the subject. The delivered electrical charge is fixed inside the TASER energy weapon, and will not increase significantly even with environmental changes.
- The X2 energy weapon's Rotational-Pulse Drive technology rotates discharges across the two cartridge bays. This alternation of pulsed output across multiple cartridges allows a single X2 energy weapon to affect up to two subjects simultaneously but was primarily designed to give the operator an immediate back up shot in case of a miss.
- The Rotational Pulse Drive technology supports cross connection, or X-Connect technology, which can make the X2 energy weapon effective even if some probes do not hit the target. As long as one top probe and one bottom probe hit the subject, the circuit can be completed, even if the probes were deployed from different cartridges.
- The Current Metering technology is designed to deliver optimal output.

Chapter 3: X2 Energy Weapon Features

Get to Know the X2 energy weapon.

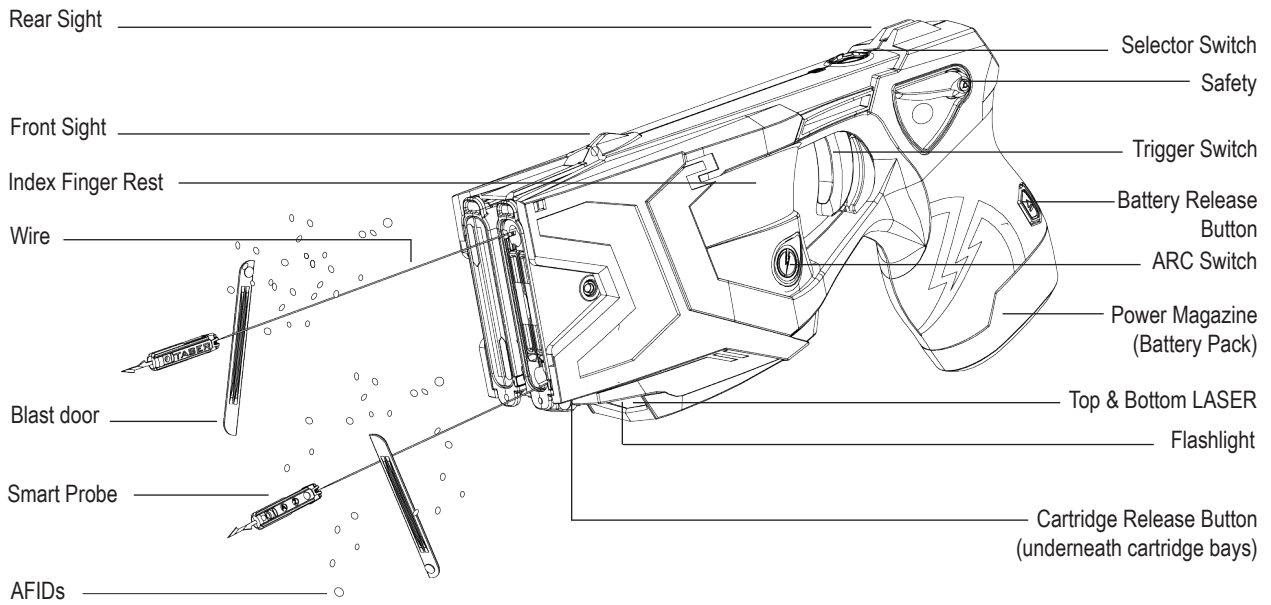

Safety

Ambidextrous safety can be operated from either side of the energy weapon.

- Safety down (SAFE).
- Safety up (ARMED) and ready to deploy.

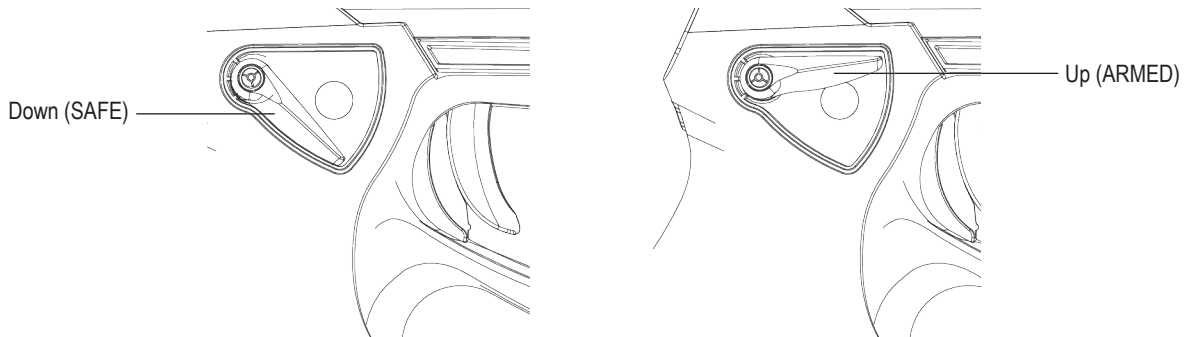

- Do not block the safety on one side of the X2 energy weapon while attempting to move it on the other side. This can break the safety and disable the energy weapon.
- If the X2 energy weapon's safety is left in the up (ARMED) position for more than 20 minutes, the system goes into low power mode to reduce the amount of power consumed, and the energy weapon will not fire. Although the energy weapon will not fire, power is still consumed and will eventually drain the battery if the safety remains in the ARMED position. To re-arm the energy weapon, move the safety to the down (SAFE) position, and then move it back to the up (ARMED) position.

Index Finger Rest

On each side of the X2 energy weapon is an ergonomically designed rest upon which to place the tip of your index finger when you are not pulling the trigger switch or pressing the ARC switch.

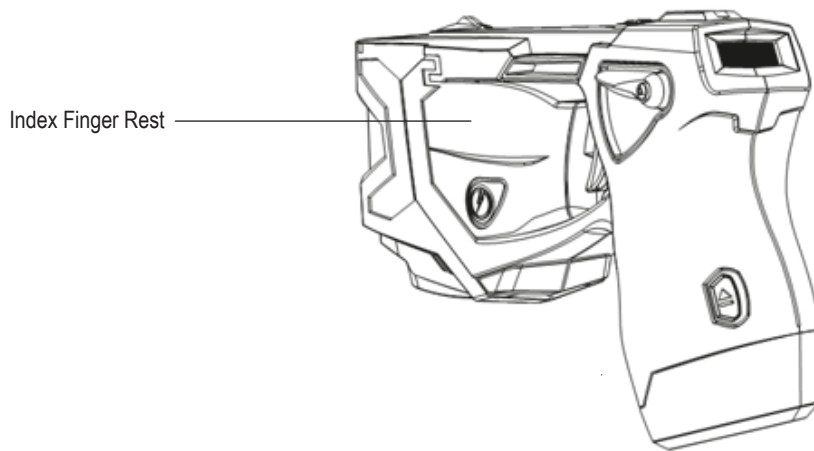

Arc display/Re-energize/Cartridge advance (ARC) Switch

The ARC switch is used to employ a Warning Arc display, select cartridges, and select menu items during system configuration and option selection. ARC switch functions are described in *Arc display/Re-energize/Cartridge advance (ARC) Switch Functions* and *Configuring the X2 Energy Weapon and Viewing the System Status*.

Performance Power Magazine (PPM) Battery Pack

The Performance Power Magazine is a lithium energy cell power supply system for the X2 energy weapon.



Note: X2 battery packs will not work with the TASER 7, X3, or X26 energy weapons. Battery packs designed for the X26P energy weapon will work in the X2 energy weapon.

Battery packs should be stored in their original packaging, including the desiccant bag, until they are to be used. Do not store the PPM anywhere that the gold contacts on the top of the PPM may touch metal objects. If you cause an electrical short between these contacts, the short will drain the lithium energy cells and may cause the pack itself to become dangerously hot.

The PPM battery has enough power for approximately 500 five-second trigger-initiated discharges or 250 five-second ARC switch-initiated discharges, depending on temperature, environment, use of the flashlight, and other factors. The PPM battery will deplete faster in colder weather than warm weather. Likewise, the battery will deplete faster with the flashlight active.

For more information on installing the PPM, see *Changing the PPM (or Other Battery Pack)*.

Note: Other battery pack options are available for the X2 energy weapon. See *Tactical Performance Power Magazine (TPPM) Battery Pack*, *Automatic Shut-Down Performance Power Magazine (APPM) Battery Pack*, and *Signal Performance Power Magazine (SPPM) Battery Pack (Model T00074)* for more information.

Changing the PPM (or Other Battery Pack)

- 1 Point the energy weapon in a safe direction.
- 2 Move the safety to the down (SAFE) position.
- 3 Safely remove the Smart Cartridges. See *Unloading* (Chapter 4) for more information.
- 4 To remove the PPM, depress the PPM release button and remove the PPM from the handle of the energy weapon.

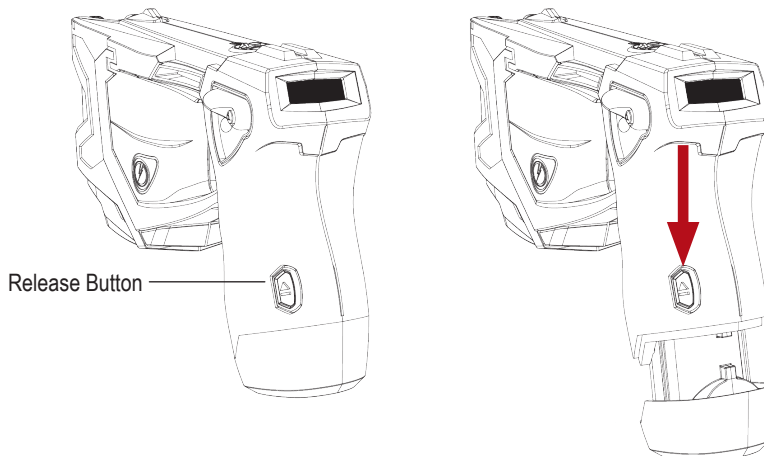

- 5 Inspect the battery contacts. Ensure that they appear in working order and are free from dirt or other residue that may interrupt the battery connection to the energy weapon.
- 6 Install the new PPM and ensure that it is fully inserted into the X2 energy weapon. Apply sufficient force to ensure the PPM is fully seated. When the PPM battery pack seats properly, the PPM release button should pop out from the recessed position with an audible click.

Tactical Performance Power Magazine (TPPM) Battery Pack

The optional TPPM has an extension to provide a larger grip on the energy weapon. The TPPM does not hold an extra cartridge.



Automatic Shut-Down Performance Power Magazine (APPM) Battery Pack

The optional APPM is a modified battery pack that shuts down the output of the X2 energy weapon after five seconds and also contains a built-in speaker that alerts you to the impending shut down. The APPM icon will be displayed in the top left corner of the CID when the energy weapon detects that an APPM is installed.

Under stressful situations, audio exclusion might prevent you from hearing the alert from the APPM.

There are two ways your agency can configure your energy weapon to work with the APPM. With the default option, shut down will occur five seconds after a trigger-initiated energy burst, but ARC switch functioning will not be affected. With the other option, shut down will occur after five seconds whether you press the trigger or the ARC switch. To use the second option, the agency must configure the energy weapon through Axon Evidence.

Trigger-Initiated Shut-Down Only Option – ARC Switch Override

The APPM provides an audible beeping alert for the last two seconds of a trigger-initiated cycle before automatically shutting down the cycle. After a 5-second deployment duration, the energy burst will stop even if your finger is still pulling the trigger switch. The audible beeping alert will continue to sound until the trigger switch is released. To re-energize the deployed cartridge, first ensure that your finger is off the trigger switch, and then press the ARC switch.

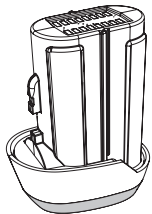

With the APPM's ARC switch override option, pressing the ARC switch before the 5-second, trigger-initiated cycle has ended and holding the ARC switch will cause the cycle to continue past the 5-second limit.

Trigger- and ARC Switch-Initiated Shut-Down Option – Hard Stop

The APPM provides an audible beeping alert for the last two seconds of a trigger- or ARC switch-initiated cycle before automatically shutting down the cycle. After a 5-second deployment duration, the energy burst will stop even if your finger is still pulling the trigger switch or pressing on the ARC switch. The audible beeping alert will continue to sound until the trigger switch or ARC switch is released. To reenergize the deployed cartridge, first ensure that your finger is off the trigger switch, and then press the ARC switch. To reenergize the ARC switch, remove your finger from the ARC switch and re-press the ARC switch.

Replacing the APPM with a Different Battery Pack

Your energy weapon will recognize the APPM as a unique type of battery pack. If you remove the APPM and replace it with a different type of battery pack, the X2 energy weapon will return to its normal configuration. That is, there will no longer be an audio alert, and the energy cycle will continue after five seconds if your finger is still holding down the trigger or ARC switch. Always confirm that the energy weapon performs as expected before returning it to duty after changing any battery pack.

Remove the cartridges before testing the energy weapon function. See *Unloading* (Chapter 4) for more information.

Signal Performance Power Magazine (SPPM) Battery Pack (Model T00074)

The optional Signal Performance Power Magazine (SPPM) is a battery pack designed to work with devices that are equipped with Axon Signal technology.

When an X2 is equipped with an SPPM battery pack, moving the energy weapon's safety to the up (ARMED) position causes the SPPM to send a signal. Upon receipt of this signal, a compatible device can perform a programmed response.

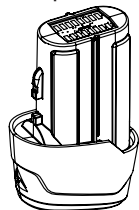

Note: Your energy weapon must have firmware version 4.032 or greater to make use of the SPPM's special features. Without the firmware update, the SPPM only functions as a battery pack like the PPM. Evidence Sync version 3.15.30 or greater is required to configure the SPPM. See the *Evidence Sync User Manual* for more information on firmware updates.

The SPPM transmission begins after the safety is moved to the up (ARMED) position. The signal has a range of up to 30 feet (9.1 meters) line-of-sight.

The SPPM icon will be displayed in the top left corner of the CID when the SPPM has started transmitting the energy weapon status (see the table below).

These are the types of information the SPPM transmission sends:

Event	Description
ARMED event	The safety was moved to the up (ARMED) position.

Event	Description
ARMED + 10 seconds	Ten seconds have elapsed since the safety was moved to the up (ARMED) position.
Trigger event on bay 1	The trigger was pressed with cartridge bay 1 selected.
Trigger event on bay 2	The trigger was pressed with cartridge bay 2 selected.
ARC event	An ARC switch was pressed long enough to initiate a spark.
Signal Mute Mode	Signal Mute Mode has been activated by the user.

Automatic Shut-Down Option

The SPPM can enable the automatic shut-down feature when used with an energy weapon. The X2 will function the same way as if it were equipped with the APPM battery pack. See *Automatic Shut-Down Performance Power Magazine (APPM) Battery Pack* for more information. To enable the automatic shut-down feature, the agency must configure the energy weapon through Axon Evidence.

Continued SPPM Transmit in Safe Option

The X2 energy weapon can be configured to remain powered after the safety is placed in the down (SAFE) position, which allows the SPPM to finish the transmission of any pending status for the full 30 seconds. The CID will continue to display the SPPM icon and display a message "DO NOT REMOVE BATTERY." If the safety is placed in the up (ARMED) position while the device is still sending a Signal transmission, the 30-second timers for each status event will be restarted. Do not remove the SPPM from the energy weapon until the device has finished its Signal transmission and the CID goes blank. To enable the Transmit in Safe feature, the agency must configure the energy weapon through the Axon Evidence website. Enabling this setting will decrease expected battery lifetime firings.

Signal Mute Mode

If your energy weapon is equipped with an SPPM battery back, Signal Mute Mode can be enabled to NOT alert Axon cameras to record. This may be useful when performing a function test. See *ARC Switch-Initiated Function test* and *Trigger-Initiated Function Test* (Chapter 5) for more information. Mute Mode is enabled by the user when the energy weapon is in configuration mode; see *Enabling SPPM Signal Mute Mode*. The device will return to normal operation after the safety is placed in the down (SAFE) position. Any pending 30-second transmissions will be discontinued.

Updating the SPPM Firmware

To update the SPPM firmware, the device must be connected to a TASER central device over the air (OTA). The energy weapon sends a command to the SPPM to start a transmission for this connection when the energy weapon is in configuration mode. With the safety in the down (SAFE) position, press the selector switch on the top of the X2 energy weapon. See *Configuring the X2 Energy Weapon and Viewing the System Status* for more information. After a connection with a central device has been established, the CID will change to display the SPPM battery icon and a message "DO NOT REMOVE BATTERY." Once the connection to the central device has ended, the energy weapon will return to the standard selector mode menu or the energy weapon will exit configuration mode.

Near Field Communications (NFC) Tag

On one side (as shown) or the bottom of the SPPM is an NFC tag that can be scanned by an NFC-capable smart device equipped with the Axon Device Manager application to register, assign, or reassign the battery pack. For more information see *Axon Device Manager for Android Guide* or *Axon Device Manager for iOS Guide*, as appropriate.

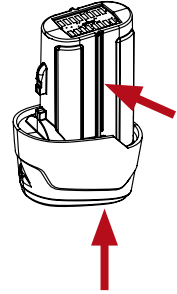

Advanced Central Information Display (CID)

The Advanced CID is a monochrome organic light emitting diode (OLED) on the back of the X2 energy weapon that provides information about the energy weapon. When the safety is moved into the up (ARMED) position, the CID will display the cartridge bays and battery status.

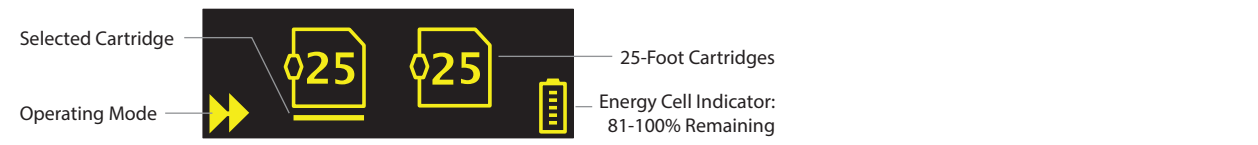

Cartridge Icons



Left to right: 15-, 25-, and 35-foot live cartridges. These cartridges have not been deployed.

Note: The 35-foot cartridges for the X2 were discontinued in 2017. Thus any still in existence are expired and should be removed from service.



Training simulator cartridges (blue, red, or purple blast doors) will display with a yellow icon.

Loading training cartridges into the X2 energy weapon will not affect the energy weapon's ability to deploy. If both live and training cartridges are loaded in the X2 energy weapon, both firing bays remain active. Loading a training cartridge into an X2 energy weapon will not lock a live cartridge that is also loaded in the energy weapon.



After a cartridge has been expended, the cartridge deployed icon is displayed.



If no cartridge is loaded in the cartridge bay, the space otherwise occupied by a cartridge icon will be blank.



If something is wrong with the cartridge, the cartridge bay error icon is displayed. The cartridge might not deploy. See *Load the Smart Cartridges* (Chapter 4) for instructions on loading and unloading Smart Cartridges from an X2 energy weapon.



When the energy weapon is in the Semi-Automatic mode, the loaded cartridge icon indicates that the next trigger pull will deploy a cartridge.

System Status Icons

The system status icons are designed to inform you of a fault in the energy weapon. It is a fault indicator only, and it is the user's responsibility to heed the fault indicators, conduct proper maintenance and repair, and ensure that the energy weapon is working properly before any use. Failure to heed the system status icons could cause serious injury or death.

All faults are recorded in the X2 energy weapon's Engineering log.



Major Fault indication. A yellow triangle in the upper-right side of the CID indicates that the logging, date and time functions, or ability of the energy weapon to read the PPM information are not working properly. The energy weapon will still produce an electrical output (e.g., the energy weapon should still arc and deploy cartridges), but the accountability functions are compromised.

Move the safety to the down (SAFE) position and then to the up (ARMED) position; the fault may clear.

Whether the fault clears or not, it will be recorded in the Engineering log. If the fault does not clear, do NOT attempt to use the energy weapon. The energy weapon may need to be repaired or replaced. See *Product Returns* (Chapter 5) for instructions.



Critical Fault Indication. A yellow stop sign in the upper-right side of the CID indicates a system failure.

Critical faults are rare. Do NOT attempt to use the energy weapon. The energy weapon may need to be repaired or replaced. See *Product Returns* (Chapter 5) for instructions.

Note: If a fault icon appears in the position normally associated with the cartridge status icon, this indicates a fault with a cartridge and not a critical energy weapon fault. Replace the cartridge and see if the icon goes away. See *Unloading* (Chapter 4) for instructions on loading and unloading Smart Cartridges from an X2 energy weapon.



Invalid Battery Pack. If you see a blinking exclamation point and battery icon, this indicates that the energy weapon did not recognize the battery correctly. Remove the battery pack and reinsert it. If the error is still present, try another battery pack. If the icon still displays, the energy weapon should be serviced. See *Product Returns* (Chapter 5) for instructions.



An APPM battery pack is installed in the energy weapon. See *Automatic Shut-Down Performance Power Magazine (APPM) Battery Pack* for more information.



A TASER CAM HD recorder is installed in the energy weapon. See the *TASER CAM HD Operating Manual* for more information.



A TASER CAM HD recorder with the automatic shutoff (AS) feature is installed in the energy weapon. The recorder offers an audio warning and shut-down feature like that of an APPM battery pack. See *TASER CAM HD Operating Manual* for more information.



An SPPM battery pack is installed in the energy weapon. See *Signal Performance Power Magazine (SPPM) Battery Pack (Model T00074)* for more information.



An SPPM battery pack is installed in the energy weapon, and the energy weapon is in Mute Mode. See *Enabling SPPM Signal Mute Mode* for more information.



When you plug the USB download cable into the X2 energy weapon, the USB connection status icon and device serial number will appear. See *USB Connection Status* (Chapter 5) for more information.



When there is an SPPM transmission in the safe mode or the SPPM is connecting for updates, the warning DO NOT REMOVE BATTERY is displayed.

Operating Mode Icons



This is the icon for the Semi-Automatic mode. The energy weapon is shipped in Semi-Automatic mode.



This is the icon for the Manual mode.

Battery Level Icons

When the safety is in the up (ARMED) position, the CID will display the percentage of battery power remaining. Remaining capacity will display in 20-percent increments.

When the battery level drops below 20 percent, Axon Enterprise recommends that the battery pack be replaced.

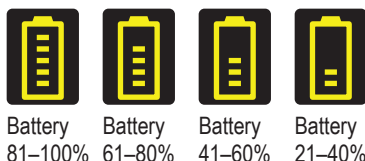

If the battery capacity is at 1–10 percent, the CID will flash the warning **LO BATT** on the CID when the safety is moved to the up (ARMED) position when using any PPM type. The LO BATT warning will be displayed when the battery capacity is between 1–40 percent for TASER CAM HD.



Battery
0–20%
Blinking

If the battery capacity is at 1–20 percent, this icon displays in the lower-right portion the CID.



When the TASER CAM HD battery is depleted, the CID will flash the warning **RECHARGE BATTERY** on the CID when the safety switch is cycled to the up (ARMED) position. The weapon will not discharge. The weapon will shut down after the safety is moved upward.



When using any PPM type battery pack that is depleted, the CID will flash the warning **CHANGE BATTERY** on the CID when the safety is cycled to the up (ARMED) position. The weapon will not discharge. The weapon will shut down after the safety is moved upward.

Sample CID Displays

The CID below shows the X2 energy weapon loaded with a 25-foot and another cartridge. The 25-foot cartridge is selected. (The leftmost, active cartridge is always selected by default.) The battery is 61–80 percent full, and the Semi-Automatic mode icon displays. There is a cartridge fault.



The CID below shows an X2 energy weapon with a battery 61–80 percent full. Only one cartridge is loaded, and the Semi-Automatic mode icon displays.



The CID below shows the Semi-Automatic mode icon and a battery that is 41–60 percent full. The first cartridge has been deployed, and the second cartridge is selected.



The CID below shows the Semi-Automatic mode icon and a battery that is 81–100 percent full, loaded with 25-foot cartridges. The left cartridge is selected; it will be deployed when the trigger is pulled.



The CID below shows the Semi-Automatic mode icon, with two 25-foot training cartridges, and a battery that is 21–40 percent full. The left cartridge is selected.



The CID below shows the Semi-Automatic mode icon, with one expended cartridge, one 25-foot cartridge that is currently selected, a battery at 41–60 percent capacity, and an APPM battery pack installed.



The CID below shows the manual mode icon, with two 25-foot cartridges, a battery at 81–100 percent capacity, and a TASER CAM HD recorder installed.



The CID shows the Semi-Automatic mode icon, two 25-foot cartridges a battery at 81–100 percent capacity, and an SPPM battery pack installed.



Probe-Deployment Mode

When the X2 energy weapon trigger switch is pulled and then released, it delivers an automatic 5-second Precision Shaped Pulse deployment. The cycle continues for five seconds (unless the safety is moved to the down [SAFE] position during the cycle).

In probe-deployment mode, the CID display shows the deployment cycle duration for the most recent cartridge deployed. If you deploy a second Smart Cartridge a few seconds later (while the first cycle is running), the CID will stop showing data for the first cartridge (though the first cartridge will still complete its deployment cycle) and start displaying the deployment cycle duration for the second cartridge.

The cycle can be stopped at any time by moving the safety to the down (SAFE) position. If both cartridges are cycling and the safety is moved to the down (SAFE) position, then the electrical cycle will stop for BOTH cartridges.

Spark Duration

The CID displays a count indicating how many seconds the deployment cycle lasts. The energy weapon will count up from the number 1 up to 99. At 99 seconds, the count will restart at one.



ARC switch

If you press the ARC switch, the CID will display the deployment cycle duration with the operating mode icon. The energy weapon will count up. In the CID shown below, the Warning Arc display has been in effect for three seconds. The Semi-Automatic mode icon displays, and the battery is 81–100 percent full.



Top LASER

The top LASER installed in the X2 energy weapon is oriented with the mechanical sights. At 15 feet (4.6 m), the aiming point is aligned to the approximate trajectory of a 25-foot (7.6 m) cartridge's top probe.

Bottom LASER

At 15 feet (4.6 m), the bottom LASER is aligned to the approximate trajectory of a 25-foot (7.6 m) cartridge's bottom probe. The bottom LASER only appears when the selected bay contains a live cartridge or a resettable training cartridge.

The bottom LASER is not aligned to the trajectory of a 35-foot (10.7 m) cartridge.

The X2 energy weapon can be configured to disable the bottom LASER when a 35-foot cartridge is selected in the energy weapon. To change the 35-foot LASER settings, the agency must configure the energy weapon through Axon Evidence services.

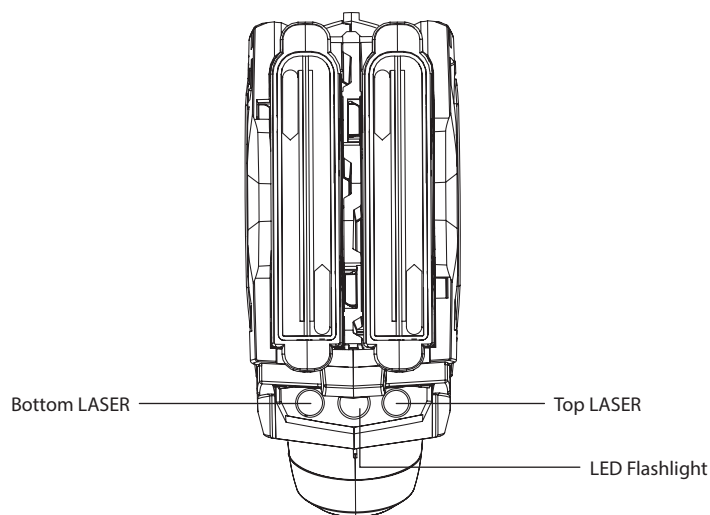

Mechanical Sights

The mechanical sights on the X2 energy weapon are molded to provide manual aiming of the energy weapon. The mechanical sights are set to coincide with a top probe's trajectory at a 15-foot distance.

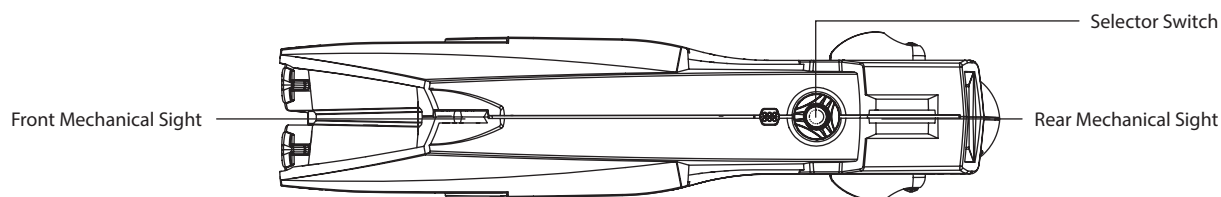

LED Flashlight

The X2 energy weapon has a high intensity white LED to aid the user in dark environments.



Selector Switch

With the safety in the down (SAFE) position, press the selector switch on the top of the X2 energy weapon to configure the system. See *Configuring the X2 Energy Weapon and Viewing the System Status* for more information.

The selector switch is slightly recessed to ensure that it is not pressed unintentionally during normal operations.

Pressing the selector switch when the safety is in the up (ARMED) position puts the X2 energy weapon in stealth mode—the flashlight and LASER are turned off and the CID will dim. Pressing and releasing the switch a second time will restore the energy weapon's configured illumination settings.

Notes:

- The stealth mode cannot activate features that were turned off during energy weapon configuration. If the X2 energy weapon is configured to not use its flashlight or LASERS, the stealth mode will not turn them on.
- Using pens or paper clips to attempt to press the selector switch may damage it. Only use your finger to press the selector switch.

Trigger Switch

Unlike a firearm trigger, the X2 energy weapon trigger switch is a momentary electrical switch. The trigger is operational only when the safety is in the up (ARMED) position. Pulling and releasing the trigger switch will deploy the first selected active cartridge and result in an approximately 5-second discharge cycle unless the safety is moved to the down (SAFE) position to discontinue the 5-second cycle. Pulling and holding the trigger switch for more than five seconds will result in a continuous discharge until the trigger switch is released, the safety is moved downward, or the battery is depleted—whichever happens first.

An X2 energy weapon equipped with the APPM battery pack is limited to 5-second discharges and emits an audio alert two seconds before the end of the cycle. See *Automatic Shut-Down Performance Power Magazine (APPM) Battery Pack* for more information. An X2 energy weapon equipped with an SPPM can be configured to enable the energy weapon's automatic shutdown feature. See *Signal Performance Power Magazine (SPPM) Battery Pack (Model T00074)* for more information.

In the event of an accidental discharge, immediately move the safety to the down (SAFE) position to stop the discharge cycle.

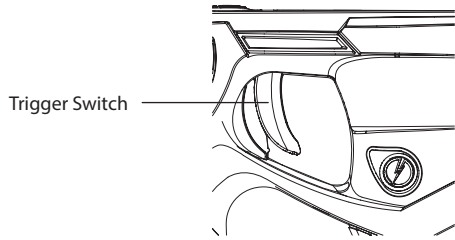

Semi-Automatic Mode

Depending on your agency's settings, your X2 energy weapon will function in either the Semi-Automatic or Manual firing mode. The X2 energy weapon is programmed in Semi-Automatic mode when it leaves the factory. If your energy weapon is configured to function in the Manual mode, see *Manual Mode*.

Sequential trigger pulls can deploy a Smart Cartridge. At the beginning of the event, the leftmost active cartridge is selected by default.

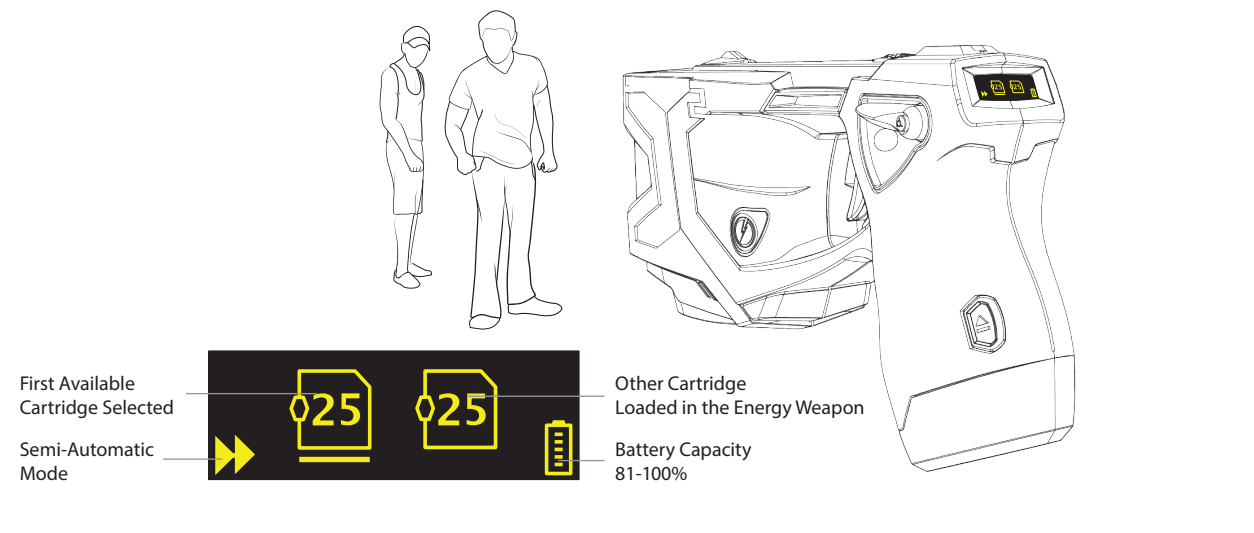

1 Pull the trigger to deploy the selected cartridge.

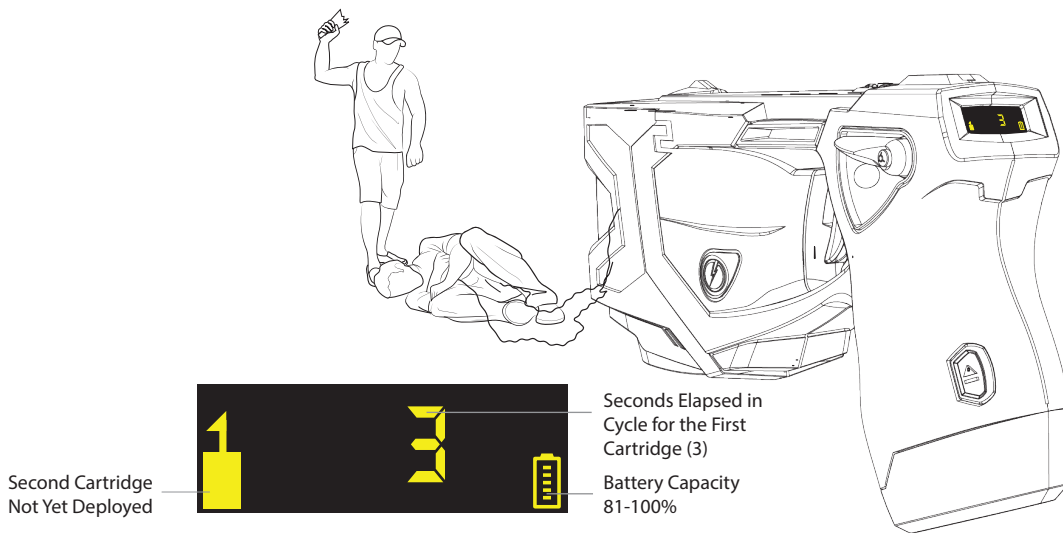
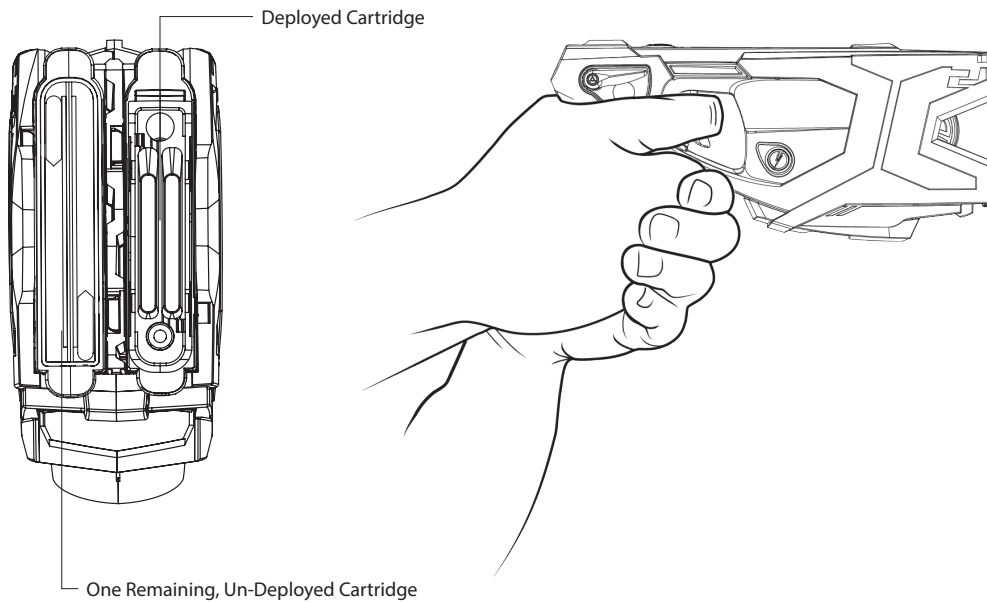

The X2 energy weapon energizes the first cartridge. Releasing the trigger automatically selects the next cartridge while the first cartridge is deploying.

If you have engaged a target and contact is good, pressing and holding the ARC switch will apply energy to both cartridge bays but will not deploy an unexpended cartridge. This allows you to apply cycles to a continually resisting subject, if needed, without expending the remaining cartridge.

2 Pull the trigger to deploy the second cartridge.

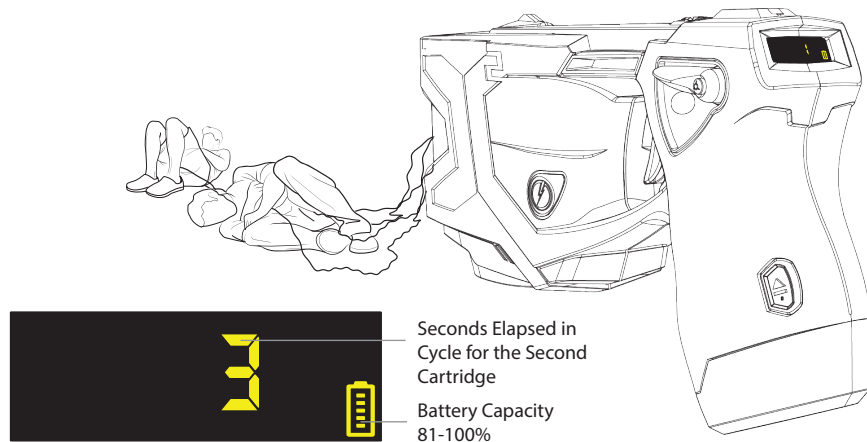
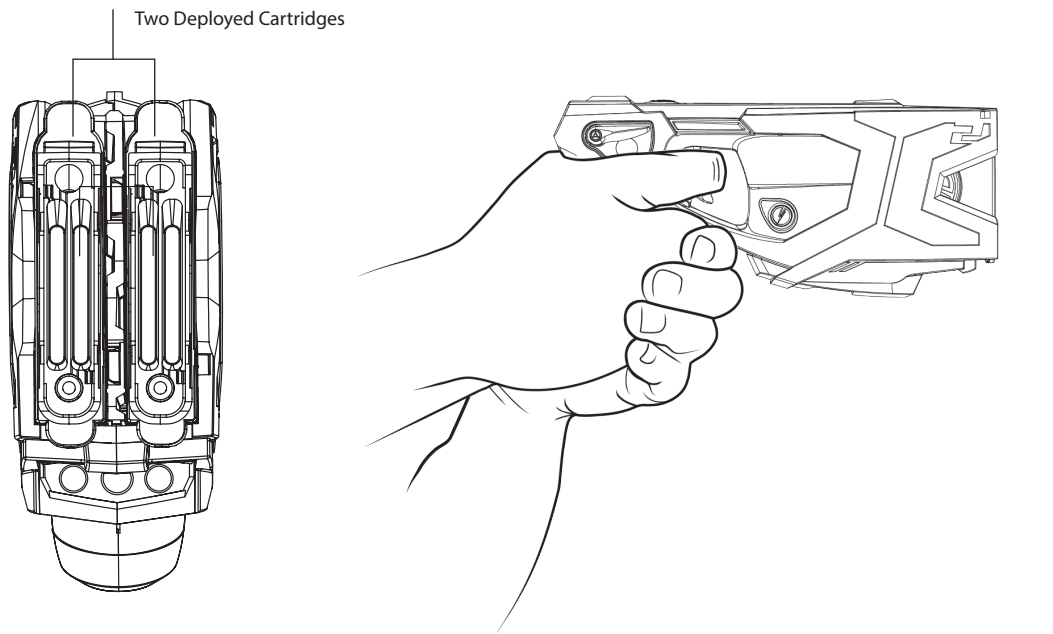

When both the first and second cartridges are energized each of the two firing bays will run for approximately five seconds on its own counter. If the second cartridge is deployed while the first cartridge is still energized, the first cartridge's cycle will end before the second cartridge's cycle ends. Therefore, to energize both cartridge bays, press the ARC switch. If the ARC switch is held down after the second cartridge's cycle ends, both cartridge bays will continue to cycle.

Note: If the probes from cartridge bay #1 are in subject A and the probes from cartridge bay #2 are in subject B, then pressing the ARC switch will energize both cartridge bays and both subject A and B will receive the effects of the energy weapon.

Moving the safety to the down (SAFE) position stops the cycle for all cartridge bays.

Note: Do not pull the trigger and press the ARC switch simultaneously. The trigger will override the ARC switch.

Manual Mode

Depending on your agency's settings, your X2 energy weapon will function in either the Semi-Automatic or Manual firing mode. If your energy weapon is configured to function in the Semi-Automatic mode, see *Semi-Automatic Mode*.

Note: The Semi-Automatic mode is the default method of operation. Manual mode can be configured only through Axon Evidence services.

Arc display/Re-energize/Cartridge advance (ARC) Switch Functions

The trigger and ARC switch work differently in the Manual mode than they do in the Semi-Automatic mode. In Manual mode, pulling the trigger does not advance cartridge selection. Instead, the ambidextrous ARC switch is used to select the Smart Cartridges. By default, the left cartridge (or the first available cartridge, from left to right) is selected automatically. (This is the left side from your perspective, while pointing the energy weapon.) Pulling the trigger deploys the left cartridge. Pressing and releasing (quickly tapping once) the ARC switch selects the next available cartridge. An additional trigger pull is required to deploy the next selected cartridge. When a live cartridge is still available, the energy weapon will not select a deployed cartridge.

A sustained press of the ARC switch for approximately $\frac{1}{2}$ second or more energizes the front of the cartridges without deploying (discharging) them. See *Warning Arc Display* (Chapter 4) for more information. If you have already deployed cartridges, pressing the ARC switch and holding it down supplies energy to the deployed cartridges without deploying any un-discharged cartridges.

If you have engaged a target with the first cartridge and contact is good, you can apply additional cycles to a continually resisting subject, if needed, without deploying the remaining cartridge. Holding the ARC switch down continually will arc the energy weapon until the ARC switch is released or the PPM is depleted, whichever happens first.

Because the ARC switch is ambidextrous, you can press from either side as you hold the energy weapon in a 2-handed grip.

Trigger Functions

In Manual mode, after the first cartridge is deployed, pulling the trigger again will apply additional energy through the wires to the probes. Unlike with the Semi-Automatic mode, this will not deploy additional cartridges. It is recommended to always press and hold the ARC switch when you need to re-energize a deployed cartridge without expending the additional cartridge (in both Manual and Semi-Automatic mode).

After deploying a cartridge, you can press and release (quickly tap once) the ARC switch to select another cartridge to use. You do not have to wait for the cycle of the first cartridge to end before deploying a new cartridge.

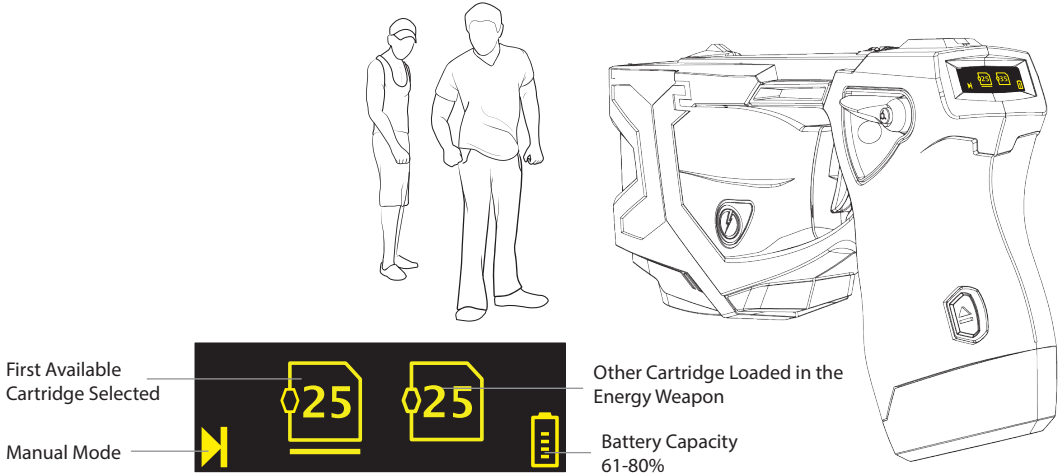

1 Pull the trigger switch to deploy the first cartridge.

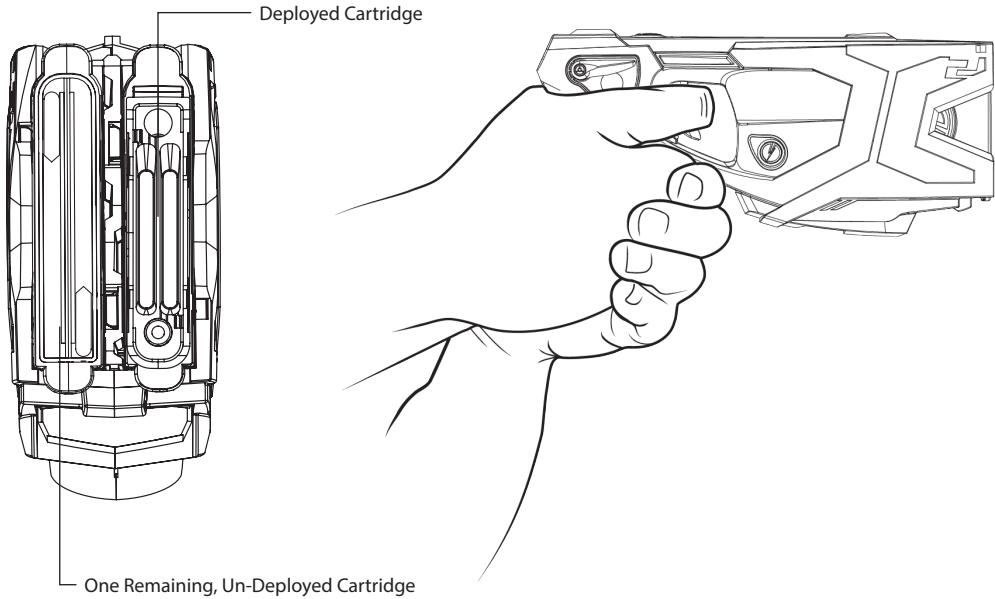

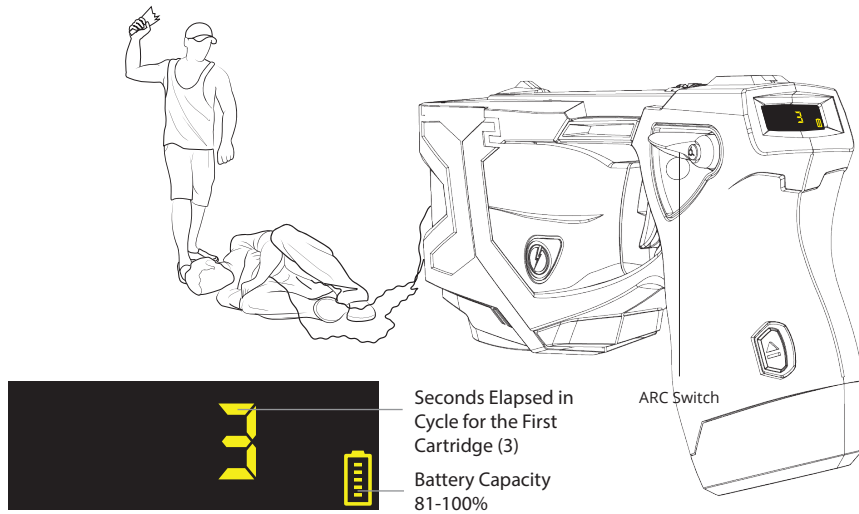

The X2 energy weapon energizes the first cartridge.

- 2 Quickly press (tap once) the ARC switch to select the second cartridge.

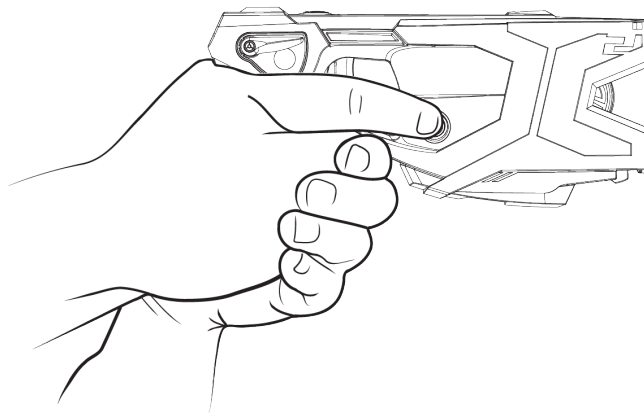

3 Pull the trigger to deploy the second cartridge.

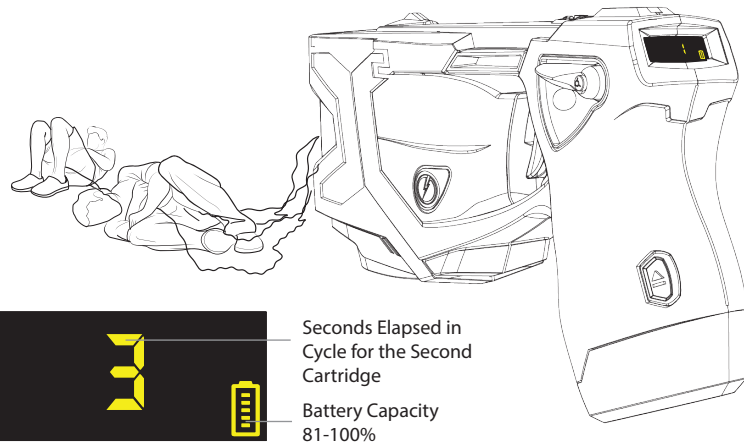
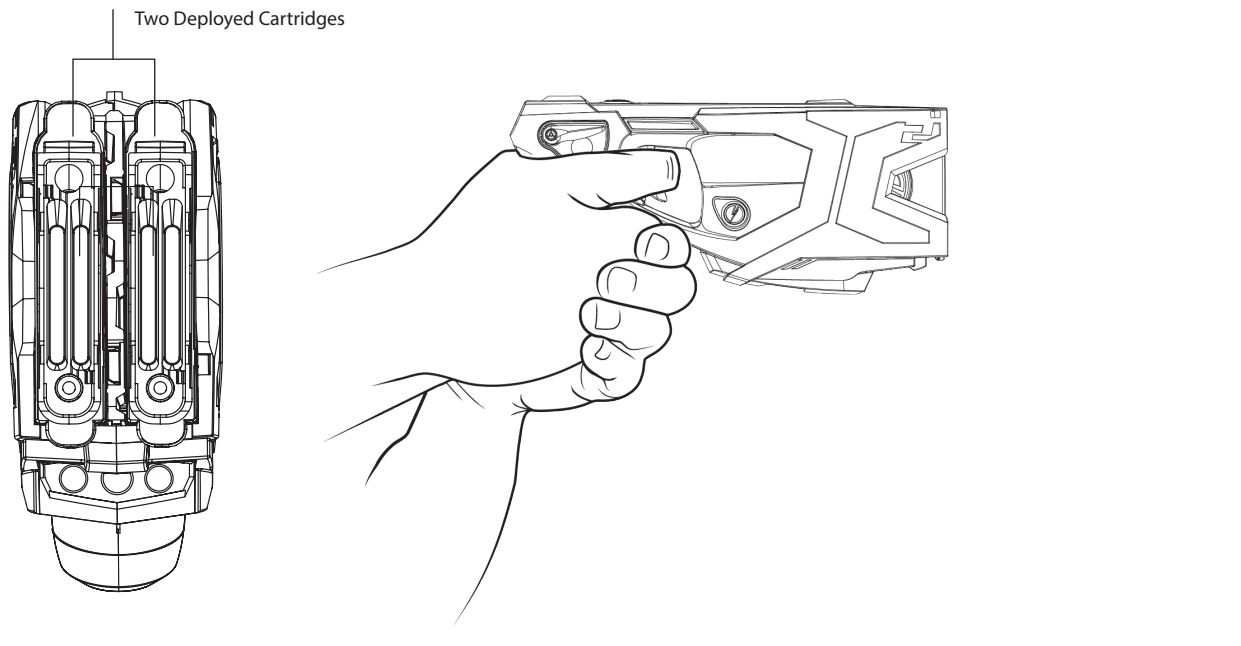

Because both the first and second cartridges are energized each of the two firing bays will run for approximately five seconds on its own counter. If the second cartridge is deployed while the first cartridge is still energized, the first cartridge's cycle will end before the second cartridge's cycle ends. Therefore, to energize both cartridge bays, press the ARC switch. If the ARC switch is held down after the second cartridge's cycle ends, both cartridge bays will continue to cycle.

Note: If the probes from cartridge bay #1 are in subject A and the probes from cartridge bay #2 are in subject B, then pressing the ARC switch will energize both cartridge bays and both subject A and B will receive the effects of the energy weapon.

Moving the safety to the down (SAFE) position stops the cycle for all cartridge bays.

Note: Do not pull the trigger and press the ARC switch simultaneously. The trigger will override the ARC switch.

Configuring the X2 Energy Weapon and Viewing the System Status

Remove the Smart Cartridges from the X2 energy weapon before configuring the energy weapon or viewing its status. See *Unloading* (Chapter 4) for more information.

Before using an X2 energy weapon, set the LASER settings and LED flashlight (if necessary). You also can view status information about your energy weapon on the CID.

Setting the Sighting Options

You can set up your X2 energy weapon to turn the LED flashlight and LASER sights off or on, in several configurations.

Follow these steps:

- 1 Point the X2 energy weapon in a safe direction.
- 2 Move the safety to the down (SAFE) position.
- 3 Remove the Smart Cartridges from the X2 energy weapon. See *Unloading* (Chapter 4) for more information.
- 4 Press and hold the selector switch until the MAIN MENU displays.

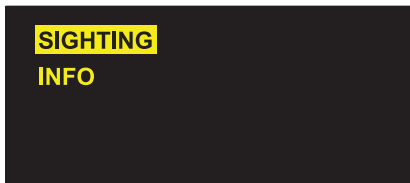

- 5 Press the left ARC switch to open the sighting options.
- 6 Press the right ARC switch to select the needed setting.



OO – LASER and flashlight OFF
 LO – LASER ON and flashlight OFF
 OF – LASER OFF and flashlight ON
 LF – LASER and flashlight ON

- 7 Press the selector switch or the left ARC switch to return to the MAIN MENU.
- 8 If you are done configuring the X2 energy weapon, press the selector switch again to exit. Or, to set other options, use the right ARC switch to scroll through the menus.

Viewing the System Information

To view information about the X2 energy weapon system (for example, the serial number, date, time, and firmware revision level), follow these steps:

- 1 Point the X2 energy weapon in a safe direction.
- 2 Move the safety to the down (SAFE) position.
- 3 Remove the Smart Cartridges from the X2 energy weapon. See *Unloading* (Chapter 4) for more information.
- 4 Press and hold the selector switch until the MAIN MENU displays.

- 5 Press the right ARC switch until the INFO option is selected.



- 6 Press the left ARC switch. The SYSTEM option should be highlighted by default.



- 7 Press the left ARC switch. From top to bottom the CID displays the X2 energy weapon's serial number, date, time (GMT), and firmware revision number.

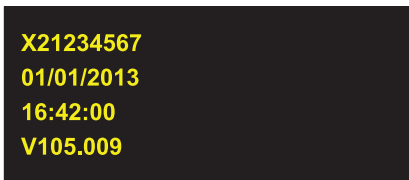

- 8 Press the selector switch to return to the INFO MENU.
- 9 If you are done viewing the system information, press the selector switch again to go to the MAIN MENU. Or, to view other information, use the right ARC switch to scroll through the menus.

Viewing the Battery Pack Information

To view information about the battery pack, follow these steps:

- 1 Point the X2 energy weapon in a safe direction.
- 2 Move the safety to the down (SAFE) position.
- 3 Remove the Smart Cartridges from the X2 energy weapon. See *Unloading* (Chapter 4) for more information.
- 4 Press and hold the selector switch until the MAIN MENU displays.
- 5 Press the right ARC switch until the INFO option is highlighted.



- 6 Press the left ARC switch.
- 7 Press the right ARC switch until the PPM option is highlighted.

Note: If you have a TPPM installed, the system will still indicate the battery pack is a PPM.

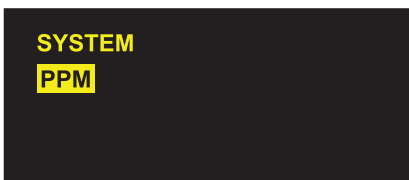

- 8 Press the left ARC switch. From top to bottom, the CID displays the battery pack serial number, approximate battery voltage, battery capacity remaining, and type of battery pack.

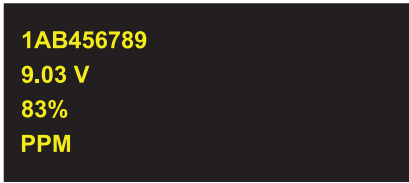

- 9 Press the selector switch to return to the INFO MENU.
- 10 If you are done viewing the battery information, press the selector switch again to go to the MAIN MENU. Or, to view other information, use the right ARC switch to scroll through the menus.

Enabling SPPM Signal Mute Mode

- 1 With the safety in the down (SAFE) position, press and hold the selector switch until the MAIN MENU displays.

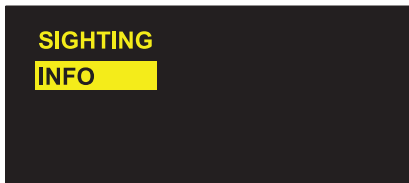

- 2 Press and release the selector switch and SPPM MUTE will be displayed on the CID.

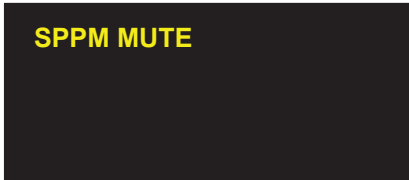

- 3 If the safety is placed in the up (ARMED) position while this screen is displayed, the energy weapon will enter Mute Mode for the session. In Signal Mute Mode, an inverted SPPM icon will be displayed in the upper left corner of CID. See *Signal Mute Mode* for more information. The device will return to normal operation after the safety is placed in the down (SAFE) position. Any pending 30-second transmissions will be discontinued. See *Continued SPPM Transmit in Safe Option* for more information.

Chapter 4: Cartridges and Energy Weapon Operation

Remove the Shipping Cover from the Smart Cartridge

Smart Cartridges (sold separately) are shipped with a shipping cover in place. Carefully remove the cover before attempting to load a cartridge into an X2 energy weapon.

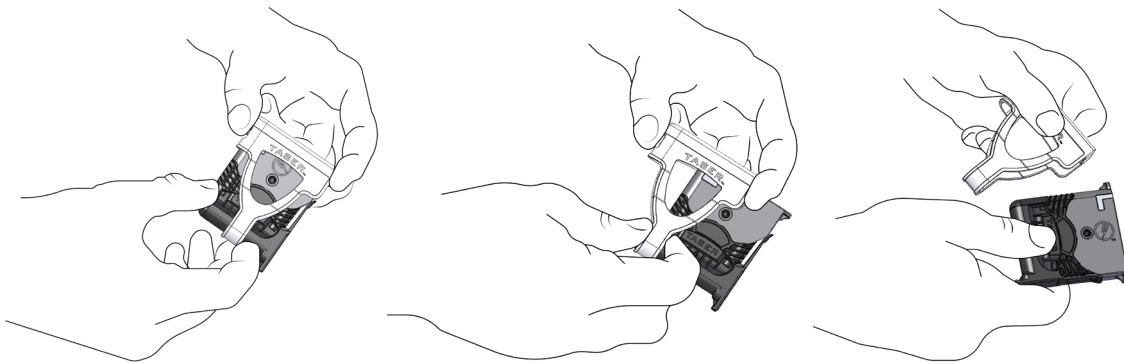

- 1 Hold the cartridge over a table or other close by surface so the cartridge will not fall to the floor if it is dropped.
- 2 Hold the cartridge so the blast doors are facing away from you and others.
- 3 Find the cartridge tab sticking out the rounded side of the shipping cover.

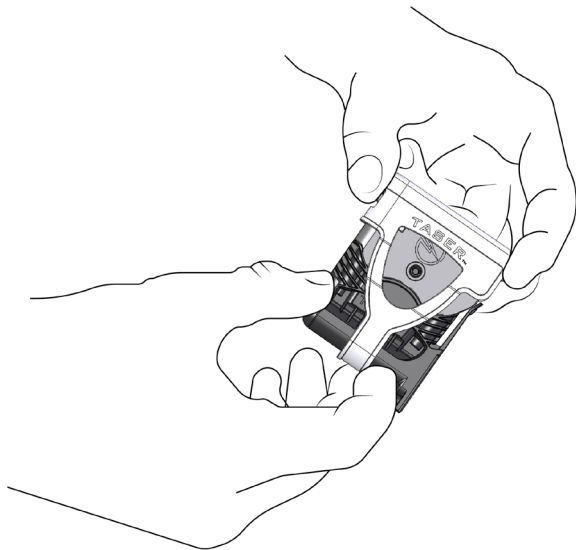

- 4 Push against this tab while pulling the cartridge out. You might consider pushing on the cartridge with your thumbs and holding the cover with your fingers. There should be an audible click when the cover releases the cartridge.

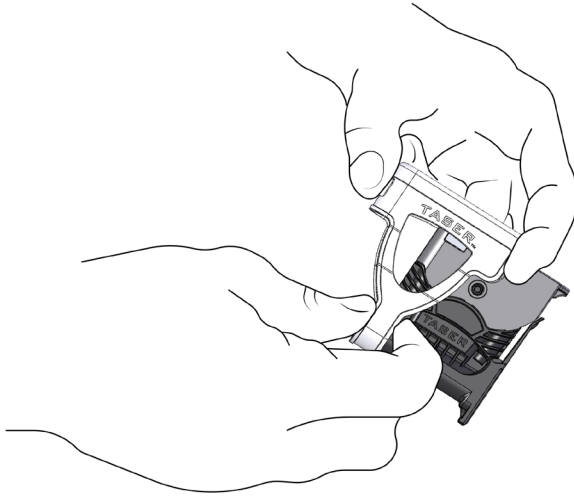

- 5 Pull the cartridge out of the cover.

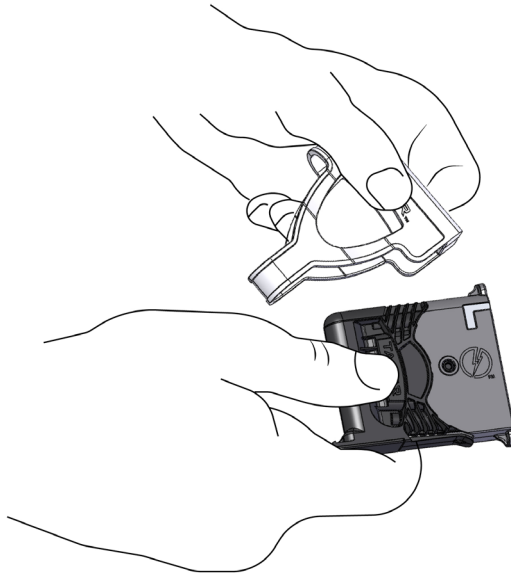

X2 Smart Cartridge Characteristics

The X2 energy weapon is designed to work with Smart Cartridges manufactured by Axon Enterprise, Inc. Do not use cartridges made by other companies with an X2 energy weapon. Smart Cartridges are distinguished by range and purpose:

- Live cartridges are designed for self-defense and public safety.
- Simulation cartridges are designed for use with training suits that protect the wearer from probe impact.
- Inert resettable simulator cartridges are designed for function tests and training scenarios that require pulling the trigger without deploying cartridges.

Standard-Range (15-foot/4.6-meter and 25-foot/7.6-meter) Smart Cartridges

A 15-foot cartridge is identified by yellow blast doors. A 25-foot cartridge has black blast doors.

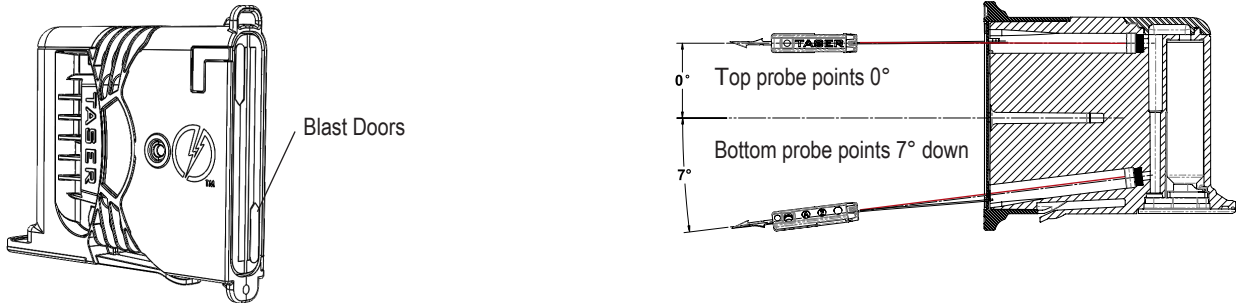

Long-Range (35-foot/10.7-meter) Smart Cartridges

A 35-foot cartridge identified by a raised arch on the side used to be offered. The 35-foot cartridges for the X2 were discontinued in 2017. Thus, any still in existence are expired and should be removed from service.

Simulation Smart Cartridges

Simulation Smart Cartridges use specialized probes for use with a person wearing training suit in role-playing training scenarios. There are two types of simulation Smart Cartridges, designed for two types of training suits.

A Smart Cartridge with blue blast doors has probes designed for use with the TASER Simulation Suit. These probes have shortened darts to minimize the likelihood of penetrating the suit.

A Smart Cartridge with purple blast doors has probes designed for use with the Hook and Loop Training (HALT) Suit. These probes use hook and loop fastener technology to stick to the suit.

Do not use Smart Cartridges with blue blast doors against a person wearing the HALT suit.

Inert Resettable Simulator Cartridges

Inert resettable simulator Smart Cartridges are identifiable by their red or clear blast doors. They do not contain probes and do not deploy when the trigger is pulled. After the trigger is pulled, the CID displays a deployed cartridge icon. If you move the safety to the down (SAFE) position and then the up (ARMED) position, the CID displays an un-deployed training cartridge icon again. It may take 30 seconds for the device to reset and display an un-deployed cartridge.

When an inert resettable simulator Smart Cartridge with red blast doors is loaded in an X2 energy weapon, the CID displays a training cartridge icon for the cartridge bay in which this type of cartridge is loaded. When an inert resettable simulator Smart Cartridge with clear blast doors is loaded in an X2 energy weapon, the CID displays a standard cartridge icon for the cartridge bay in which this type of cartridge is loaded.

Inert resettable simulator cartridges are intended for training scenarios that do not require probe deployment, and conducting trigger function tests. See *Trigger-Initiated Function Test* (Chapter 5) for more information.

Smart Cartridges General Instructions

Never attempt to open or modify a Smart Cartridge. Tampering with a Smart Cartridge could cause it to fire or malfunction (which may result in serious injury).

Remove the Smart Cartridge from the X2 energy weapon before inspection.

Before installing and using a Smart Cartridge, inspect the blast doors for cracks. The inspection should

include checking the break seam running down the center and both sides of the front of the blast door. If the blast doors are cracked, remove the Smart Cartridge from service.

Also, inspect the Arc deflector metalized labels. Over time, the labels may show signs of wear. This is normal. If the labels have worn away completely or fallen off, remove the Smart Cartridge from service.

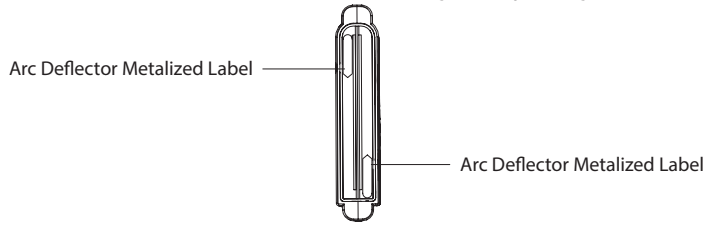

The X2 energy weapon can determine whether the Smart Cartridges loaded in the cartridge bays have been expended or not. The energy weapon also can determine whether all the cartridge bays are loaded or not. This means the energy weapon will not select an empty bay or an expended cartridge when a live cartridge is available. Cartridge status is displayed on the CID.



AFID

Every time a Smart Cartridge is deployed, approximately 20–30 small confetti-like Anti-Felon Identification (AFID) tags are ejected. Cartridges can be assigned to individual users, as each is serialized. Each AFID tag is printed with the corresponding serial number of the cartridge, allowing determination of which user deployed the particular cartridge.

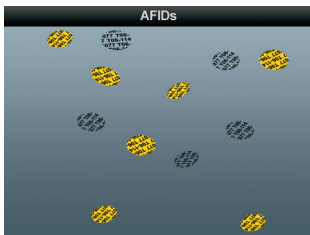

Load the Smart Cartridges

Never place your hands, fingers or other body part in front of the cartridge. This is especially important when loading and unloading the cartridge. Serious injury could result. When loading and unloading always hold the cartridge on the sides or top.

Smart Cartridges are shipped with a shipping cover in place. Remove these covers before attempting to load a cartridge into an X2 energy weapon. See *Remove the Shipping Cover from the Smart Cartridge* for more information.

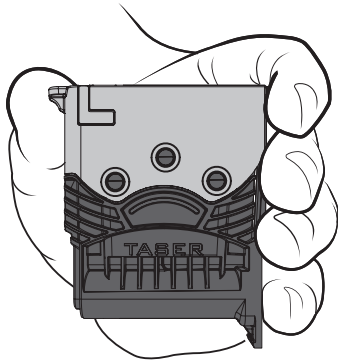

Always treat your X2 energy weapon as if it were loaded. Also, be aware that it is more difficult to tell whether an X2 energy weapon is loaded than it is with previous-generation TASER energy weapons.

Unloaded X2 energy weapon viewed at an angle:

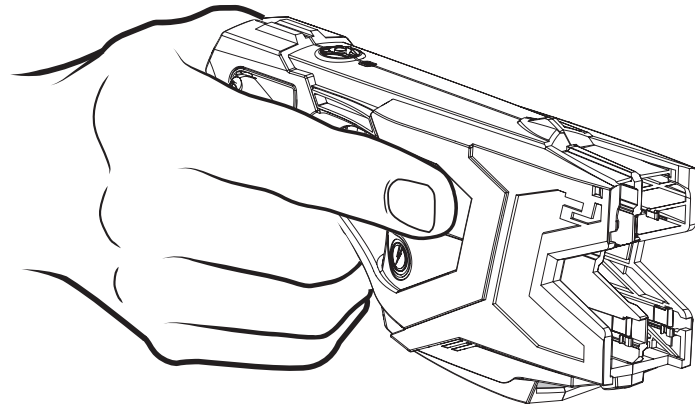

Loaded X2 energy weapon viewed at an angle:

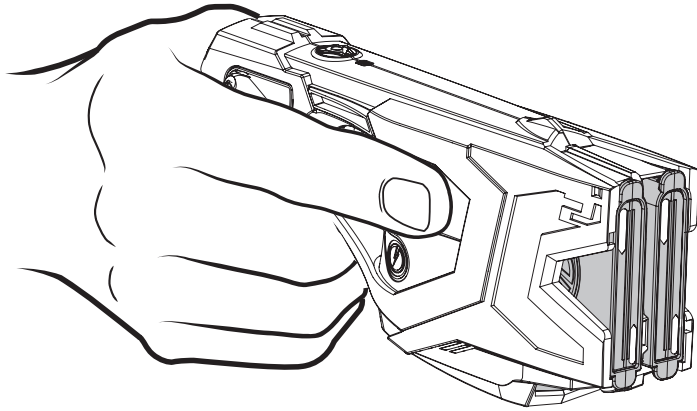

- 1 Point the energy weapon in a safe direction.
- 2 Ensure the safety is in the down (SAFE) position and your finger is not on the trigger or ARC switch.
- 3 Ensure the protective shipping cover is removed from the Smart Cartridge.
- 4 Keeping your hand away from the blast doors, gently push the Smart Cartridge into the cartridge bay until an audible click is heard.

Note the position of the tab on the bottom of the cartridge; this side of the cartridge goes in the bottom of the X2 cartridge bay.

- 5 Verify that the cartridge is secure by pulling on the tabs on the lower and upper part of the cartridge.

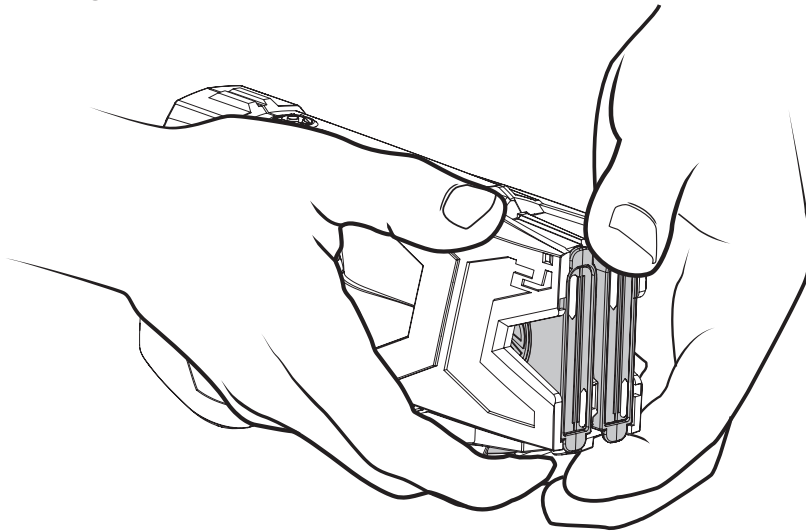

- 6 By loading from the right cartridge bay to the left bay (or left to right if the right hand is used), it is less likely the operator will place fingers in front of the blast doors of loaded cartridges.

Cartridge Release Button

Smart Cartridges are held in the X2 energy weapon after they are loaded. Press the cartridge release button to release the cartridges before attempting to remove them from the energy weapon. For further instructions, see *Unloading*.

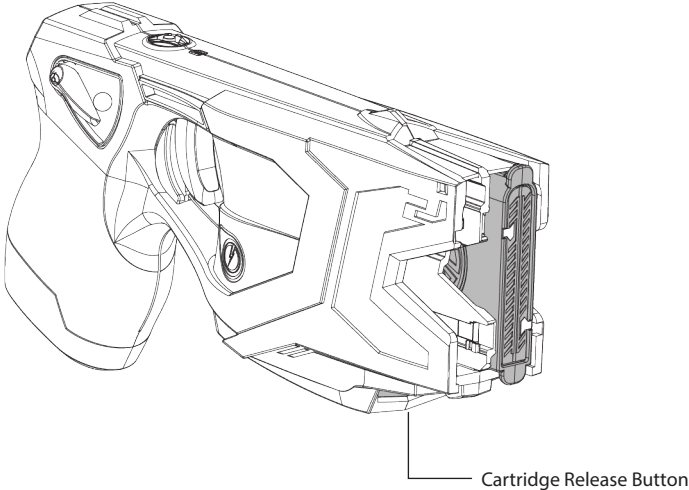

Unloading

- 1 Point the energy weapon in a safe direction.
- 2 Ensure the safety is in the down (SAFE) position.
- 3 Keep your hands away from the front of the cartridges.
- 4 Press the cartridge release button with the index finger of your supporting hand.
- 5 Firmly pull the cartridge out of the bay by pulling on the upper tab and lower tab of the cartridge. If the expended cartridge feels as if it is stuck in the cartridge bay and will not easily dislodge, try firmly pressing on the cartridge release button directly below the individual cartridge that is difficult to remove.

Note: Use the left hand to unload cartridges beginning with the leftmost cartridge bay. By unloading from left to right (or right to left if the right hand is used), it is less likely you will place fingers in front of the blast doors of loaded cartridges.

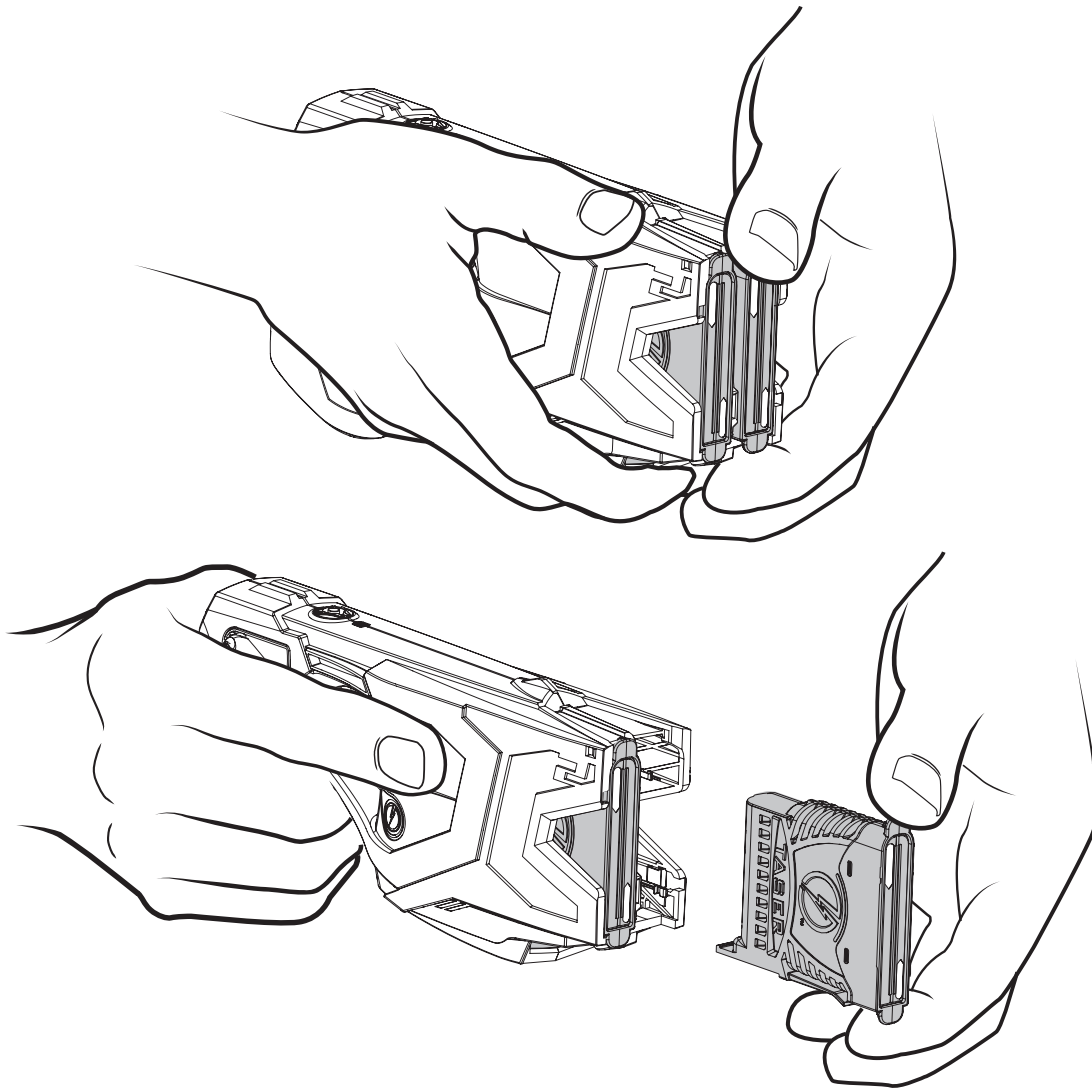

The Smart Cartridges can be reloaded independently. That is, if one of the two cartridges has been expended, you can replace the expended cartridge with a new one. You do not have to wait until both cartridges have been expended before reloading.

To replace the expended cartridge:

- 1 Point the energy weapon in a safe direction.
- 2 Ensure the safety is in the down (SAFE) position.
- 3 Press the cartridge release button.
- 4 Firmly pull the cartridge out of the bay by pulling on the upper tab and lower tab of the cartridge.
- 5 Keeping your hand away from the blast doors, gently push a new Smart Cartridge into the cartridge bay until an audible click is heard.
- 6 Verify that the cartridge is secure by pulling on the tabs on the lower and upper part of the cartridge.
- 7 Verify that the remaining Smart Cartridge is secure by pulling on the tabs on the lower and

upper parts of the cartridge.

Selecting Cartridges

By default, the leftmost (when the front of the energy weapon is facing away from the user) live cartridge is selected. You can use the ARC switch to designate which cartridge you want to use. This feature is used to select cartridges when the energy weapon is in *Manual Mode* (Chapter 3).



Pressing and releasing the ARC switch quickly selects the second cartridge.



Aiming and Probe Placement

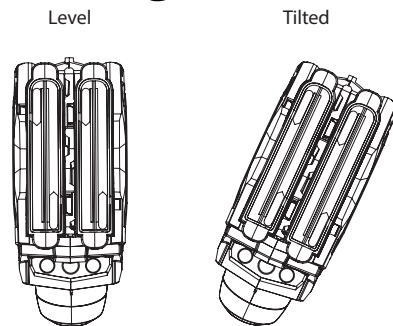

For most deployments, hold the energy weapon level. Tilt the energy weapon when necessary to align the probes with the target.

All TASER energy weapon deployments should be in accordance with current TASER training and warnings, and department training, policies, and procedures.

When possible, aim the LASER at the preferred target areas of the body, which are the lower torso and legs when the subject is facing you, or the subject's back if the subject is turned away from you.

When possible, avoid intentionally targeting the energy weapon on sensitive areas of the body such as the head, eyes, throat, chest/breast, groin, or known pre-existing injury areas without legal justification.

The top probe is designed to impact the target near the top LASER beam but exact placement can vary depending on numerous factors, including, but not limited to the distance, type of cartridge, and environmental factors.

If both the upper and lower LASERs are active, you should be able to estimate where each probe will hit.

Note: The LASERs are designed to coincide with the top and bottom probes of a 15- or 25-foot (4.6 m or 7.6 m) Smart Cartridge at 15 feet. Thus, if your target is 15 feet away, and your energy weapon is loaded with a 25-foot Smart Cartridge, the probes will strike the target approximately where the LASERs are projected. If the energy weapon is being held perfectly vertical, the top and bottom LASERs should be vertically aligned. If you are significantly closer or further than 15 feet to the target, the LASERs will appear to be out of alignment. This is because the two LASERs are located almost one inch apart side-by-side on the energy weapon and zeroed to 15 feet.

If a single cartridge is deployed and an electrical circuit is completed and maintained, the energy weapon will be relatively quiet. Multiple cartridge deployments and Warning Arc displays are likely to make more noise.

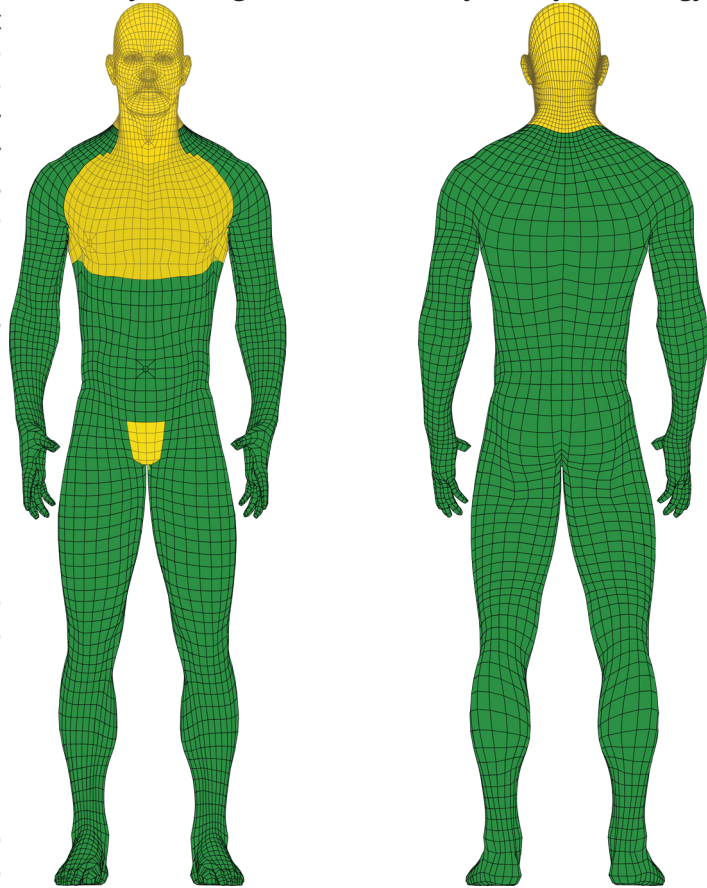

Audible Pulse Rate Changes

The energy weapon normally arcs at an average rate of 19 pulses per second (PPS). To improve the service life of the energy weapon and battery life, firmware version 4.029 allows the PPS rate to drop to approximately 9 PPS when there is no connection (e.g., a single probe hit, clothing disconnect, etc.). Thus, firing probes into a non-conductive target will likely cause this PPS reduction to occur. Upon detecting a closed circuit, the PPS will immediately return to 19 PPS. This change in PPS does not affect daily functionality checks, drive-stuns, or effective probe deployments.

Potential Causes of Reduced or No Effectiveness

- **Loose or thick clothing.** If the probes lodge in clothing and are too far away from the subject, energy weapon effectiveness may be reduced.
- **Miss or single probe hit.** The electrical current must pass between a positive probe and a negative one (top and bottom probe). If one probe misses, the energy weapons will not be effective.
- **Low nerve or muscle mass.** If the probes impact in an area where there is very little muscle mass (e.g., the side of the rib cage), the effectiveness may be reduced.
- **Limited probe spread.** Probe spreads of less than 12 inches/30 cm (including drive-stun) may result

in reduced energy weapon effectiveness.

- **Wires Break.** If a wire breaks (e.g., during a struggle), the current will not flow to the probes and the energy weapon will not be effective.

In any of the above scenarios, a second cartridge may be deployed or a drive-stun follow up may be used if practical, justified, and within your agency's policy.

Do not become over-dependent on the TASER energy weapon. No force option, including energy weapons, is 100% effective in every situation. Do not deploy the energy weapon without following your department policies and procedures.

Warning Arc Display

With the safety in the up (ARMED) position, pressing and holding the ARC switch displays a Warning Arc discharge across the front of the X2 energy weapon.

With a Warning Arc display, the user may deter a subject without having to use actual force. Unlike with the M26, X26, and X26P energy weapons, a Warning Arc can be accomplished without removing the live cartridges. Pressing the ARC switch does not deploy the Smart Cartridges even if the X2 energy weapon is loaded.



Note: Pressing the ARC switch for a half-second or less will advance cartridge selection to the right. A sustained ARC switch press (greater than half a second) will not advance the cartridge selection.

Use the ARC switch, not the trigger switch, to employ the Warning Arc display. Pulling the trigger switch will deploy a loaded cartridge.

Electrodes

The front of the X2 energy weapon has four metal electrodes. The electrodes provide the ability to use the X2 energy weapon in a “drive-stun” mode as a traditional stun gun-type energy weapon.

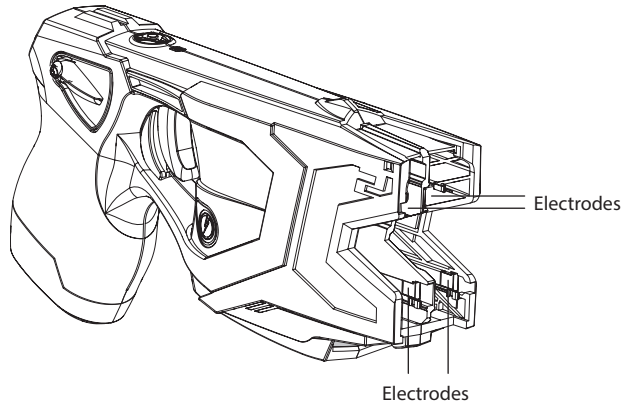

Drive-Stun Backup

Drive-stun capability is available with the X2 energy weapon. To apply a drive-stun, place the safety in the up (ARMED) position and press the ARC switch, just as you would to employ a Warning Arc display.

When you use the ARC switch, energy will spark across all the electrodes or arc deflector metalized labels without deploying the cartridges.

When using the drive-stun, push (drive) the front of the energy weapon firmly against the body of the subject. Simply “touching” the energy weapon against the subject is not sufficient. The subject is likely to recoil and try to get away from the energy weapon. It is necessary to aggressively drive the front of the energy weapon into the subject for maximum effect.

Drive-stun mode is not designed to cause incapacitation and primarily becomes a pain compliance option. Drive-stun is only effective while the energy weapon’s electrodes are in direct contact with the subject or when pushed against the subject’s clothing. As soon as the energy weapon is moved away, the energy being delivered to the subject stops.

If the probes are deployed, even at very close range, the user may drive-stun to another portion of the body that is further away from the probes, thereby increasing the possibility of inducing incapacitation.

Recommended Drive-Stun Areas for Maximum Effect

Use the energy weapon pursuant to your agency's policies and procedures. For maximum effectiveness, drive the X2 energy weapon into the highlighted green areas as outlined below:

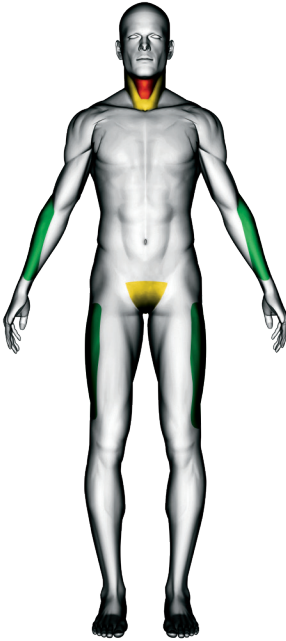

Suggested pressure points are highlighted in the green areas. Use care when applying the drive stun to the neck or groin (yellow areas – users should only target these areas when they are defending themselves against a violent attacker). Stay away from the trachea and back of the neck. The trachea is soft tissue and could easily be crushed. The cervical portion of the spine is very sensitive to pressure. Also, care should be taken when applying a drive stun to the pelvic triangle to avoid the possibility of crushing the testicles.

Refer and adhere to your department's policy and training regarding drive-stuns in these and other sensitive areas.

Chapter 5: Maintenance/Troubleshooting

ARC Switch-Initiated Function test

Axon Enterprise recommends conducting a function test prior to the start of your shift. The function test is done to verify that the energy weapon's core electronics are working properly. To test the trigger, see *Trigger-Initiated Function Test*.

An X2 energy weapon can be function tested with the cartridges loaded. In fact, it is recommended you perform the test with cartridges installed to reduce stress on the energy weapon's components.

To perform a function test:

- 1 Point the energy weapon in a safe direction.
- 2 Place the top rail of the X2 energy weapon in the palm of your secondary hand so you can grip the top rail and your thumb can reach the ARC switch, while the remainder of your secondary hand and fingers are away from the front of the energy weapon.
- 3 Move the safety to the up (ARMED) position. Keep all fingers away from the trigger and keep the energy weapon pointed in a safe direction. While performing a spark test, DO NOT touch the trigger at any time.
- 4 Press and hold the ARC switch for five seconds. Verify the arc rides across the face of all loaded cartridges between the arc deflector metalized labels.

Use the ARC switch, not the trigger, to perform a spark test. Pulling the trigger switch will deploy a loaded, unfired cartridge.

View the arc from the top or side of the energy weapon. Do not point the energy weapon at your face or have it near your face.

Look at the CID display and verify the following:

- No critical or major fault icons display on the upper-right corner of the CID.
- The cartridge information matches the cartridges inserted in the X2 firing bays.
- LO BATT is not displaying on the CID.

If any of the above verifications fail, return the unit to your agency's energy weapon technician for service.

- 5 Move the safety to the down (SAFE) position.

Trigger-Initiated Function Test

The function test above only checks the functionality of the core electronics. It does not check the functionality of the trigger or the energy weapon's ability to deploy cartridges. If you wish to perform a trigger function test, this procedure is recommended:

Note: Use inert resettable simulator cartridges, which have clear or red blast doors, for this test. Inert resettable simulator cartridges do not have probes.

Do not use live Smart Cartridges (that have black blast doors), or training simulator cartridges (that have blue or purple blast doors) for this test.

- 1 Ensure the safety is in the down (SAFE) position.
- 2 Ensure the energy weapon is loaded with inert resettable simulator cartridges. As necessary, see *Unloading or Load the Smart Cartridges* (Chapter 4) for more information.
- 3 Point the X2 energy weapon in a safe direction that allows you to see the arc in the cartridge bays. Do not point the energy weapon at your face or have it near your face.
- 4 Move the safety to the up (ARMED) position.
- 5 Pull the trigger.
- 6 Allow the X2 energy weapon to complete the 5-second discharge duration and visually confirm the arc across the cartridge in bay #1.

View the arc from the top or side of the energy weapon. Do not point the energy weapon at your face or have it near your face.

- 7 Pull the trigger.
- 8 Allow the X2 energy weapon to complete the 5-second discharge duration and visually confirm the arc across the cartridge in bay #2.
- 9 Confirm that the CID shows the cartridges as being deployed and that no errors have occurred during the simulated firings.
- 10 Move the safety to the down (SAFE) position.
- 11 Unload the inert resettable simulator cartridges.
- 12 Reload live cartridges if appropriate to do so.

What to Do Following Energy Weapon Use

Considerations for Handling Used Probes



Biohazard

Each agency will establish its own procedure for probe removal, collection, biohazards, evidence collection and maintenance. Treat probes that have penetrated the body as contaminated needles

(biohazard). Remember, however, that the probes may also be valuable evidence.

If the probes must be removed from the subject, follow all department policies and procedures, including for handling biohazards.

Below are suggested methods for probe removal.

- Grab the probe firmly and quickly pull it straight out. Do not twist the probe as the barbed tip may cause additional injury.
- If the probes are not going to be collected and maintained for evidence, carefully place used probes sharp-tip first into a sharps container, secure in place, and place in a secure location where no one will accidentally touch the probes.
- Once the subject is restrained, prior to removing the probes, evaluate the need for medical attention as you would with any other use-of-force incident.*
- Take photos of any injuries, place the photos into evidence.*
- Collect the expended cartridge, probes, and AFIDs and place them into evidence.*

* As directed by department policy. The TASER training materials provide additional information on forensic evidence collection procedures. The probes, wires AFIDs, and cartridge can yield important forensic evidence if properly collected, maintained, and analyzed.

Effects on Animals

TASER energy weapons can be an effective option for dealing with aggressive animals and have generally been successful in deployments.

Note: If a probe deployment completed circuit is initiated and maintained, the aggressive animals are usually incapacitated/stunned momentarily in deployments, but recover quickly. Typically, the animals left the scene and broke the wires.

If deployed on a domestic animal, consider having animal control available to restrain the animal.

Police/Military K-9 Caution

Energy weapon operators and K-9 officers must work closely together to develop policies and procedures for deploying the energy weapon when a K-9 is present. If a K-9 bites a probe or the wires or bites the suspect between the probes, or touches the cartridge wires, the K-9 could receive a shock. This could have a significant negative impact on the future duty use of the K-9.

Downloading Firmware Revisions

The X2 energy weapon internal firmware provides functionality for all aspects of the energy weapon. The firmware can be upgraded to the most recent version by using an X26P/X2 energy weapon Dataport Download Kit and Evidence Sync software (Online or Offline).

Do not remove the USB cable or press the reset button on the dataport USB pack during the reprogramming cycle.

Dataport Download Kit

Optional download kits are available to permit departments to access the encrypted deployment information in the X2 energy weapon memory through the Axon Evidence services or the Sync Offline or Online Client software.

Note: If you have a TASER CAM HD recorder, please see the *TASER CAM HD Operating Manual* and the *Evidence Sync User Manual* for downloading instructions.

The X2 energy weapon uses a USB adapter to connect to any Windows 7 or Windows 10 computer. The simplicity of USB makes using the dataport download kit an easy, fast process. The cable connects to the energy weapon through the battery compartment.

USB Connection Status

The USB icon will flash on the CID when the energy weapon is searching for the Evidence Sync client software. The icon will display solid when the energy weapon is connected to the software.



Evidence Sync Offline Software

If you do not have an Axon Evidence account, the Evidence Sync software can be used in the Offline mode to download the simplified Event log to your local computer and print it. The Evidence Sync Offline software will not enable you to view the full Trilogy log.

Evidence Sync Offline will *not* allow you to:

- Enable ARC switch override
- Enable hard stop
- Disable the SPPM automatic shut-down
- Set the operating mode (manual or semiautomatic)
- Enable or disable signal transmission in safe
- Set the LASER for 35-foot (10.7 m) cartridges
- Enable sharing of the engineering logs with Axon

Trilogy Log

The X2 energy weapon captures various pieces of information about the device – this is referred to as the Trilogy log:

- Event log
- Pulse log
- Engineering log

The data set from the Trilogy log is uploaded securely to Axon Evidence services, where the information is encrypted, stored securely, and organized into dashboards that allow your agency to easily monitor the usage and system status of your entire arsenal of X2 energy weapons.

Upon upload to Axon Evidence services, the system displays the information from the Event and Pulse logs. Your type of Axon Evidence account will determine what data can be viewed from these logs.

Event Log

The Event log tracks events and may help protect a user from claims of excessive force by providing

documentation of the time and date for each energy weapon deployment. The Event log also provides agencies with a powerful management tool to track usage patterns and help prevent misuse. You do not need to download the X2 energy weapon to Axon Evidence services to obtain the Event log – the simplified Event log can be downloaded directly to your PC using the Evidence Sync (Offline) software.

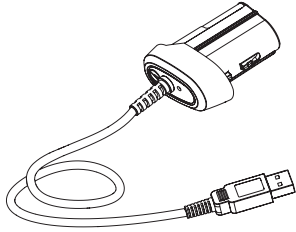

The Event log includes the following information for the most recent (approximately) 16,000 entries:

- Each entry contains the date and time of each event.
- Entries include Armed, Safe, Trigger, ARC, USB connection, PowerSave mode, firmware updates, time synchronizations, PPM changes, SPPM End of Transmission, agency setting changes, etc.
- The duration of each Trigger and ARC event.
- The duration of each Safe event (how long the energy weapon was armed when the safety was moved to the down [SAFE] position).
- The internal temperature is shown for Armed and Safe events.
- Battery percentage is shown for all armed session events (Armed, Trigger, ARC, Safe).
- Cartridge information is shown for all armed session events (Armed, Trigger, ARC, Safe).

When the log fills to approximately 16,000 entries, it will delete the oldest 4,096 records and write new ones. This process will continue in 4,096-record increments.

Pulse Log

The Pulse log records pulse activity of each pulse (e.g., probe deployments and Warning Arc displays). The Pulse log can help determine if the energy weapon's output was within specifications and determining if and when electricity was delivered to a subject.

Engineering Log

The Engineering log monitors the performance of every key sub-system within the X2 energy weapon and provides alerts to the user on the CID if any subsystem is not performing properly and if maintenance is advisable. Any internal circuitry errors that occur inside the X2 energy weapon are written to this log. This information is used for diagnostics.

Time Synchronization

The energy weapon has a real-time clock powered by the battery pack and an internal battery as well. The energy weapon should keep accurate time even when the battery pack is removed.

The X2 energy weapon is programmed to GMT at the factory. Every time the X2 energy weapon is connected to Axon Evidence services, the system will perform a time synchronization to GMT. The conversion to local time, including adjustments to daylight savings time, are all computed in the PC-based software. There is no need to program the X2 energy weapon to local time or to reprogram the energy weapon to daylight savings time.

If you do not have an Axon Evidence account, the energy weapon will synchronize with your local computer's time.

Note: In Evidence Sync Offline mode, if your computer time is incorrect, the incorrect time will be displayed in your Evidence Sync-generated report.

X2 Energy Weapon Maintenance and Care

Each agency should establish a maintenance and handling program.

The X2 energy weapon product is a sensitive piece of electronic equipment, and should be handled with care. Avoid dropping an X2 energy weapon. Do not use an X2 energy weapon that has cracks above the cartridge bays.

- Cracks may occur near where the battery is inserted and near the battery release button. Regardless of their location on the device, if the crack is over 0.3" (8 mm), do not use the energy weapon. Return the weapon to Axon if it is still under warranty.
- Check the battery pack regularly. Replace it when the battery percentage reaches 20%.
- Occasionally wipe out the X2 cartridge deployment bays with a dry cloth. Multiple cartridge firings create carbon build-up (particularly after training courses) that should be removed.

Do not wipe out the X2 bays immediately after the energy weapon has been fired as you might receive a latent short electrical shock. Wait at least five minutes after the last discharge of the X2 energy weapon before wiping out the bays.

- Secure the X2 energy weapon in a protective holster when the energy weapon is not in use.
- Function test the energy weapon regularly.
- Update the energy weapon's firmware when updated firmware is released.
- Download your X2 energy weapon data to Axon Evidence services or your local PC at least once per quarter and always before sending the energy weapon to Axon Enterprise.
- Avoid immersing the X2 energy weapon in water or exposing the X2 energy weapon to excessive moisture or water.
- See the troubleshooting guide at www.axon.com for additional maintenance instructions.

Dropped or Wet X2 Energy Weapon

Do not immerse the energy weapon in water. Any energy weapon loaded with Smart Cartridges that is submerged in water may unexpectedly deploy the cartridges.

Follow these steps for a energy weapon that has been completely submerged in water or exposed to a significant amount of water for an extended period of time.

- 1 Secure the energy weapon in a holster and remove the battery pack as soon as possible.
- 2 Ensure the safety is in the down (SAFE) position.
- 3 Remove the energy weapon from the holster.
- 4 Remove the cartridges. See *Unloading* (Chapter 4) for more information on removing the cartridges.
- 5 Follow the RMA process to submit the energy weapon, cartridge(s), and battery pack to Axon Enterprise.

Follow these steps for a energy weapon exposed to some moisture *but not submerged in water*.

- 1 Point the energy weapon in a safe direction and away from your body.
- 2 Move the safety to the down (SAFE) position.

- 3 Safely remove the battery pack.
- 4 Safely remove all cartridges.
- 5 Let the energy weapon dry out.

Dry the X2 energy weapon thoroughly (at least 24 hours). Do not use an external heat source such as a microwave oven or hair dryer to dry the X2 energy weapon.
- 6 Point the energy weapon in a safe direction and away from your body and ensure that the safety is in the down (SAFE) position.
- 7 Safely reinstall the battery pack.
- 8 Wait one minute before proceeding to the next step. Confirm that the energy weapon or battery pack is not getting warm.
- 9 Move the safety to the up (ARMED) position.
 - If the energy weapon discharges without the trigger being pressed, move the safety to the down (SAFE) position immediately, remove the battery pack, return the energy weapon to Axon per the return policies if the energy weapon is still under warranty.
 - If the energy weapon does not discharge, go to step 10.
- 10 Look at the CID to ensure the X2 energy weapon is functioning properly and the CID is not showing any error icons.
- 11 Confirm that the LASER and flashlight are working properly.
- 12 Press the trigger switch to test the trigger function. Conduct three complete 5-second discharges to confirm the proper pulse rate and observe that the cycle stops at five seconds. See the instructions under *Trigger-Initiated Function Test* for more information.
- 13 Press the ARC switch to test the functioning. See the instructions under *ARC Switch-Initiated Function test* for more information.
- 14 If the trigger or ARC switch does not work, or if the CID shows a critical error icon, move the safety to the down (SAFE) position immediately, remove the battery pack, and return the energy weapon to Axon per the return policies if the energy weapon is still under warranty.
- 15 If the energy weapon does function normally, move the safety to the down (SAFE) position.
- 16 Connect the energy weapon to Evidence Sync and confirm the internal time is correct. See the *Evidence Sync User Manual* for more information.
- 17 Confirm that the three trigger discharges were recorded properly in the download records.
- 18 Return the energy weapon to service.

Online Troubleshooting Guide

A troubleshooting guide is available by visiting www.axon.com. If you need product support on accessories or have any other questions, please contact Axon Enterprise Technical Support at:

U.S.: 1-800-978-2737

Australia: 1800512069

Visit www.axon.com/support for other international telephone numbers.

Product Returns

To return a TASER product for service, first follow the procedures at www.axon.com.

Always perform a complete download from the energy weapon before returning it for RMA. Any data information will be lost during servicing work performed by Axon.

If the TASER energy weapon has been exposed to bodily fluids or other biohazards, please follow your agency guidance and if appropriate contact Axon Enterprise Technical Support at: U.S.: 1-800-978-2737, Australia: 1800512069 (other international numbers can be found at www.axon.com/support) for specific instructions BEFORE returning the energy weapon.

Chapter 6: Optional Accessories

Axon Evidence Services

You can upload the data from your X2 energy weapon using Axon Evidence or Evidence.com Lite services. Evidence.com Lite is a free version of the Axon Evidence (Evidence.com) services and allows downloading the X2 energy weapon, viewing the Trilogy log, and updating the energy weapon software.

The full Axon Evidence pay service allows you to manage video records in addition to your energy weapon records. Visit www.evidence.com for details.

Evidence Sync Software for Offline Mode

The Evidence Sync Software for Offline Mode is intended for energy weapon users who do not have an Axon Evidence or Evidence.com Lite account. Evidence Sync Offline enables you to download a simplified Event log to your local computer and print it. Visit www.evidence.com or www.axon.com for details.

TASER CAM HD Recorder

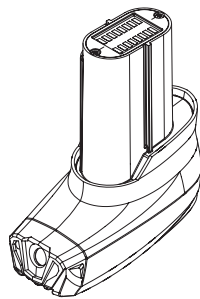

The TASER CAM HD recorder allows users to capture vital information prior to, during, and after deployment or potential deployment of the X2 energy weapon. The TASER CAM HD recorder is an audio-video recording device that replaces the standard battery pack. The TASER CAM HD recorder is activated when the safety is in the up (ARMED) position and there is a boot-up time delay of approximately two seconds after the safety is moved to the up (ARMED) position before it starts to record.

The TASER CAM HD battery is rechargeable and is capable of approximately 100 five-second firings when completely charged. Charging is accomplished through a 110-volt wall adapter through the USB cable.

The TASER CAM HD can record approximately one hour of video at maximum resolution before recording over previous files (continuous loop system).

Video and audio is downloaded via a USB cable and Evidence Sync software to your local computer or to Axon Evidence services.

There also is an automatic shut-down (AS) version of the TASER CAM HD recorder that emits an alarm and shuts down the energy cycle after five seconds, like the APPM.

Holsters

Several holsters are designed for use with the X2 energy weapon. Both right- and left-handed configurations are available. Visit our website at www.axon.com for details.

Chapter 7: Additional Items

Additional Information

New TASER brand products are under development. Visit our website at www.axon.com for the latest information.

Material Safety Data Sheets (MSDS) for lithium batteries are available by contacting Axon.

Axon Academy

The Axon Academy provides training on the use and maintenance of all TASER-brand energy weapons and Axon Evidence (Evidence.com) services. Training is geared toward the special needs of law enforcement officers, correctional officers, medical personnel, military, professional security, and private citizens. energy weapon functions, medical issues, device maintenance, and personal safety are just a few of the topics covered in the offered courses.

Our cadre of instructors consists of active and former law enforcement officers and military trainers. Many are internationally recognized experts in use of force at all levels with extensive training backgrounds.

All of our instructors are committed to providing high-level training and to forming lasting relationships to support our students long after they leave the Axon Academy.

For more information visit our website www.axon.com or give us a call at +1.800.978.2737 option 7 or +1.480.905.2000.

Courses currently offered or in development:

- TASER Conducted Energy Weapon Basic Instructor Course
- TASER Conducted Energy Weapon Master Instructor Course
- Evidence Collection and Analysis
- Body Worn Camera Certification

Medical Research

TASER energy weapons are among the most extensively studied force options. Many energy weapon-related medical and field studies have been published. Medical studies have found that modern pacemakers and implanted cardiac defibrillators withstand automated external defibrillators (AEDs) orders of magnitude stronger than the TASER energy weapon conducted energy pulses. For more information go to www.axon.com.

See the current product warnings, training materials, licensing agreements, and specification sheets for more information about your TASER product.

Radio Waves



An SPPM transmission is in the frequency range of 2402 to 2480 MHz.

Changes or modifications to the equipment not expressly approved by the manufacturer could void the product warranty and the user's authority to operate the equipment.

Your wireless device is a radio transmitter and receiver. It is designed and manufactured not to exceed the emission limits for exposure to radio frequency (RF) energy set by the Federal Communications Commission (FCC) of the U.S. Government. These limits are part of comprehensive guidelines and establish permitted levels of RF energy for the general population. The guidelines are based on standards that were developed by independent scientific organizations through periodic and thorough evaluation of scientific studies. The standards include a substantial safety margin designed to assure the safety of all persons, regardless of age and health. Before a device model is available for sale to the public, it must be tested and certified to the FCC that it does not exceed the limit established by the government adopted requirement for safe exposure. This equipment has been tested and found to comply with the limits for a Class B digital device, pursuant to part 15 of the FCC Rules. These limits are designed to provide reasonable protection against harmful interference in a residential installation. This equipment generates, uses and can radiate radio frequency energy and, if not installed and used in accordance with the instructions, may cause harmful interference to radio communications. However, there is no guarantee that interference will not occur in a particular installation. If this equipment does cause harmful interference to radio or television reception, which can be determined by turning the equipment off and on, the user is encouraged to try to correct the interference by one or more of the following measures:

Reorient or relocate the receiving antenna.

Increase the separation between the equipment and receiver.

Connect the equipment into an outlet on a circuit different from that to which the receiver is connected.

Consult Axon Technical Support for help.

FCC/IC NOTICE: This device meets the body worn human exposure limits found in OET Bulletin 65, 2001, and ANSI/IEEE C95.1, 1992. Proper operation of this equipment according to the instructions found in this guide will result in exposure substantially below the FCC's recommended limits. To comply with the FCC and ANSI C95.1 RF exposure limits, this device has been tested for compliance with FCC RF Exposure limits in the typical configuration. The radiated output power of this wireless device is far below the FCC radio frequency exposure limits.

This device complies with part 15 of the FCC Rules. Operation is subject to the following two conditions: (1) This device may not cause harmful interference, and (2) this device must accept any interference received, including interference that may cause undesired operation.

Section 8.4 of RSS-GEN

This Device complies with Industry Canada License-exempt RSS standard(s). Operation is subject to the following two conditions: 1) this device may not cause interference, and 2) this device must accept any interference, including interference that may cause undesired operation of the device.

Cet appareil est conforme aux normes d'exemption de licence RSS d'Industrie Canada. Son utilisation est soumise aux conditions suivantes : 1) cet appareil ne doit pas causer de brouillage, et 2) doit accepter tout brouillage, y compris le brouillage pouvant entraîner un fonctionnement indésirable.

THIS MODEL DEVICE MEETS THE GOVERNMENT'S REQUIREMENTS FOR EXPOSURE TO RADIO WAVES.

CE Declaration of Conformity

Axon Enterprise, Inc. declares that this Axon system is in compliance with the requirements and other relevant provisions of the Radio Equipment Directive (RED) 2014/53/EU and the Directive 2014/30/EU regarding electromagnetic compatibility. A copy of the original Declaration of Conformity can be found at www.axon.com.

Compliance Marks

MSIP (South Korea) Compliance Information

Applicant Name: Axon Enterprise, Inc.

Manufacturer / Manufacturer Country: Axon Enterprise, Inc. / USA

Name of equipment / model name: Specific low power wireless device (wireless device for wireless data communication system) / T00074

Certification Number: R-CRM-CEW-T00074

Year of manufacture: separate marking

This equipment is intended for home use (Class B) for electromagnetic compatibility and is intended for home use and may be used in all areas.



RCPAXT018-0158



TA-2018/405 APPROVED

AGREE PART L'ANRT MAROC

Numéro d'agrément: MR 18066 ANRT 2018

Date d'agrément: 26 NOV 2018



ANATEL
Agência Nacional de Telecomunicações

03457-19-10342

Este equipamento não tem direito à proteção contra interferência prejudicial e não pode causar interferência em sistemas devidamente autorizados.



เครื่องวิทยุคมนาคมนี้ ได้รับยกเว้น ไม่ต้องได้รับใบอนุญาตให้มี ใช้ซึ่งเครื่องวิทยุคมนาคมหรือตั้งสถานีวิทยุคมนาคมตามประกาศ กสทช. เรื่อง เครื่องวิทยุคมนาคม และสถานีวิทยุคมนาคมที่ได้รับยกเว้นไม่ต้องได้รับใบอนุญาตวิทยุคมนาคม ตามพระราชบัญญัติวิทยุคมนาคม พ.ศ. 2498



nab. | โทรคมนาคม
กำกับดูแลเมื่อประชาชน
Call Center 1200 (Insw5)

CAN ICES-003(B) / NMB-003(B)



NR: 2020-11-I-0823

URCA_TA/2018_102



Axon Enterprise, Inc.
17800 N 85th St
Scottsdale, AZ 85255 USA

Product functions and specifications may change without notice and the actual product may vary from the illustrations in this manual.

Non-Axon trademarks are property of their respective owners.

▲, ▲ AXON, Axon, Axon Evidence, Axon Signal, X2, X26, X26P, TASER, ⚡, and ⚡ are trademarks of Axon Enterprise, Inc., some of which are registered in the US and other countries. For more information, visit www.axon.com/legal.
All rights reserved. © 2025 Axon Enterprise, Inc.

MMU0037 Rev: T