

TECTUS 240 3D : STEEL FRAME

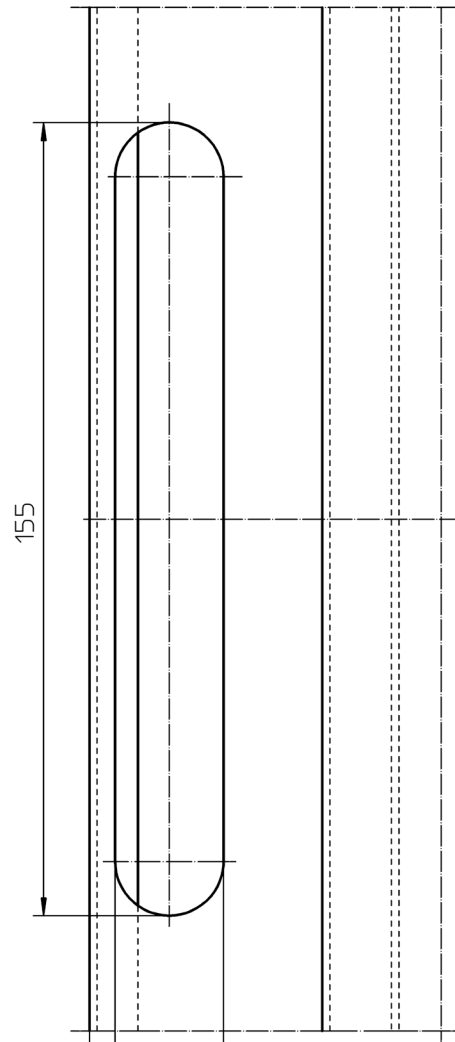

MILLING : FRAME

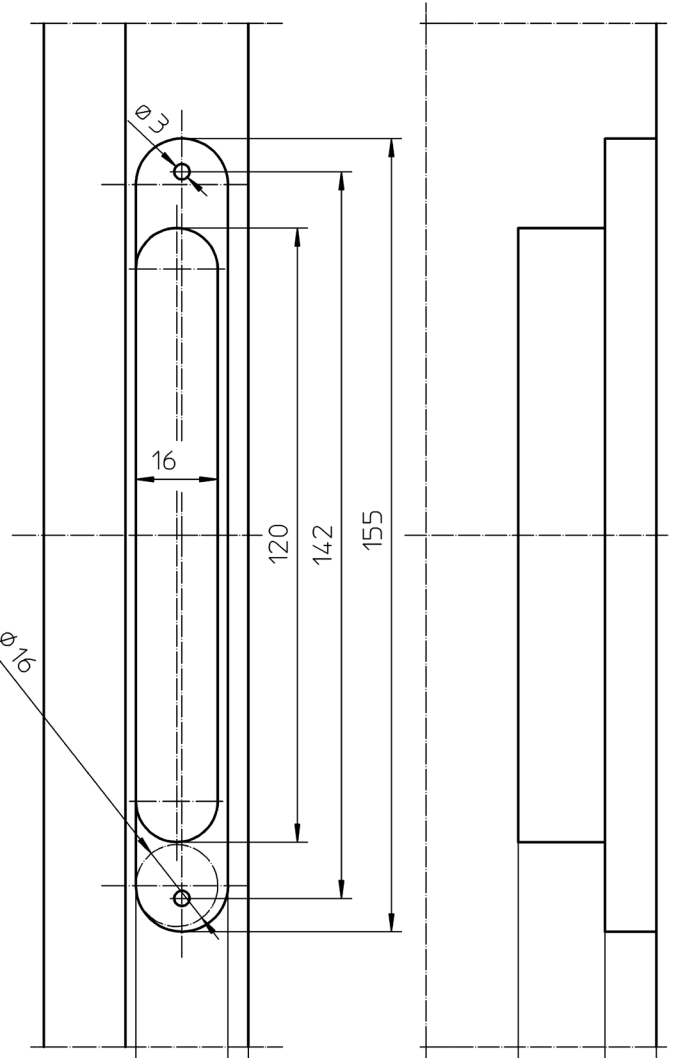
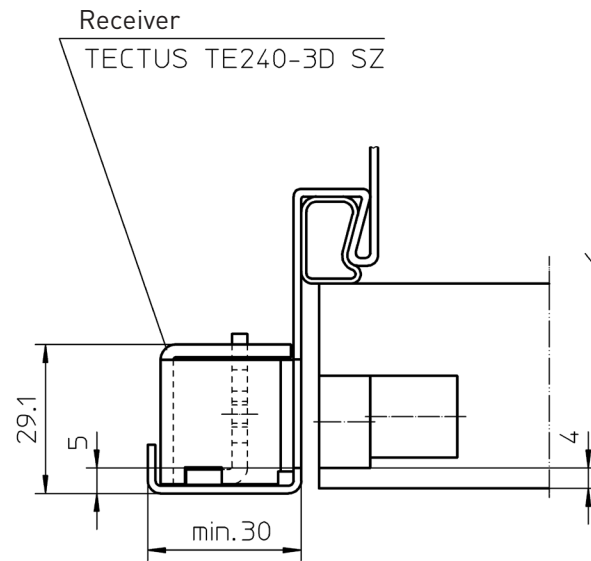

MILLING : DOOR LEAF

fräser : cutter