

*Push*  
your demountable  
partition offering up  
to the next level.



## High-Performance Dropseal Solutions for Wood & Glass Systems

Improve your STC rating with these 7 Swiss-engineered dropseals.

**BW** —  **Planet**

# High-Performance Dropseal Solutions



**NOTE :** Planet has a full suite of dropseals for metal doors as well.

## WOOD



Planet HS-Plus

## GLASS



Planet KG-A Narrow



Planet SN



Planet KG-F Narrow

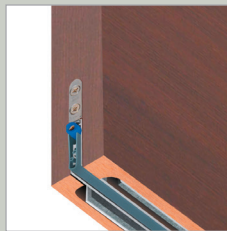

Planet MinE



Planet MinE S10

## WOOD or GLASS



Planet KG - S Narrow

**B ——— W**

available in North America through Bridgeport Worldwide and its dealers

T : +1-800-362-1484 — planet.info@BridgeportWorldwide.com

# Planet HS-plus → 13 x 30 mm | ↓ 22 mm | ⚡ ≥55 dB

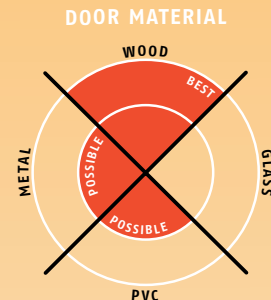

## Main features

- Seal height up to ↓ 22 mm
- Acoustic insulation of ⚡ ≥55 dB in case of an optimal sealing
- Protected silicone lips since deeper embedded
- Door can be adapted on bottom without removal
- Unilateral and soundless release, silent seal
- Due to parallel drop-down no trailing on the floor
- Automatic compensation at inclined floors
- For double leaf doors with flush bolt or driving bar
- High-grade silicone lip, simple lift height adjustment
- Can be shortened up to the next shorter length on stock
- No extra need to cut off silicone at both ends
- 7 years warranty

## Versions / options

- Planet HS-plus → FH+RD ⚡ ≥55 dB, fire-retardant + smoke-shielding
- Option Double-shortening → refer to chapter Accessories | TR125
- Special versions on request

## Door types with Planet HS-plus



Double leaf doors → refer to chapter Accessories | Flush bolt, drilling

## More functions



## Technical specifications

Profile material	aluminum, → 13 x 30 mm
Groove size	□ width 13,1 mm with depth 30,5 up to 40 mm
Seal profile	high-grade silicone or high-grade self-extinguishing silicone
Seal height	up to ↓ 22 mm
Sound absorption value	up to ⚡ ≥55 dB at 7 mm space to the floor; up to ⚡ 51 dB at 14 mm space to the floor
Lift height adjustment	on the release knob with an Allen key 3 mm
Lengths in stock	335, 460, 585, 710, 835, 960, 1085, 1210, 1335, 1460 mm
Special lengths	on request up to 6000 mm for wing- and sliding doors
Release	unilaterally on hinge side
Can be shortened	up to the maximum of 125 mm (335 mm only 115 mm)
Fastening	on the side with stainless steel angle brackets and screws
Frame protector plate	stainless, hammer fixed, 20 x 20 mm
Test approvals	on request

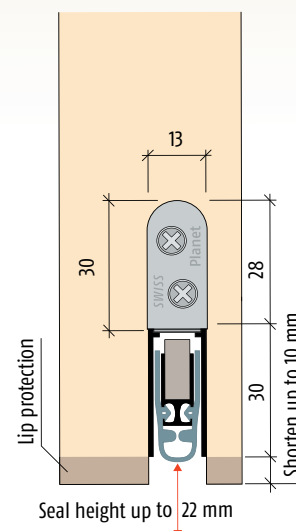

**B** ————— **W**

available in North America through Bridgeport Worldwide and its dealers  
T +1-800-362-1484 — planet.info@BridgeportWorldwide.com

**Planet**  
ASSA ABLOY



Profile Planet HS-plus

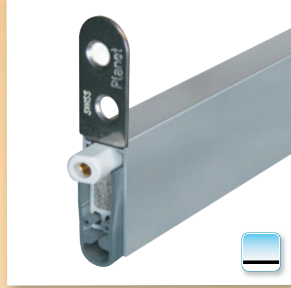

Planet HS-plus with fastening brackets, release knob



Planet assembly set HS

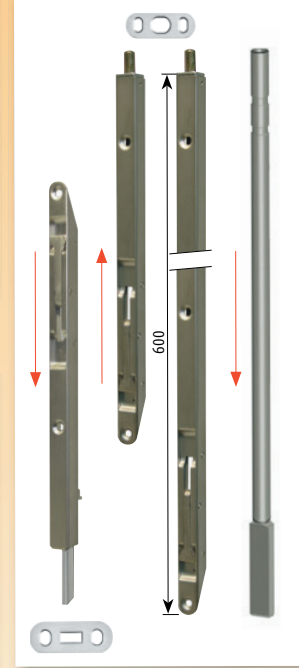

**Accessories:** Planet KR flush bolt, incl. strike plate  
→ see pages 142 – 143  
**Driving bar rods flattened**  
→ see pages 151 – 161

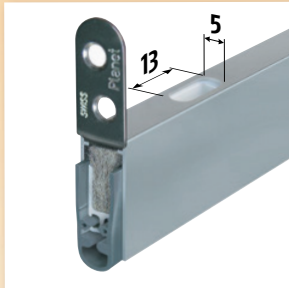

**Option:** Planet HS-plus with Planet drill hole  $\varnothing 5 \times 13$  mm for flush bolt, driving bar rods → refer to chapter Accessories | driving bar rods



**Option:** Planet HS-plus with Planet drill hole  $\varnothing 5 \times 13$  mm and driving bar rod → refer to chapter Accessories | driving bar rods

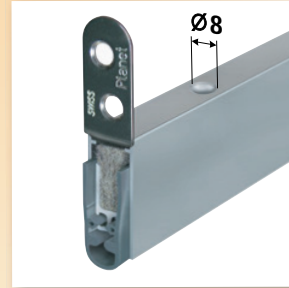

**Option:** Planet HS-plus with Planet drill hole  $\varnothing 8$  mm for driving bar rods → refer to chapter Accessories | driving bar rods

### Order specifications

Planet HS-plus-SD → FH+RD  $\leftarrow \leq 55$  dB  
incl. assembly set HS

Prod. code 77xxx-SD\*

\* xxx = refer to price list for profile length

### Accessories | Options

<b>Planet assembly set HS</b> incl. 2 fastening brackets (stainless), 4 screws and frame protector plate, type 1 (stainless)	Prod. code 900180
<b>Planet frame protector plate</b> type 1 (stainless); possible type 2/3/4/5 → refer to chapter Accessories   Options	Prod. code 900014
<b>Cut the Planet to fix dimension</b>	Prod. code 900200
<b>Planet drill hole <math>\varnothing 8</math> mm</b>	Prod. code 900866
<b>Planet drill hole <math>\varnothing 5 \times 13</math> mm</b> including plastic guide, for Planet KR and driving bar rods flattened → refer to chapter Accessories   Flush bolt, drilling	Prod. code 900190
<b>Planet BM floor strikes</b> → refer to chapter Accessories   BM	Prod. code 90034x-x Prod. code 90027x-x

x-x = Several Planet Floor strikes available in different adjustment range  
refer to chapter Accessories | BM

### Advertising text



Planet HS-plus → FH+RD (fire-retardant + smoke-shielding)  $\leftarrow \leq 55$  dB

Automatic door drop-down seal Planet HS-plus → FH+RD  $\leftarrow \leq 55$  dB, for sound protection-, smoke-shielding and fire-retardant doors, release on hinge side with automatic compensation in case of an inclined floor, parallel drop-down, seal height up to  $\downarrow 22$  mm, flush or deeper to put in groove with lip protection. Lateral fastening, self-extinguishing silicone lip. Aluminum profile → 13 x 30 mm.

# Planet SN (sliding door) → 22 x 30 mm | ↓ 7-16 mm | ≤ 44 dB



## Main features

- Planet SN for sliding doors
- No lock needed because of **zero-force release**
- Seal height ↓ **7-16 mm**
- Floor guide SN kit – versions short (standard) and long (as option) – **for door gap 7-10 / 10-13 / 13-16 mm**
- Release force only **1 N/m**
- Release through floor guide with parallel drop-down
- Compact space-saving solution with integrated floor guiding groove
- Automatic compensation at inclined floors
- Acoustic insulation up to ≤ **44 dB** in case of an optimal sealing (at an air-gap of 7 mm)
- High-grade silicone lip
- Can be shortened up to the next shorter length on stock
- Seal easily removed by detaching end brackets
- 7 years warranty



## Versions / options

- Planet SN → RD ≤ **44 dB**, smoke-shielding
- Closing **DIN L** or **DIN R**
- Special versions on request

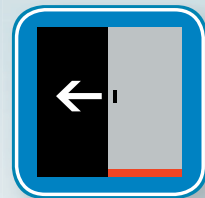

## Door types with Planet SN



## More functions



## Technical specifications

Profile material	aluminum, → <b>22 x 30 mm</b>
Groove size	width 22,1 mm with depth 30,5 up to 35 mm
Seal profile	high-grade silicon
Seal height	↓ <b>7-16 mm</b>
Floor guides	incl. 3 pcs. for door gap <b>7-10 / 10-13 / 13-16 mm</b>
Sound absorption value	up to ≤ <b>44 dB</b> at 7 mm space to the floor
Lengths in stock	800, 925, 1050, 1175, 1300, 1425, 1550, 1675 mm
Special lengths	on request up to 6000 mm
Release	integrated in the floor guide → <b>invisible</b>
Can be shortened	125 mm (+ 45 mm max. at gearing side)
Fastening	laterally with stainless steel angle brackets
Test approvals	on request

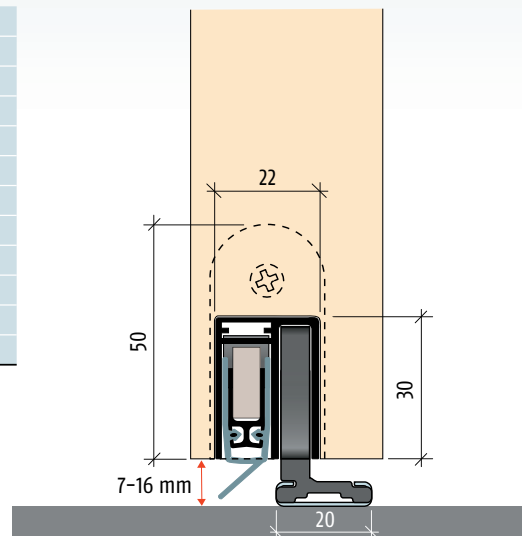

**B** ————— **W**

available in North America through Bridgeport Worldwide and its dealers  
T +1-800-362-1484 — planet.info@BridgeportWorldwide.com

**Planet**  
ASSA ABLOY



Planet SN profile with floor guide



Planet assembly set SN

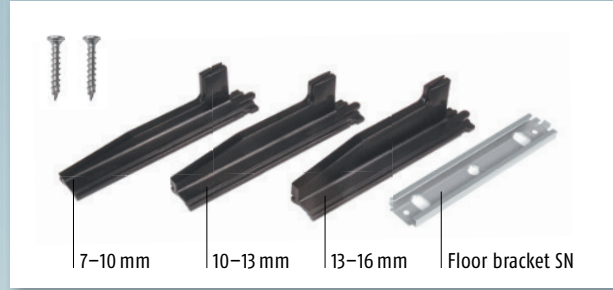

Floor guide SN kit short (standard) including 3 ramped guides SN for door gap 7–16 mm and floor bracket SN for screwing



Planet SN installed



Planet SN installed with floor guide SN

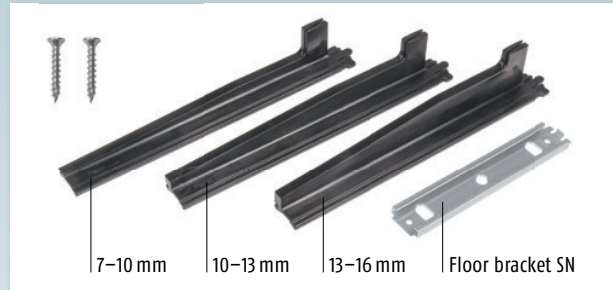

Floor guide SN kit long (option) including 3 ramped guides SN long for door gap 7–16 mm and floor bracket SN for screwing

**Order specifications**

Planet SN → RD ≤ 44 dB incl. Planet assembly Set SN and floor guide SN kit, short for door gap 7–16 mm	Prod. code 105xxx L   R*
Closing DIN L or DIN R → refer to illustration on the right	

\* xxx = refer to price list for profile length

**Accessories | Options**

Planet floor guide SN kit, short, DIN R for door gap 7–10 / 10–13 / 13–16 mm (standard)	Prod. code 902035
Planet floor guide SN kit, short, DIN L for door gap 7–10 / 10–13 / 13–16 mm (standard)	Prod. code 902036
Planet floor guide SN kit, long, DIN R for door gap 7–10 / 10–13 / 13–16 mm (option)	Prod. code 902037
Planet floor guide SN kit, long, DIN L for door gap 7–10 / 10–13 / 13–16 mm (option)	Prod. code 902038
Planet assembly Set SN for wood, DIN R	Prod. code 902033
Planet assembly Set SN for wood, DIN L	Prod. code 902034

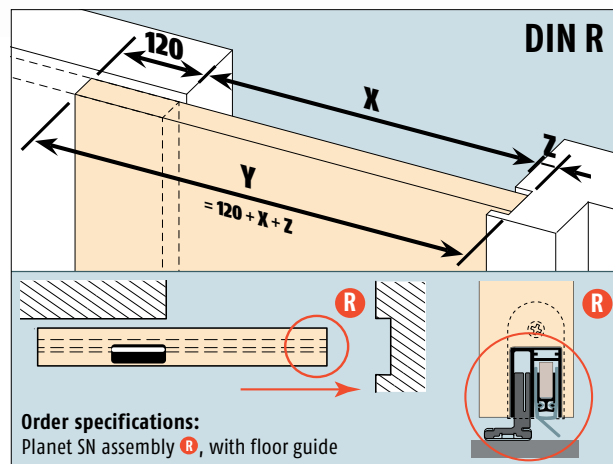
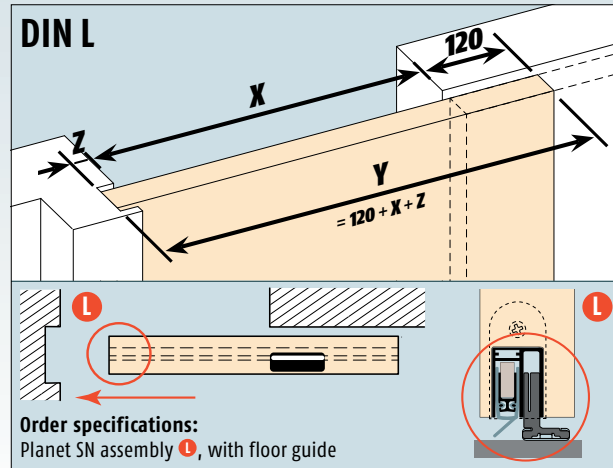

**Advertising text**

Planet SN → RD (smoke-shielding) ≤ 44 dB

Automatic door drop-down seal Planet SN → RD ≤ 44 dB, for sound absorption and smoke-shielding sliding doors, release through floor guide with parallel drop-down, seal height ↓ 7–10 / 10–13 / 13–16 mm, flush to put in groove. Silicone lip, lateral fastening incl. floor guide. Aluminum profile → 22 x 30 mm.

# Planet MinE-F / S (F= rebated doors / S= soundproof)

→ 8 x 30 mm / 25 x 43 mm | ↓ 20 mm | ≤ 27 dB

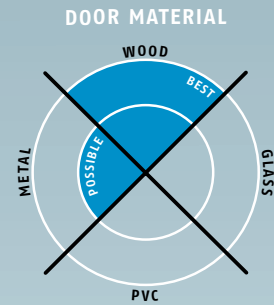

## Main features

- Especially for passive building and low energy houses
- Suitable for rebated doors
- Closed rooms with Ventilation systems / toilet / bathroom
- Air circulation / air equalization
- Seal height up to ↓ 20 mm
- Sound absorption on seam ≤ 27 dB at an air-gap of 7 mm
- Increased sound absorption at simultaneous air passage
- Air passage 200 m³/h
- Reading 30 m³/h at a pressure difference of 3,9 Pa (door width 1050 mm)
- High-grade silicone lip, simple lift height adjustment
- Compensation of 15 mm in case of sloping floor at door width of 1000 mm
- Automatic compensation at inclined floors
- No extra need to cut off silicone at both ends
- 7 years warranty

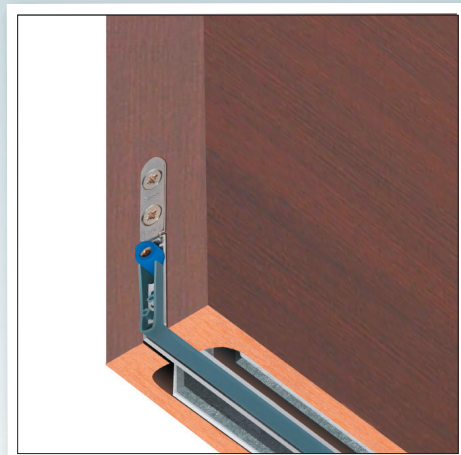

## Versions / options

- Planet MinE-F / S ≤ 27 dB
- Planet MinE-F / S → FH ≤ 27 dB, fire-retardant
- Airlock doors
- Special versions on request

## Door types with MinE-F / S



Double leaf doors → please use Planet MinE-S.

## More functions



## Technical specifications

Profile material	aluminum, → 8 x 30 mm
Channel material	aluminum, → 25 x 43 mm
Groove size	□ width 25,1 mm with depth 43,5 mm / □ width 8,1 mm with depth 30,5 mm
Seal profile	high-grade silicone or high-grade self-extinguishing silicone
Seal height	up to ↓ 20 mm
Sound absorption value	up to ≤ 27 dB at 7 mm space to the floor
Air passage	30 m³/h at an aeration length of 1050 mm and a pressure difference of 3,9 Pa
Lift height adjustment	on the release knob with an Allen key 3 mm
Lengths in stock	460, 585, 710, 835, 960, 1085, 1210, 1335, 1460 mm
Special lengths	on request up to 2000 mm, sliding doors up to 1600 mm
Release	unilaterally on hinge side
Can be shortened	up to the maximum of 125 mm
Fastening	on the side with stainless steel angle brackets and screws
Frame protector plate	stainless, hammer fixed, 20 x 20 mm
Test approvals	on request

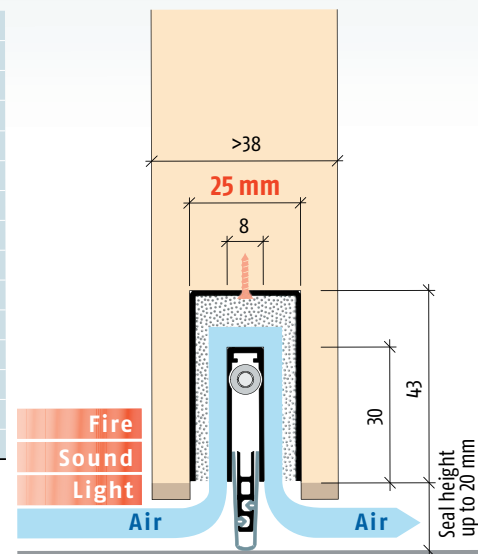

**B** ————— **W**

available in North America through Bridgeport Worldwide and its dealers  
T +1-800-362-1484 — planet.info@BridgeportWorldwide.com

**Planet**  
ASSA ABLOY



Planet MinE-F/S-drop-down seal



Planet MinE-F/S with fastening brackets, channel and insulation



Planet assembly set MinE-F

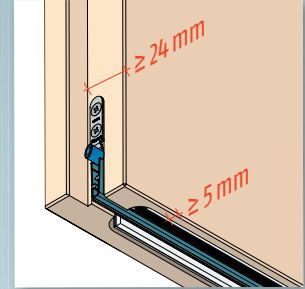

Planet MinE-F/S, installed in rebated door



**Option:** Planet MinE-F/S with bevel lip for **uneven floors**

### Order specifications

<b>Planet MinE-F/S</b> $\leq 27$ dB incl. assembly set MinE-F	Prod. code 40xxx-F*
<b>Planet MinE-F/S</b> $\rightarrow$ FH $\leq 27$ dB incl. assembly set MinE-F	Prod. code 41xxx-F*

\* xxx = refer to price list for profile length

### Accessories | Options

<b>Planet MinE-F assembly set</b> incl. 2 fastening brackets (stainless), 8 screws and frame protector plate, type 1 (stainless)	Prod. code 900828
<b>Planet frame protector plate</b> type 1 (stainless); possible type 2/3/4/5 $\rightarrow$ refer to chapter Accessories   Options	Prod. code 900014
<b>Cut the Planet to fix dimension</b>	Prod. code 900225
<b>Sliding door</b>	Prod. code 900908

### Advertising text

**Planet MinE-F/S**  $\leq 27$  dB  
Automatic door drop-down seal **Planet MinE-F/S**  $\leq 27$  dB for rebated sound absorption doors with an air passage, release on hinge side and automatic compensation at inclined floor, parallel drop-down, seal height up to  $\downarrow 20$  mm, lip from high quality silicone, lateral fastening, profiles from aluminum  $\rightarrow 8 \times 30$  mm /  $25 \times 43$  mm, MinE-F channel and floor seal equipped with sound absorption materials.



### Advertising text



**Planet MinE-F/S**  $\rightarrow$  FH (fire-retardant)  $\leq 27$  dB  
Automatic door drop-down seal **Planet MinE-F/S**  $\rightarrow$  FH  $\leq 27$  dB for rebated fire-retardant sound absorption doors with an air passage, release on hinge side with automatic compensation at inclined floor, equipped with intumescent strips. Parallel drop-down, seal height up to  $\downarrow 20$  mm, self-extinguishing silicone lip, lateral fastening, profiles from aluminum  $\rightarrow 8 \times 30$  mm /  $25 \times 43$  mm, MinE-F channel and floor seal equipped with sound absorption materials.



# Planet KG-A8 | A10 | A12 narrow

→ 11,5 x 38 mm | ↓ 16mm | ≤ 48 dB

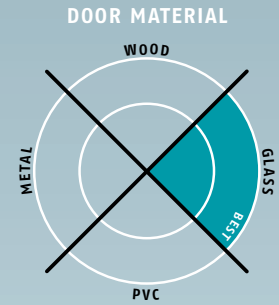

## Main features

- Seal height up to ↓ 16 mm
- Acoustic insulation up to ≤ 48 dB in case of an optimal sealing
- For one and double leaf folding all-glass doors, with a glass thickness of 8, 10 and 12 mm
- Planet KG-A8 | A10 | A12 narrow to be attached and glued
- Planet drop-down seal cemented in KG-A8 | A10 | A12 narrow protection profile
- Unilateral and soundless release, silent seal
- Due to parallel drop-down no trailing on the floor
- Automatic compensation at inclined floors
- High-grade silicone lip, simple lift height adjustment
- Can be shortened up to the next shorter length on stock
- 7 years warranty

## Versions / options

- Planet KG-A8 | A10 | A12 narrow → RD ≤ 48 dB, smoke-shielding
- Planet KG-A8 | A10 | A12 narrow → FH+RD ≤ 48 dB, fire-retard. + smoke-shield.
- Option **bevel lip** ≤ 44 dB, up to ↓ 20 mm, for uneven floors
- Special versions on request

## Surfaces

- Protection profile **silver anodised EV1**
- Protection profile **stainless steel satin anodised**

## Door types with Planet KG-A8 | A10 | A12 narrow



## More functions



## Technical specifications

Profile material	aluminum, → 11,5 x 38 mm, silver anodised EV1 or stainless steel satin anodised
Seal profile	high-grade silicone or high-grade self-extinguishing silicone
Seal height	up to ↓ 16 mm
Sound absorption value	up to ≤ 48 dB at 7 mm space to the floor; up to ≤ 46 dB at 14 mm space to the floor
Lift height adjustment	on the release knob with an Allen key 3 mm
Lengths in stock	459, 584, 709, 834, 959, 1084, 1209, 1334, 1459 mm
Special lengths	on request up to 6000 mm, sliding doors up to 1600 mm
Release	unilaterally on hinge side
Can be shortened	up to the maximum of 125 mm
Fastening	to be glued
Frame protector plate	stainless, hammer fixed, 20 x 20 mm
Test approvals	on request

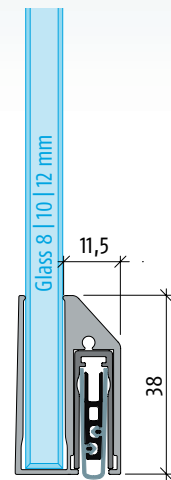

Seal height ↑ up to 16 mm



**B** ————— **W**

available in North America through Bridgeport Worldwide and its dealers  
T +1-800-362-1484 — planet.info@BridgeportWorldwide.com

**Planet**  
ASSA ABLOY



Planet KG-A8 | A10 | A12 narrow, attached and glued



Planet KG-A8 | A10 | A12 narrow, attached and glued release side



Planet KG-A8 | A10 | A12 narrow, with cover plate



**Option:** Planet KG-A8 | A10 | A12 narrow, bevel lip for uneven floors



**Accessories:** Planet frame protector plate, type 1 (stainless), 20x20 mm



Cover plates Planet KG-A narrow

**Order specifications**

Planet KG-A8   A10   A12 narrow → RD ⊲ 48 dB, → silver anodised EV1 incl. set of cover plates and frame protector plate, type 1	Prod. code 38xxx-A8s   A10s   A12s*
Planet KG-A8   A10   A12 narrow → FH+RD ⊲ 48 dB, → silver anodised EV1 incl. set of cover plates and frame protector plate, type 1	Prod. code 39xxx-A8s   A10s   A12s*
Planet KG-A8   A10   A12 narrow → RD ⊲ 48 dB, → stainless steel satin anodised incl. set of cover plates and frame protector plate, type 1	Prod. code 38xxx-A8Xs   A10Xs   A12Xs*
Planet KG-A8   A10   A12 narrow → FH+RD ⊲ 48 dB, → stainless steel satin anodised incl. set of cover plates and frame protector plate, type 1	Prod. code 39xxx-A8Xs   A10Xs   A12Xs*

\* xxx = refer to price list for profile length

**Accessories | Options**

Planet frame protector plate type 1 (stainless); possible type 2/3/4/5 → refer to chapter Accessories   Options	Prod. code 900014
Cut the Planet to fix dimension	Prod. code 900225
Set of Planet cover plates KG-A/F10 narrow	Prod. code 902074
Sliding door	Prod. code 900908
Bevel lip (⊲ 44 dB, up to ↓ 20 mm) DIN L or DIN R	refer to price list, options / supplements

**Advertising text**



**Planet KG-A8 | A10 | A12 narrow → RD (smoke-shielding) ⊲ 48 dB**  
Automatic door drop-down seal Planet KG-A8 | A10 | A12 narrow → RD ⊲ 48 dB, unilateral release with parallel drop-down and automatic compensation at inclined floor, protection profile silver anodised EV1 or stainless steel satin anodised, to be attached and glued, seal height up to ↓ 16 mm. Lip from silicone. Protection profile and profile made from aluminum → 11,5 x 38 mm, incl. cover plate on lock side for folding doors.

**Advertising text**



**Planet KG-A8 | A10 | A12 narrow → FH+RD (fire-retardant + smoke-shielding) ⊲ 48 dB**  
Automatic door drop-down seal Planet KG-A8 | A10 | A12 narrow → RD+FH ⊲ 48 dB, appropriate for fire-retardant and smoke-shielding doors, sound absorption value SK 1-3, unilateral release with parallel drop-down and automatic compensation at inclined floor, protection profile silver anodised EV1 or stainless steel satin anodised, to be attached and glued, seal height up to ↓ 16 mm. Lip from silicone. Protection profile and profile made from aluminum → 11,5 x 38 mm, incl. cover plate on lock side for folding doors.

# Planet KG-F8 | F10 narrow

→ 11,5 / 13,5 x 46 mm | ↓ 16 mm | ≤ 48 dB

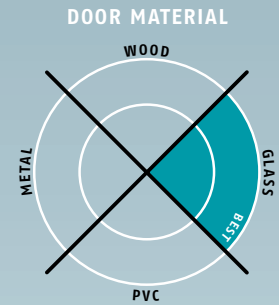

## Main features

- Seal height up to ↓ 16 mm
- Acoustic insulation up to ≤ 48 dB in case of an optimal sealing
- For one and double leaf all-glass doors, with a thickness of 8 and 10 mm or LSG
- Planet KG-F8|F10 to be attached and glued
- Planet drop-down seal cemented in F8|F10 narrow protection profile
- Unilateral and soundless release, silent seal
- Due to parallel drop-down no trailing on the floor
- Automatic compensation at inclined floors
- High-grade silicone lip, simple lift height adjustment
- Can be shortened up to the next shorter length on stock
- 7 years warranty

## Versions / options

- Planet KG-F8|F10 narrow → RD ≤ 48 dB, smoke-shielding
- Planet KG-F8|F10 narrow → FH+RD ≤ 48 dB, fire-retardant and smoke-shielding
- Option bevel lip ≤ 44 dB, up to ↓ 20 mm, for uneven floors 
- Special versions on request

## Surfaces

- Protection profile silver anodised EV1
- Protection profile stainless steel satin anodised

## Door types with Planet KG-F8|F10 narrow



## More functions



## Technical specifications

Profile material	aluminum, → 11,5 / 13,5 x 46 mm, silver anodised EV1 or stainless steel satin anodised
Seal profile	high-grade silicone or high-grade self-extinguishing silicone
Seal height	up to ↓ 16 mm
Sound absorption value	up to ≤ 48 dB at 7 mm space to the floor; up to ≤ 47 dB at 14 mm space to the floor
Lift height adjustment	on the release knob with an Allen key 3 mm
Lengths in stock	459, 584, 709, 834, 959, 1084, 1209, 1334, 1459 mm
Special lengths	on request up to 6000 mm, sliding doors up to 1600 mm
Release	unilaterally on hinge side
Can be shortened	up to the maximum of 125 mm
Fastening	to be glued
Frame protector plate	stainless, hammer fixed, 20 x 20 mm
Test approvals	on request

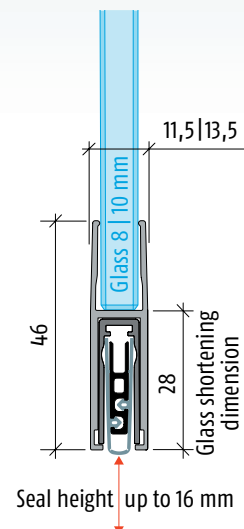

**B** — **W**

available in North America through Bridgeport Worldwide and its dealers  
T +1-800-362-1484 — planet.info@BridgeportWorldwide.com

**Planet**  
ASSA ABLOY



Planet KG-F8|F10 narrow, with cover plate



Planet KG-F8|F10 narrow, attached and glued, release side



Planet KG-F8|F10 narrow, attached and glued



**Option:** Planet KG-F8|F10 narrow, bevel lip for uneven floors



**Accessories:** Planet frame protector plate, type 1 (stainless), 20 x 20 mm



Planet KG cover plate

### Order specifications

Planet KG-F8 F10 narrow → RD ≤ 48 dB → silver anodised EV1 incl. set of cover plates and frame protector plate, type 1	Prod. code 38xxx-F8s   F10s*
Planet KG-F8 F10 narrow → FH+RD ≤ 48 dB → silver anodised EV1 incl. set of cover plates and frame protector plate, type 1	Prod. code 39xxx-F8s   F10s*
Planet KG-F8 F10 narrow → RD ≤ 48 dB → stainless steel satin anodised incl. set of cover plates and frame protector plate, type 1	Prod. code 38xxx-F8Xs   F10Xs*
Planet KG-F8 F10 narrow → FH+RD ≤ 48 dB → stainless steel satin anodised incl. set of cover plates and frame protector plate, type 1	Prod. code 39xxx-F8Xs   F10Xs*

\* xxx = refer to price list for profile length

### Accessories | Options

Planet frame protector plate type 1 (stainless); possible type 2/3/4/5 → refer to chapter Accessories   Options	Prod. code 900014
Cut the Planet to fix dimension	Prod. code 900225
Set of Planet cover plates KG-S / F8 narrow	Prod. code 900836
Set of Planet cover plates KG-A / F10 narrow	Prod. code 902074
Sliding door	Prod. code 900908
Bevel lip (≤ 44 dB, up to ↓ 20 mm) DIN L or DIN R	refer to price list, options / supplements

### Advertising text



#### Planet KG-F8|F10 narrow → RD (smoke-shielding) ≤ 48 dB

Automatic door drop-down seal Planet KG-F8|F10 narrow → RD ≤ 48 dB, unilateral release with parallel drop-down and automatic compensation at inclined floor, protection profile silver anodised EV1 or stainless steel satin anodised, to be attached and glued, seal height up to ↓ 16 mm. Lip from silicone. Protection profile and profile made from aluminum → 11,5 / 13,5 x 46 mm, incl. cover plate on lock side for single leaf doors.

### Advertising text



#### Planet KG-F8|F10 narrow → FH+RD (fire-retardant + smoke-shielding) ≤ 48 dB

Automatic door drop-down seal Planet KG-F8|F10 narrow → FH+RD ≤ 48 dB, appropriate for fire-retardant and smoke-shielding doors, sound absorption value SK 1-3, unilateral release with parallel drop-down and automatic compensation at inclined floor, protection profile silver anodised EV1 or stainless steel satin anodised, to be attached and glued, seal height up to ↓ 16 mm. Lip from silicone. Protection profile and profile made from aluminum → 11,5 / 13,5 x 46 mm, incl. cover plate on lock side for single leaf doors.

# Planet KG-F12s | F16s

→ 16,5 / 19,5 x 46 mm | ↓ 18 mm | ≤ 48 dB

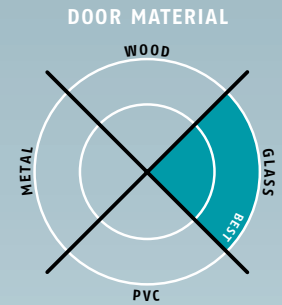

## Main features

- Seal height up to ↓ 18 mm
- Acoustic insulation up to ≤ 48 dB in case of an optimal sealing
- For one and double leaf all-glass doors, with a thickness of 12 and 16 mm (16 mm glass thickness is suitable for fire doors)
- To be attached and glued
- Planet drop-down seal cemented in protection profile
- Unilateral and soundless release, silent seal
- Due to parallel drop-down no trailing on the floor
- Automatic compensation at inclined floors
- High-grade silicone lip, simple lift height adjustment
- Can be shortened up to the next shorter length on stock
- 7 years warranty

## Versions / options

- Planet KG-F12s | F16s → RD ≤ 48 dB, smoke-shielding
- Planet KG-F12s | F16s → FH+RD ≤ 48 dB, fire-retardant and smoke-shielding
- Option bevel lip ≤ 44 dB, up to ↓ 22 mm, for uneven floors
- Special versions on request

## Surfaces

- Protection profile silver anodised EV1
- Protection profile stainless steel satin anodised

## Door types with Planet KG-F10 | F12



## More functions



## Technical specifications

Profile material	aluminum, → 16,5/19,5 x 46 mm, silver anodised EV1 or stainless steel satin anodised
Seal profile	high-grade silicone or high-grade self-extinguishing silicone
Seal height	up to ↓ 18 mm
Sound absorption value	up to ≤ 48 dB at 7 mm space to the floor; up to ≤ 46 dB at 14 mm space to the floor
Lift height adjustment	on the release knob with an Allen key 3 mm
Lengths in stock	459, 584, 709, 834, 959, 1084, 1209, 1334, 1459 mm
Special lengths	on request up to 6000 mm, sliding doors up to 1600 mm
Release	unilaterally on hinge side
Can be shortened	up to the maximum of 125 mm
Fastening	to be glued
Frame protector plate	stainless, hammer fixed, 20 x 20 mm
Test approvals	on request

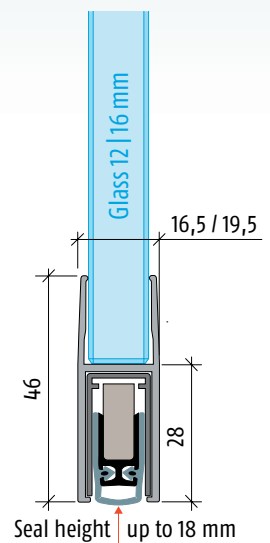

**B** — **W**

available in North America through Bridgeport Worldwide and its dealers  
T +1-800-362-1484 — planet.info@BridgeportWorldwide.com

**Planet**  
ASSA ABLOY

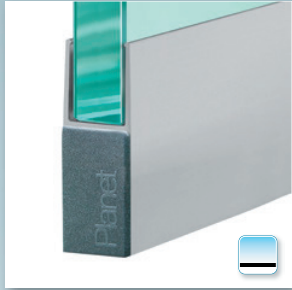

Planet KG-F12s | F16s, with cover plate



Planet KG-F12s | F16s, attached and glued, release side



Planet G-F12s | F16s, attached and glued

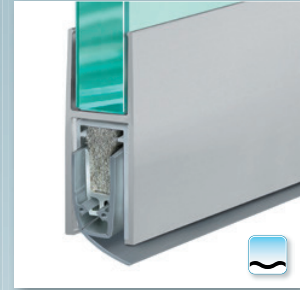

**Option:** Planet G-F12s | F16s, bevel lip for uneven floors



**Accessories:** Planet frame protector plate, type 1 (stainless), 20 x 20 mm



Cover plate Planet G-F12s | F16s

### Order specifications

Planet KG-F12s   F16s → RD ≤ 48 dB → silver anodised EV1 incl. set of cover plates and frame protector plate, type 1	Prod. code 38xxx-F12s   F16s*
Planet KG-F12s   F16s → FH+RD ≤ 48 dB → silver anodised EV1 incl. set of cover plates and frame protector plate, type 1	Prod. code 39xxx-F12s   F16s*
Planet KG-F12s   F16s → RD ≤ 48 dB → stainless steel satin anodised incl. set of cover plates and frame protector plate, type 1	Prod. code 38xxx-F12Xs   F16Xs*
Planet KG-F12s   F16s → FH+RD ≤ 48 dB → stainless steel satin anodised incl. set of cover plates and frame protector plate, type 1	Prod. code 39xxx-F12Xs   F16Xs*

\* xxx = refer to price list for profile length

### Accessories | Options

Planet frame protector plate type 1 (stainless); possible type 2/3/4/5 → refer to chapter Accessories   Options	Prod. code 900014
Cut the Planet to fix dimension	Prod. code 900225
Set of Planet cover plates Planet KG-F12s   F16s	Prod. code 902252
Sliding door	Prod. code 900908
Bevel lip (≤ 44 dB, up to ↓ 22 mm)	refer to price list, options / supplements

### Advertising text



Planet KG-F12s   F16s → RD (smoke-shielding) ≤ 48 dB
Automatic door drop-down seal Planet KG-F12s   F16s → RD ≤ 48 dB, unilateral release with parallel drop-down and automatic compensation at inclined floor, protection profile silver anodised EV1 or stainless steel satin anodised, to be attached and glued, seal height up to ↓ 18 mm. Lip from silicone. Protection profile and profile made from aluminum → 16,5/19,5 x 46 mm, incl. cover plate on lock side for single leaf doors.

### Advertising text



Planet KG-F12s   F16s → FH+RD (fire-retardant + smoke-shielding) ≤ 48 dB
Automatic door drop-down seal Planet KG-F12s   F16s → FH+RD ≤ 48 dB, appropriate for fire-retardant and smoke-shielding doors, unilateral release with parallel drop-down and automatic compensation at inclined floor, protection profile silver anodised EV1 or stainless steel satin anodised, to be attached and glued, seal height up to ↓ 18 mm. Lip from silicone. Protection profile and profile made from aluminum → 16,5/19,5 x 46 mm, incl. cover plate on lock side for single leaf doors.

# Planet KG-MinE-S10

→ 34 x 45 / 61 mm | ↓ 27 mm | ≤ 27 dB

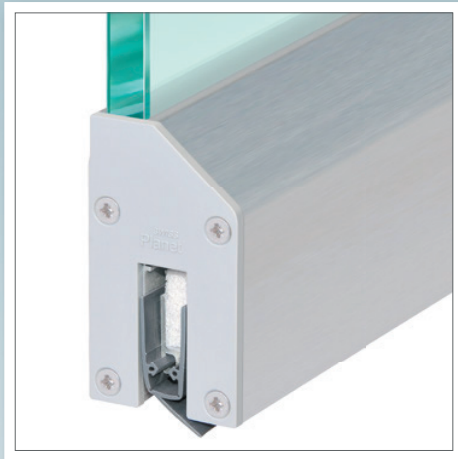
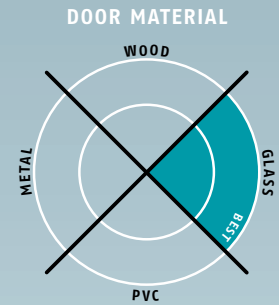

## Main features

- Especially for passive building and low energy houses
- Closed rooms with ventilation systems / toilet / bathroom
- Air circulation / air equalization
- Seal height up to ↓ 27 mm
- Acoustic insulation up to ≤ 27 dB in case of an optimal sealing
- For one and double leaf folding all-glass doors, glass thickness from 10 mm
- Air passage 200 m<sup>3</sup>/h
- Readings 30 m<sup>3</sup>/h at a pressure difference of 3,9 Pa (with door width 1050 mm)
- Planet KG-MinE-S10 to be attached and glued
- For wavy, buckled, hollow, bevelled and uneven floor
- Soft silicone bevel lip seal, perfect for uneven floors
- No trailing on the floor
- 7 years warranty

## Versions / options

- Planet KG-MinE-S10 ≤ 27 dB
- Special versions on request

## Surfaces

- Protection profile silver anodised EV1
- Protection profile stainless steel satin anodised

## Door types with Planet KG-MinE-S10



## More functions



## Technical specifications

Profile material	aluminum, → 13 x 30 mm
Channel material	aluminum, → 34 x 61 mm
Seal profile	high-grade silicone or high-grade self-extinguishing silicone
Seal height	up to ↓ 27 mm
Sound absorption value	up to ≤ 27 dB at 7 mm space to the floor
Luftdurchlass	30 m <sup>3</sup> /h at an aeration length of 1050 mm and a pressure difference of 3,9 Pa
Lift height adjustment	on the release knob with an Allen key 3 mm
Lengths in stock	335, 460, 585, 710, 835, 960, 1085, 1210, 1335, 1460 mm
Special lengths	on request up to 2000 mm, sliding doors up to 1600 mm
Release	unilaterally on hinge side
Can be shortened	up to the maximum of 125 mm (335 mm only 115 mm)
Fastening	to be glued
Frame protector plate	stainless, hammer fixed, 20 x 20 mm
Test approvals	on request

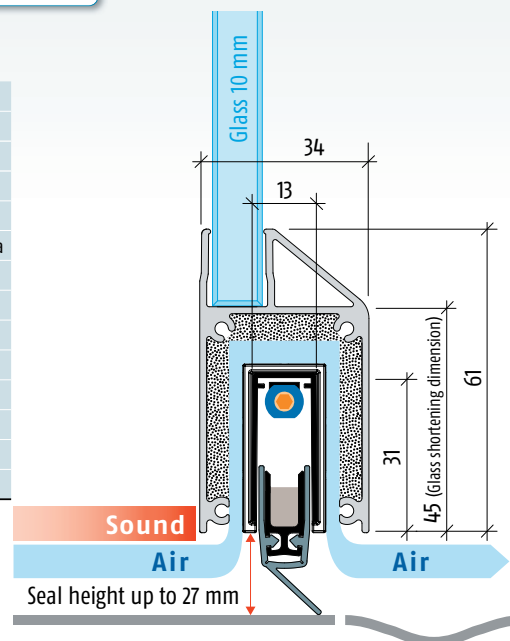

**B ——— W**

available in North America through Bridgeport Worldwide and its dealers  
T +1-800-362-1484 — planet.info@BridgeportWorldwide.com

**Planet**  
ASSA ABLOY



Planet KG-MinE-S10, release side



Planet KG-MinE-S10 with channel and insulation



Planet KG-MinE-S10 cover plates



Planet frame protector, type 1

### Order specifications

**Planet KG MinE-S10**  $\leq 27$  dB

→ silver anodised EV1

incl. set of cover plates and frame protector plate, type 1

Prod. code 38xxx-MinE-S10 L/R\*

**Planet KG MinE-S10**  $\leq 27$  dB

→ stainless steel satin anodised

incl. set of cover plates and frame protector plate, type 1

Prod. code 38xxx-MinE-S10X L/R\*

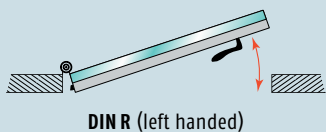

DIN R (left handed)

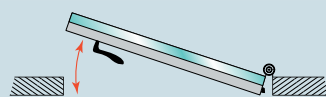

DIN L (right handed)

\* xxx = refer to price list for profile length

### Accessories | Options

**Planet frame protector plate**

type 1 (stainless); possible type 2/3/4/5

→ refer to chapter Accessories | Options

Prod. code 900014

**Cut the Planet to fix dimension**

Prod. code 900225

### Advertising text



**Planet KG-MinE-S10**  $\leq 27$  dB

Automatic door drop-down seal **Planet KG-MinE-S10**  $\leq 27$  dB for sound absorption glass doors with an air passage, especially for uneven floors, release on hinge side and automatic compensation at inclined floor, parallel drop-down, seal height up to  $\downarrow 27$  mm, lip from high quality silicone, KG-MinE-S10-channel in silver anodised EV1 or stainless steel satin anodised, to be attached and glued, profiles from aluminum → **13 x 30 mm / 34 x 61 mm**, KG-MinE-S10-channel equipped with sound absorption materials.



# Planet KG-S narrow

→ 11,5 x 38 mm | ↓ 16mm | ≦ 48 dB

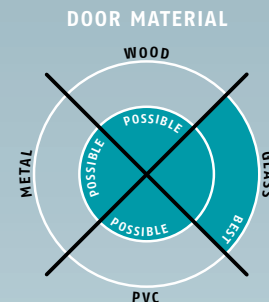

## Main features

- Seal height up to ↓ 16 mm
- Acoustic insulation up to ≦ 48 dB in case of an optimal sealing
- Planet KG-S narrow laterally pasted with UV cement or double adhesive tape
- Unilateral and soundless release, silent seal
- Due to parallel drop-down no trailing on the floor
- Automatic compensation at inclined floors
- High-grade silicone lip, simple lift height adjustment
- Can be shortened up to the next shorter length on stock
- 7 years warranty

## Versions / options

- Planet KG-S narrow → RD ≦ 48 dB, smoke-shielding
- Planet KG-S narrow → FH+RD ≦ 48 dB, fire-retardant + smoke-shielding
- Option bevel lip ≦ 44 dB, up to ↓ 20 mm, for uneven floors
- Special versions on request



## Surfaces

- Protection profile silver anodised EV1
- Protection profile stainless steel satin anodised

## Door types with Planet KG-S narrow



## More functions



## Technical specifications

Profile material	aluminum, → 11,5x38 mm, silver anodised EV1 or stainless steel satin anodised
Seal profile	high-grade silicone or high-grade self-extinguishing silicone
Seal height	up to ↓ 16 mm
Sound absorption value	up to ≦ 48 dB at 7 mm space to the floor; up to ≦ 47 dB at 14 mm space to the floor
Lift height adjustment	on the release knob with an Allen key 3 mm
Lengths in stock	459, 584, 709, 834, 959, 1084, 1209, 1334, 1459 mm
Special lengths	on request up to 6000 mm, sliding doors up to 1600 mm
Release	unilaterally on hinge side
Can be shortened	up to the maximum of 125 mm
Fastening	to be pasted
Frame protector plate	stainless, hammer fixed, 20x20 mm
Test approvals	on request

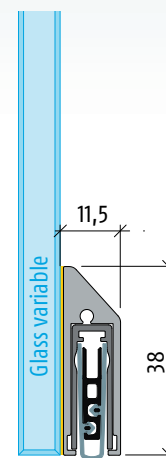

Seal height up to 16 mm



B ——— W

available in North America through Bridgeport Worldwide and its dealers  
T +1-800-362-1484 — planet.info@BridgeportWorldwide.com

Planet  
ASSA ABLOY



Planet KG-S narrow, pasted laterally on glass door, release side



Planet KG-S narrow, black C35 satin anodised

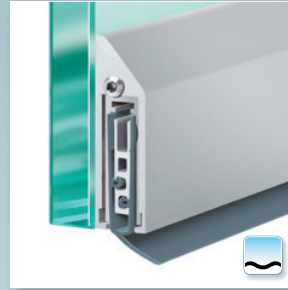

**Option:** Planet KG-S narrow, bevel lip for **uneven floors**



Planet KG-S narrow, with screw for Quick install



**Option:** Planet KG-S narrow, laterally pasted on **wooden door**



**Option:** Planet KG-S narrow, laterally pasted on **metal door**



**Option:** Planet KG-S narrow, laterally pasted on **PVC door**

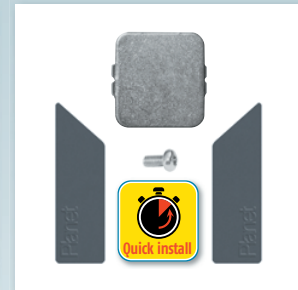

**Accessories:** Planet frame protector, screw for fixing the seal and set of Planet cover plates

## Order specifications

Planet KG-S narrow → RD ≤ 48 dB → silver anodised EV1 incl. set of cover plates and frame protector plate, type 1	Prod. code 38xxx-Ss*
Planet KG-S narrow → FH+RD ≤ 48 dB → silver anodised EV1 incl. set of cover plates and frame protector plate, type 1	Prod. code 39xxx-Ss*
Planet KG-S narrow → RD ≤ 48 dB → stainless steel satin anodised incl. set of cover plates and frame protector plate, type 1	Prod. code 38xxx-SXs*
Planet KG-S narrow → FH+RD ≤ 48 dB → stainless steel satin anodised incl. set of cover plates and frame protector plate, type 1	Prod. code 39xxx-SXs*

\* xxx = refer to price list for profile length

## Accessories | Options

Planet frame protector plate type 1 (stainless); possible type 2/3/4/5 → refer to chapter Accessories   Options	Prod. code 900014
Cut the Planet to fix dimension	Prod. code 900225
Set of Planet cover plates für KG-S / F8 narrow	Prod. code 900836
Adhesive tape set for Planet KG-S narrow	Prod. code 900837
Sliding door	Prod. code 900908
Bevel lip (≤ 44 dB, up to ↓ 20 mm) DIN L or DIN R	refer to price list, options / supplements



**Quick install:** with the screw you can fix the seal in no time and the door is immediately ready to use!

## Advertising text



Planet KG-S narrow → RD (smoke-shielding) ≤ 48 dB

Automatic door drop-down seal **Planet KG-S narrow → RD ≤ 48 dB**, unilateral release with parallel drop-down and automatic compensation at inclined floor, protection profile silver anodised EV1 or stainless steel satin anodised, pasted laterally on glass door. Seal height up to ↓ 16 mm. Lip from silicone. Protection profile and profile made from aluminum → **11,5 x 38 mm**, incl. cover plate on lock side for single leaf doors.

## Advertising text



Planet KG-S narrow → FH+RD (fire-retardant + smoke-shielding) ≤ 48 dB

Automatic door drop-down seal **Planet KG-S narrow → FH+RD ≤ 48 dB**, unilateral release with parallel drop-down and automatic compensation at inclined floor, protection profile silver anodised EV1 or stainless steel satin anodised, pasted laterally on glass door. Seal height up to ↓ 16 mm. Self-extinguishing silicone lip. Protection profile and profile made from aluminum → **11,5 x 38 mm**, incl. cover plate on lock side for single leaf doors.

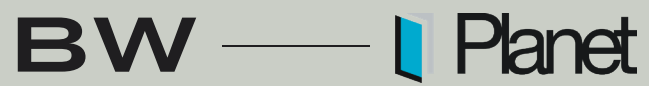

## KEEPING MAKERS MAKING

contact Bridgeport Worldwide to push your demountable partition system to the next level

T :+1-800-362-1484 x38 — [planet.info@BridgeportWorldwide.com](mailto:planet.info@BridgeportWorldwide.com)