



TECHNICAL GUIDE

DENSDECK® ROOF BOARDS

TABLE OF CONTENTS

02 Product
Overview

03 Architectural
Specifications

04 Standards and
Classifications

13 Roof System
Applications

16 Physical
Properties

18 Recommendations
and Limitations for
Use

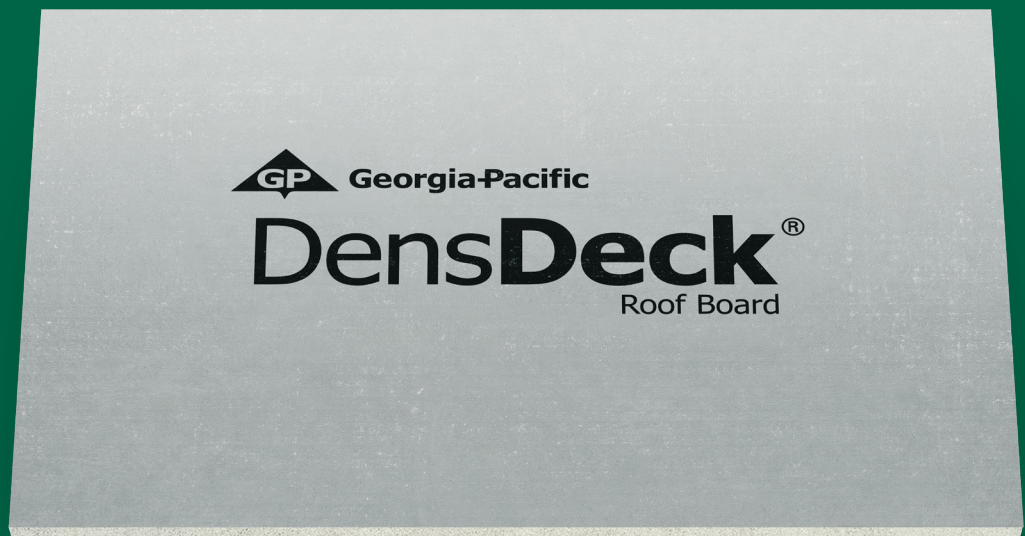

PRODUCTS



PRODUCT OVERVIEW

Over 30 Years of DensDeck® Roof Boards – Proven Performance

With billions of square feet installed in a complete range of roofing systems and climate extremes, DensDeck® Roof Boards have proven their toughness and versatility. The unique construction has been shown to withstand delamination, deterioration, warping and jobsite damage far more effectively than paper-faced gypsum board and other roofing products, such as wood fiberboard and perlite.

- Provides superior fire protection
- Resists fire and hail damage
- Holds up well under normal construction and maintenance foot traffic while stiffening and stabilizing roof decks
- Easy to install in all types of roof systems
- Ideal product for direct membrane application
- Tested within roofing systems for sound isolation

DensDeck® Roof Board is designed to address persistent challenges inherent in commercial roofing assemblies, such as fire resistance, strength and dimensional stability, when installed in a properly designed roof assembly. It is a fiberglass mat-faced, noncombustible (as described and tested in accordance with ASTM E136), nonstructural, gypsum core panel, and is recommended for mechanically attached membrane systems.

DensDeck® Prime Roof Board provides enhanced performance and is recommended for mechanically attached, adhered and partially adhered roofing systems, providing an ideal bonding surface for roofing membranes as well as air/vapor retarders. Building on our 30-year history of market-driven innovation, DensDeck® Prime Roof Board has now been enhanced with EONIC™ Technology, a patented system that delivers advanced moisture performance and mat-to-core bond strength.

With this advancement, DensDeck® Prime Roof Board is the first roof board with manufacturing specifications that include max 5%¹ total water absorption by weight and 1-gram² surface water absorption on both the face and the back of the board.³ Another critical benefit of EONIC™ Technology includes improved mat-to-core bond strength, which in third-party testing⁴ averaged 23% stronger on the face and 192% stronger on the back when compared to DensDeck® Prime Roof Board before the enhancement.

DensDeck® Prime Roof Board continues to provide a broader compatibility and higher performance with roofing adhesives. Its face mat allows adhesives to be applied more uniformly and consistently, and results in a stronger bond with the membrane. And for fully adhered and self-adhered “peel & stick” roofing systems, as well as hot-mopped, cold-mastic and torch-applied modified bitumen roofs, it provides a stronger, more economical installation by reducing the amount of mastic or adhesive, and potentially eliminating the field primer. Consult with membrane manufacturer for actual priming requirements.

DensDeck® StormX™ Prime Roof Board provides a higher level of performance and is recommended for mechanically attached, adhered and partially adhered roofing systems. Like DensDeck® Prime Roof Board, it is produced with patented EONIC™ Technology for enhanced strength/moisture resistance. DensDeck® StormX™ Prime Roof Board is FM-classified for Very Severe Hail (VSH) in approved single-ply membrane assemblies (consult RoofNav®, FM’s tool for roofing professionals, for specific assemblies). It was the first gypsum cover board to pass FM VSH in a single-ply assembly, and this assembly used an adhered standard 60 mil TPO bareback membrane.

1/2 in. and 5/8 in. DensDeck® Prime Roof Board, and 5/8 in. DensDeck® StormX™ Prime Roof Board are the first and only gypsum roof boards with a limited warranty for up to 90 days of exposure to normal weather conditions when applied on vertical parapet walls.*

Georgia-Pacific Building Products and Sustainability

Georgia-Pacific Building Products’ definition of sustainability is meeting the needs of society today without jeopardizing our ability to do so in the future. We are committed to using resources efficiently to provide innovative products and solutions that meet the needs of customers and society while operating in a manner that is environmentally and socially responsible, and economically sound.

¹Maximum value, per ASTM C1177, section 20

²Nominal value, per ASTM C1177, section 21

³Based on published manufacturing specifications as of June 1, 2020

⁴Comparison based on third-party testing conducted by PRI Construction Materials Technologies in October 2017. 1/2 in. boards tested in accordance to ASTM C209

*For complete warranty details, visit [DensDeck.com](https://www.densdeck.com).

ARCHITECTURAL SPECIFICATIONS

Georgia-Pacific Building Products' 3-part guide specifications are downloadable, as rewritable Microsoft® Word documents, in both CSI and ARCOM MasterSpec® formats. Georgia-Pacific Building Products' specifications and 3-D Revit®-compatible models can be found at buildgp.com/gypsum. Downloadable specifications are also available online from Building Systems Design, Inc., at bsdspeclink.com, and ARCOM Product MasterSpec at masterspec.com.

Code Compliance

DensDeck® Roof Boards are manufactured to meet ASTM C1177, conform with IBC sections 1505 and 1508, and have the following approvals:

- Florida Product Approved
- Miami-Dade County Product Control Approved

STANDARDS AND CLASSIFICATIONS

Standards and Classifications – Fire Resistance

DensDeck® Roof Board, DensDeck® Prime Roof Board and DensDeck® StormX™ Prime Roof Board are excellent fire barriers over combustible and noncombustible roof decks, including steel decks. Roofing specifications for steel deck installations often require a fire barrier as the component applied above the metal to help control and limit the amount of fuel contributed to a fire beneath the roof.

UL Fire Resistance Ratings. 5/8 in. (15.9 mm) DensDeck® Roof Boards are UL-classified; designated as Type DD by UL LLC; included in assembly designs investigated by UL for hourly fire resistance ratings; and may also replace any unclassified 5/8 in. (15.9 mm) gypsum board in an assembly in the UL Fire Resistance Directory under the prefix “P.”

UL 790 Classification. DensDeck® Roof Board, DensDeck® Prime Roof Board and DensDeck® StormX™ Prime Roof Board have been certified by UL for use as a fire barrier over combustible and noncombustible decks in accordance with the ANSI/UL 790 and ULC CAN-S114 test standard. The UL classification includes a comprehensive Class A, B or C rating. This test method and resulting classification measures the external fire resistance of the roof system but does not include an investigation of fire resistance to internal sources directed at the underside of the roof system. For additional information concerning the UL 790 classification for DensDeck® Roof Boards, consult the UL certifications directory under categories TGFU.R15206 (Roofing Systems) and TGFU7.R15206 (Roofing Systems Certified for Canada).

UL 1256 Classification. DensDeck® Roof Board and DensDeck® Prime Roof Board have also been certified by UL in roof deck constructions for internal (under deck) fire exposure in accordance with the ANSI/UL 1256 Steiner Tunnel test. The UL listing includes the use of 1/4 in. (6.4 mm) DensDeck® Roof Boards under foam plastic insulation. For additional information concerning the UL 1256 classification, consult the UL certifications directory under categories TGKX (Roof Deck Constructions), TIAR (Building Units) and TIAR7 (Building Units Certified for Canada).

FM Class 1 Approvals. 1/4 in. (6.4 mm) DensDeck® Roof Boards have passed testing under the FM Calorimeter Standard 4450 (Approval Standard for Class 1 Insulated Steel Deck Roofs) and have been approved by FM for insulated steel deck roofs when installed per FM guidelines. To achieve a Class 1 designation, the assembly must satisfy criteria for fire, wind uplift, foot traffic and hail damage resistance. For more information about FM Approvals and Class 1 assemblies, consult FM or RoofNav®. Please note, however, that the performance of a roof depends on all components used in the roofing assembly and how the components interact.

ASTM C1177. 5/8 in. (15.9 mm) DensDeck® Roof Board, 5/8 in. (15.9 mm) DensDeck® Prime Roof Board, and 5/8 in. (15.9 mm) DensDeck® StormX™ Prime Roof Board are manufactured to meet the “Type X” requirements of ASTM C1177 for increased fire resistance beyond regular gypsum board.

See: *January 2006 NRCA/MRCA Technical Bulletin: Fire Testing of Membrane Roof Systems.*

Flame Spread and Smoke Development. When tested in accordance with ASTM E84, UL723 and ULC CAN-S102, DensDeck® Roof Board and DensDeck® Prime Roof Board had Flame Spread 0, Smoke Developed 0.

Long-term fire protection of roofing systems is a key concern of the design authority, code officials and building owners. DensDeck® Roof Boards will contribute to the fire-resistant characteristics of roof assemblies over time.

“When using a low-slope membrane roof system, designers should include in their designs a suitable cover board that is consistent with an appropriate listing or approval from a code-approved testing agency. This recommendation is consistent with the guidelines already contained in The NRCA Roofing and Waterproofing Manual, Fifth Edition. Furthermore, for mechanically attached single-ply membrane roof systems, designers of newly installed roof systems are now recommended to include a noncombustible cover board that is consistent with an appropriate listing or approval from a code-approved testing agency. Examples of noncombustible cover boards include fiberglass mat-faced gypsum boards and gypsum roof boards.” (January 2006 NRCA/MRCA Technical Bulletin.)

For complete warranty details, visit DensDeck.com.

STANDARDS AND CLASSIFICATIONS

The design assemblies in this guide are presented for illustrative purposes only. It is important that you consult a design professional and the appropriate fire resistance directory or test report for complete assembly and related information. Georgia-Pacific Building Products does not provide architectural, engineering or roofing system services. For additional fire safety information concerning Georgia-Pacific Building Products, visit buildgp.com/safetyinfo.

UL Classifications

The following are typical configurations with DensDeck® Roof Boards certified by UL for use as a fire barrier over combustible and noncombustible decks, and are for illustration purposes only. Please consult UL for additional information.

Typical UL Fire Barrier Board Classification on Noncombustible Decking

- A. UL classified roof covering
- B. Minimum 1/4 in. (6.4 mm) DensDeck® Prime Roof Board
- C. UL classified insulation
- D. Minimum 1/4 in. (6.4 mm) any DensDeck® Roof Board serving as an insulation thermal barrier underlayment and an acceptable code alternative to a thermal barrier
- E. Classified steel deck

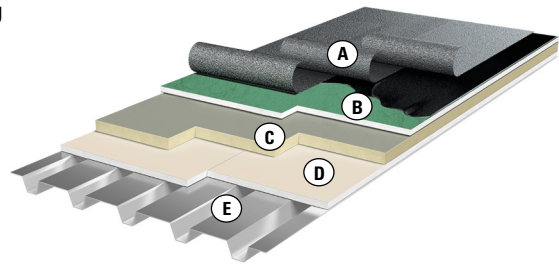

Typical UL Fire Barrier Board Classification on Combustible Decking*

- A. UL classified roof covering
- B. Minimum 1/4 in. (6.4 mm) DensDeck® Prime Roof Board
- C. UL classified insulation (optional)
- D. Minimum 1/4 in. (6.4 mm) any DensDeck® Roof Board serving as an insulation thermal barrier overlayment with all joints staggered a minimum of 6 in. (152 mm) from the plywood joints
- E. Classified wood deck

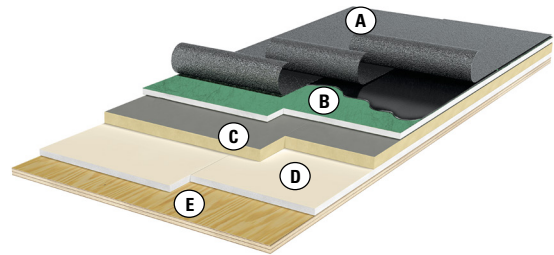

*The UL 790 classification for DensDeck® Roof Boards provides that the use of DensDeck® Roof Boards as a barrier board over a combustible deck permits the use of any classified roofing system which would otherwise be limited to use over a noncombustible deck. When used, the insulation must consist of one of the types specified. For additional information, consult the UL certifications directory under category TGFU (Roofing Systems).

STANDARDS AND CLASSIFICATIONS

FM Approvals

DensDeck® Roof Boards are often utilized in these constructions as an insulation underlayment (thermal barrier) or substrate for air or vapor retarders. In most assemblies, the board will be used as an insulation overlayment (membrane underlayment) or cover board (1/4 in. (6.4 mm), 1/2 in. (12.7 mm) or 5/8 in. (15.9 mm)). In other assemblies, it will serve both of these roles in the same system.

The following are typical configurations of a roof deck for an FM Class 1 fire rating and an FM Very Severe Hail (VSH) classified system, and are for illustration purposes only. Please consult FM or RoofNav.com for additional information.

Typical Configuration of DensDeck® Roof Boards (Class 1 Fire Rating)

- A. Membrane (various)
- B. Minimum 1/4 in. (6.4 mm) of any DensDeck® Roof Board overlayment (cover board)
- C. Rigid foam insulation
- D. Minimum 1/4 in. (6.4 mm) of any DensDeck® Roof Board underlayment (thermal barrier)
- E. Metal deck

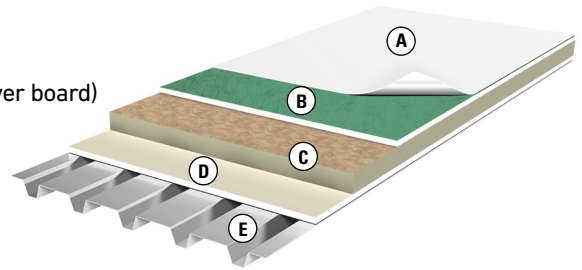

Typical Configuration of DensDeck® StormX™ Prime Roof Board (VSH Classified)

- A. Membrane
- B. Minimum 5/8 in. (15.9 mm) DensDeck® StormX™ Prime Roof Board placed directly below the roofing membrane. In this application, the product provides the primary support for the roofing membrane and protects insulation.
- C. Rigid foam insulation
- D. Any structural deck

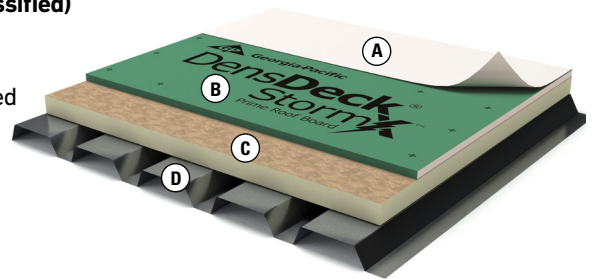

System Components, Standards and Classifications – Wind-Uplift Resistance

Wind Uplift Information

Wind-uplift resistance of roofing assemblies is achieved by fastening and/or adhering the roofing components to the structural deck. Uplift-resistance testing may be conducted by several independent laboratories, in accordance with FM 4470 and ANSI/UL 1897 test procedures. The test results show the tested (not design) pounds per square foot (PSF) uplift resistance which has been achieved.

It is the responsibility of the roofing design authority to comply with code requirements and follow the guidelines in ASCE-7 or FM 1-28 and 1-29 to establish the appropriate uplift-resistance design and safety factor. Several factors are considered to determine the design pressure required, including but not limited to height of the building, ground roughness, exposure and importance factor. Once the design pressure is determined, the roofing assembly which meets this pressure, with the appropriate safety factor, is selected by the design authority.

STANDARDS AND CLASSIFICATIONS

Sample Wind-Uplift-Resistant Assemblies

The following are typical roofing systems with examples of assemblies evaluated by FM, UL or other labs for wind-uplift resistance. These systems are presented for illustration only, and the examples of wind-uplift resistance are for the entire assembly tested, not just the DensDeck® Roof Boards. **Actual results may vary depending on moisture (see page 18) and other factors. Georgia-Pacific Building Products makes no representations or warranties concerning the vertical pull or uplift resistance of any roof assembly or system.**

(Check membrane manufacturers' listing, including FM, UL and other accredited labs, for thousands of additional uplift-assembly ratings with DensDeck® Roof Boards.)

Fastener rates shown are for the field of the roof. Additional fasteners are required for perimeter and corner areas and require either additional designer authority calculations or uplift testing. Unless otherwise noted, all screws used in tests are polymer coated, FM approved and minimum 12-gauge steel, and plates are 3 in. (76 mm) diameter corrosion-resistant steel. Tests were conducted over 22-gauge steel decks. For fastener requirements in wood or structural concrete decks, refer to FM Global Property Loss Prevention Data Sheet 1-29.

| System Type and Description | Wind-uplift PSF | Product | # of fasteners (4 ft. x 8 ft. board) |
|---------------------------------|-----------------|---|--------------------------------------|
| Vapor Retarder Substrate | FM 1-90 | 5/8 in. (15.9 mm) DensDeck® Roof Board | 8 |
| | FM 1-90 | 5/8 in. (15.9 mm) DensDeck® Prime Roof Board or DensDeck® StormX™ Prime Roof Board | 8 |

A. Any rated adhered membrane

B. Minimum 1/4 in. (6.4 mm) any DensDeck® Roof Board (optional)

C. Insulation (optional)

D. Vapor retarder

E. Minimum 5/8 in. (15.9 mm) any DensDeck® Roof Board

F. Classified steel deck

G. Fastener (see chart)

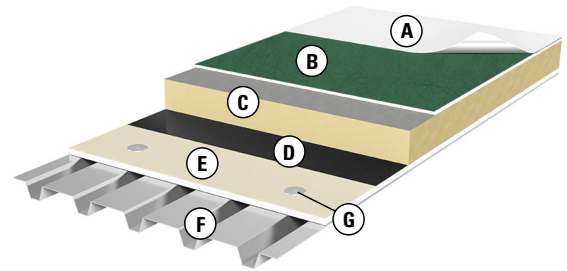

Components above vapor retarder bonded with cold mastics, hot asphalt or adhesives.

| System Type and Description | Wind-uplift PSF | Product | # of fasteners (4 ft. x 8 ft. board) |
|---|---|---|--------------------------------------|
| Fully Adhered EPDM and Thermoplastic Membranes | FM 1-90 | 1/4 in. (6.4 mm) DensDeck® Prime Roof Board | 12 |
| | FM 1-90 | 1/2 in. (12.7 mm) DensDeck® Prime Roof Board | 8 |
| | FM 1-90 | 5/8 in. (15.9 mm) DensDeck® Prime Roof Board | 8 |
| | FM 1-105 | 1/4 in. (6.4 mm) DensDeck® Prime Roof Board | 18 |
| | FM 1-135 | 1/2 in. (12.7 mm) DensDeck® Prime Roof Board | 18 |
| | FM 1-150 | 1/2 in. (12.7 mm) DensDeck® Prime Roof Board | 20 |
| | FM 1-180 | 5/8 in. (15.9 mm) DensDeck® Prime Roof Board | 24 |
| FM 1-285 | 1/2 in. (12.7 mm) DensDeck® Prime Roof Board | 32 | |

A. Single-ply membrane

B. Minimum 1/4 in. (6.4 mm) DensDeck® Prime Roof Board

C. Insulation

D. Minimum 1/4 in. (6.4 mm) any DensDeck® Roof Board (optional)

E. Classified steel deck

F. Fastener (see chart)

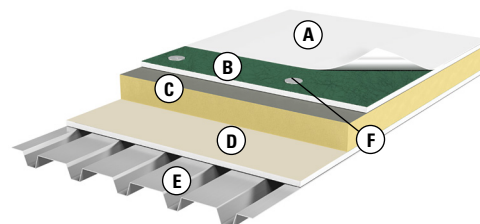

Single-ply and EPDM will include both reinforced and nonreinforced.

STANDARDS AND CLASSIFICATIONS

| System Type and Description | Wind-uplift PSF | Product | # of fasteners (4 ft. x 8 ft. board) |
|--|-----------------|---|--------------------------------------|
| Modified Bitumen/BUR | FM 1-90 | 1/4 in. (6.4 mm) DensDeck® Prime Roof Board | 8 |
| A. BUR or mod bit membrane | FM 1-90 | 1/2 in. (12.7 mm) DensDeck® Prime Roof Board | 8 |
| B. Minimum 1/4 in. (6.4 mm) DensDeck® Prime Roof Board | FM 1-90 | 5/8 in. (15.9 mm) DensDeck® Prime Roof Board | 8 |
| C. Insulation | FM 1-135 | 1/2 in. (12.7 mm) DensDeck® Prime Roof Board | 20 |
| D. Minimum 1/4 in. (6.4 mm) any DensDeck® Roof Board (optional) | FM 1-225 | 1/2 in. (12.7 mm) DensDeck® Prime Roof Board | 24 |
| E. Classified steel deck | FM 1-315 | 1/2 in. (12.7 mm) DensDeck® Prime Roof Board | 32 |
| F. Fastener (see chart) | UL 150 PSF | 1/2 in. (12.7 mm) DensDeck® Prime Roof Board | 16 |
| | UL 195 PSF | 5/8 in. (15.9 mm) DensDeck® Prime Roof Board | 16 |
| | UL 240 PSF | 5/8 in. (15.9 mm) DensDeck® Prime Roof Board | 20 |

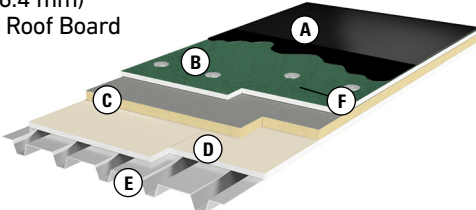

Modified bitumen without base sheet. Mod bit is torched or set in hot asphalt. BUR is minimum 3-ply.

| System Type and Description | Wind-uplift PSF | Product | # of fasteners (4 ft. x 8 ft. board) |
|--|---|---|--------------------------------------|
| EPDM, BUR or Mod Bit with Insulation Adhered with Hot Asphalt | FM 1-60 (EPDM) | 1/2 in. (12.7 mm) or 5/8 in. (15.9 mm) DensDeck® Roof Board or DensDeck® Prime Roof Board | 8 |
| A. EPDM, BUR or mod bit membrane | DensDeck® Roof Board and DensDeck® Prime Roof Board (1/2 in. (12.7 mm) or 5/8 in. (15.9 mm)) and fully adhered single-ply membranes FM-rated 60 PSF with insulation attached with asphalt adhesive. | | |
| B. Minimum 1/4 in. (6.4 mm) DensDeck® Prime Roof Board (optional) | | | |
| C. Rigid foam insulation | | | |
| D. Asphalt adhesive | | | |
| E. Minimum 1/2 in. (12.7 mm) any DensDeck® Roof Board (optional) | 1-90 (BUR or Mod Bit) | 1/2 in. (12.7 mm) or 5/8 in. (15.9 mm) DensDeck® Roof Board or DensDeck® Prime Roof Board | 8 |
| F. Classified steel deck | DensDeck® Roof Board and DensDeck® Prime Roof Board (1/2 in. (12.7 mm) or 5/8 in. (15.9 mm)) and BUR or modified bitumen membranes FM-rated 90 PSF with insulation attached with asphalt adhesive. | | |
| G. Fastener (see chart) | | | |

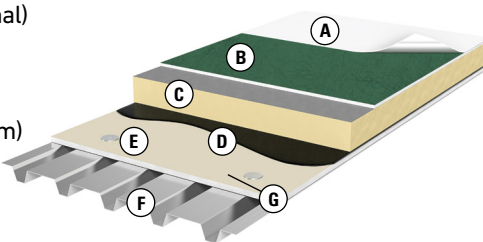

STANDARDS AND CLASSIFICATIONS

GP Fastener Patterns

Other patterns are available from system manufacturers or testing agencies.

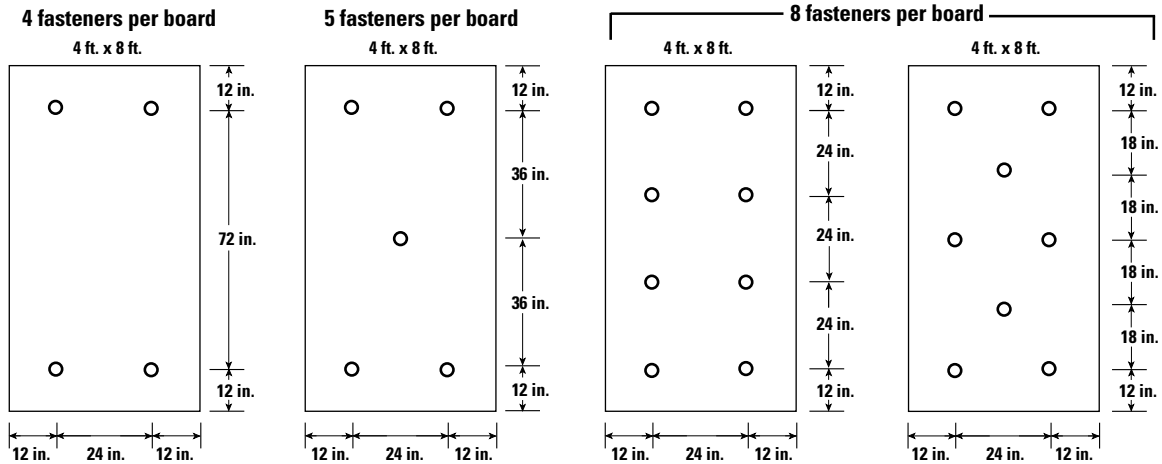

Note: Preliminary insulation or mechanically attached roof covering requires a minimum of 4 fasteners per 4 ft. x 8 ft. board in FM assemblies.

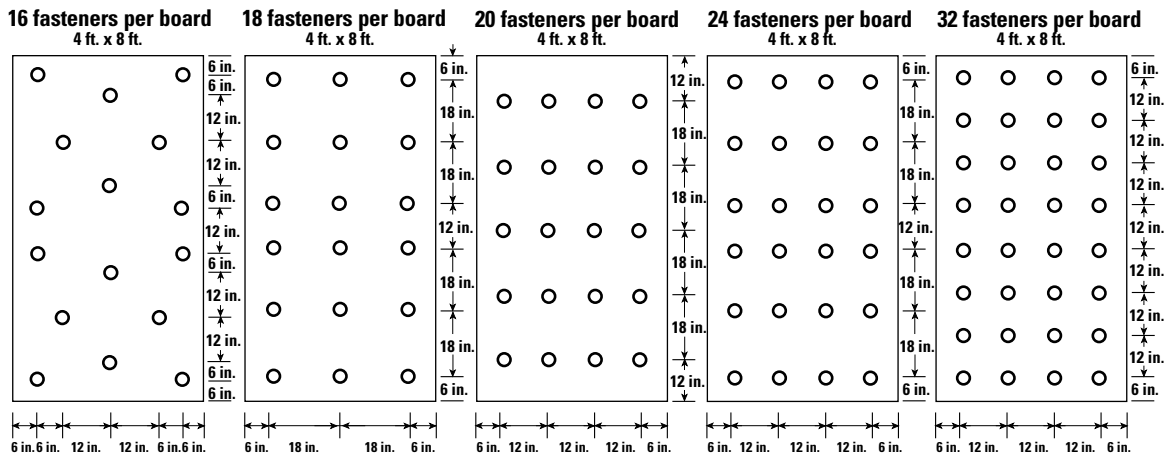
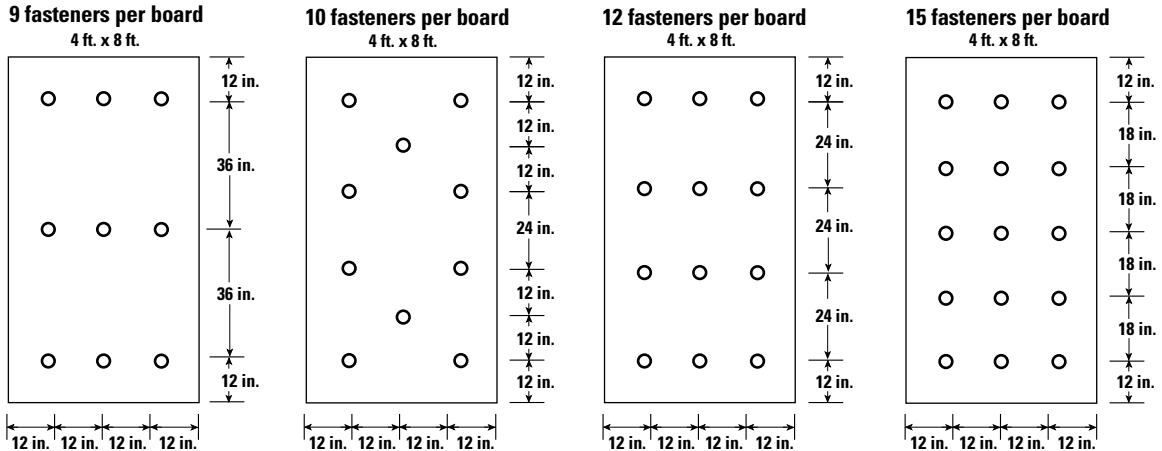

SOUND CONTROL ILLUSTRATIONS

What Is Sound Control?

To block unwanted entry of sound through a roof assembly, multiple layers of DensDeck® Roof Boards will help efficiently keep outside sound outside. Whether around airports, in urban environments or to keep equipment noise from disrupting the occupants of a building, DensDeck® Roof Boards can effectively contribute to sound isolation.

Sound Transmission Class (STC), measured in decibels, is the weighted average of the drop in sound intensity measured in a range of frequencies from 80 to 4,000 Hz across a barrier. The sound level outside is reduced by the STC number and if the result is close to or below the background, interior sound level, it will not be heard or will not be disruptive.

An Outdoor Indoor Transmission Class (OITC) rating is a single number calculated in accordance with standard ASTM E1332 using the Transmission Loss measured at 18 one-third octave bands from 80 Hz to 4000 Hz. The rating is most appropriate for comparing the performance of exterior facade elements, including roofs exposed to typical transportation noise sources.

**Sound Isolation Example
(assembly 9)
65 dB Sound Source**

- A. Membrane
- B. 5/8 in. (15.9 mm) DensDeck® Roof Boards
- C. 2 x 2 in. (51 mm) Foam insulation
- D. Steel deck

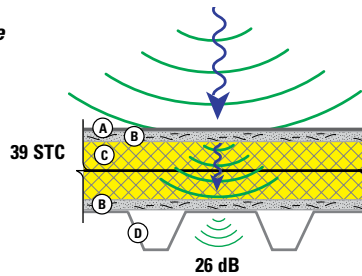

| Sound Source | Decibels |
|----------------------------|----------|
| Jet take-off, rock concert | 120 |
| Chainsaw | 110 |
| Lawn mower, truck, tractor | 90 |
| Freeway traffic | 70 |
| Office (background) | 40-50 |

The following table summarizes results from sound testing conducted on steel and wood deck assemblies with DensDeck® Prime Roof Boards. The tests were conducted in 2019 at Intertek in York, PA, and the specimens were evaluated in accordance with the following: ASTM E90-09 (2016), ASTM E413-16, ASTM E1332-16, and ASTM E2235-04 (2012). The results are based on characteristics, properties and performance of materials and systems obtained under controlled test conditions. Actual results may vary and Georgia-Pacific makes no representations or warranties concerning the STC rating of any assembly.

STC Testing of Steel and Wood Deck Roof Assemblies

| | STC | OITC | Rw | Underlayment | Insulation | Cover Board | Membrane | System Attachment | Decking |
|----|-----|------|----|--|--------------------------------------|--|----------|-----------------------|-----------------------|
| 1 | 23 | 20 | 23 | None | 4 in. polyiso | None | None | Mechanical | 22 Gauge Type B Steel |
| 2 | 28 | 25 | 28 | 5/8 in. (15.9 mm) DensDeck® Prime Roof Board | 4 in. polyiso | None | None | Mechanical | 22 Gauge Type B Steel |
| 3 | 29 | 24 | 29 | None | 4 in. polyiso | 1/4 in. (6.4 mm) DensDeck® Prime Roof Board | None | Mechanical | 22 Gauge Type B Steel |
| 4 | 30 | 25 | 30 | None | 4 in. polyiso | 1/2 in. (12.7 mm) DensDeck® Prime Roof Board | None | Mechanical | 22 Gauge Type B Steel |
| 5 | 31 | 26 | 31 | None | 4 in. polyiso | 5/8 in. (15.9 mm) DensDeck® Prime Roof Board | None | Mechanical | 22 Gauge Type B Steel |
| 6 | 34 | 28 | 34 | None | 4 in. polyiso | 5/8 in. (15.9 mm) DensDeck® Prime Roof Board | None | Mechanical or Adhered | Wood - OSB |
| 7 | 33 | 27 | 33 | 5/8 in. (15.9 mm) DensDeck® Prime Roof Board | 4 in. polyiso | 5/8 in. (15.9 mm) DensDeck® Prime Roof Board | None | Adhered | 22 Gauge Type B Steel |
| 8 | 35 | 28 | 35 | 5/8 in. (15.9 mm) DensDeck® Prime Roof Board | 4 in. polyiso | 5/8 in. (15.9 mm) DensDeck® Prime Roof Board | None | Mechanical | 22 Gauge Type B Steel |
| 9 | 38 | 31 | 38 | 5/8 in. (15.9 mm) DensDeck® Prime Roof Board | 4 in. polyiso | 5/8 in. (15.9 mm) DensDeck® Prime Roof Board | None | Mechanical or Adhered | Wood - OSB |
| 10 | 37 | 31 | 37 | Two (2) - 5/8 in. (15.9 mm) DensDeck® Prime Roof Board | 4 in. polyiso | 5/8 in. (15.9 mm) DensDeck® Prime Roof Board | None | Mechanical | 22 Gauge Type B Steel |
| 11 | 46 | 30 | 44 | 5/8 in. (15.9 mm) DensDeck® Prime Roof Board | 2.5 in. polyiso + 3 in. mineral wool | 5/8 in. (15.9 mm) DensDeck® Prime Roof Board | None | Adhered | 22 Gauge Type B Steel |
| 12 | 49 | 36 | 49 | Two (2) - 5/8 in. (15.9 mm) DensDeck® Prime Roof Board | 2.5 in. polyiso + 3 in. mineral wool | 5/8 in. (15.9 mm) DensDeck® Prime Roof Board | None | Mechanical or Adhered | 22 Gauge Type B Steel |
| 13 | 53 | 40 | 52 | Two (2) - 5/8 in. (15.9 mm) DensDeck® Prime Roof Board | 6 in. mineral wool + flute filler | 5/8 in. (15.9 mm) DensDeck® Prime Roof Board | None | Adhered | 22 Gauge Type B Steel |
| 14 | 55 | 43 | 55 | Two (2) - 5/8 in. (15.9 mm) DensDeck® Prime Roof Board | 6 in. mineral wool + flute filler | Two (2) - 5/8 in. (15.9 mm) DensDeck® Prime Roof Board | None | Adhered | 22 Gauge Type B Steel |
| 15 | 56 | | | 5/8 in. (15.9 mm) DensDeck® Prime Roof Board | 3 in. polyiso | 1/2 in. (12.7 mm) DensDeck® Prime Roof Board | None | Mechanical | 22 Gauge Type B Steel |

See website for more details and assembly drawings.

SOUND CONTROL ILLUSTRATIONS

Assemblies are presented for illustration only. It is important that you consult a design professional for assembly information. Georgia-Pacific Building Products does not provide architectural or engineering services.

STC 56/OITC 42

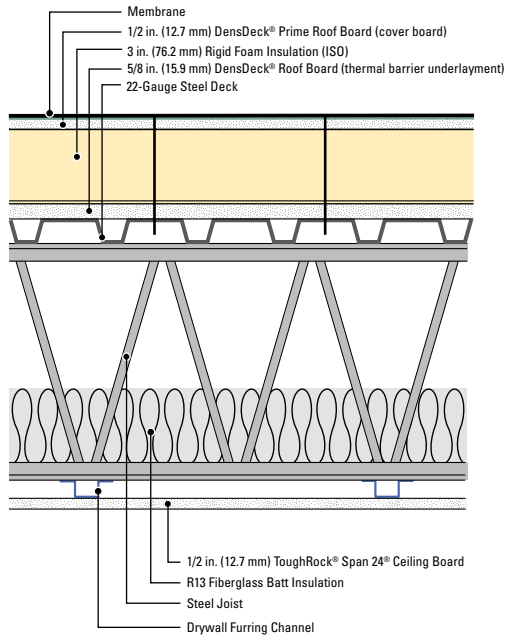

STC 57/OITC 43

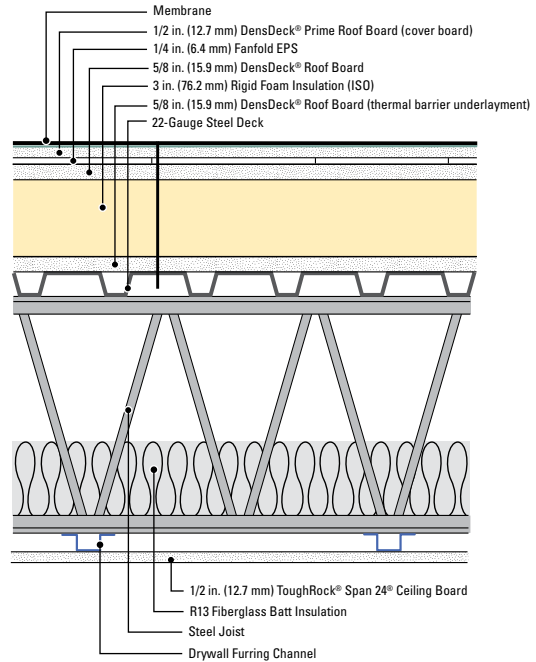

STC 56/OITC 41

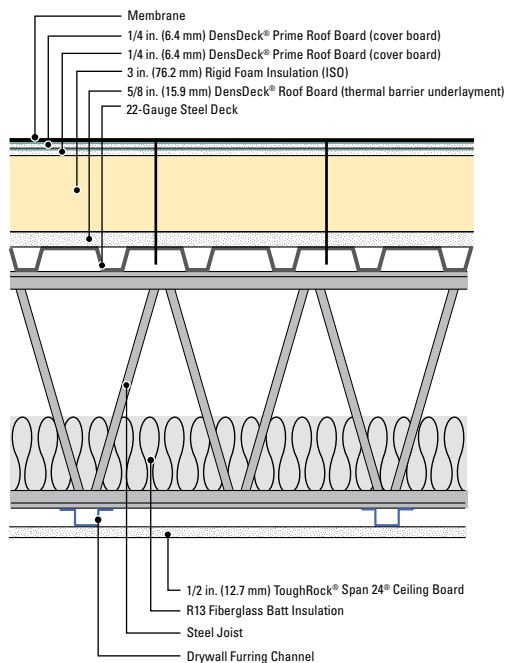

STC 58/OITC 43

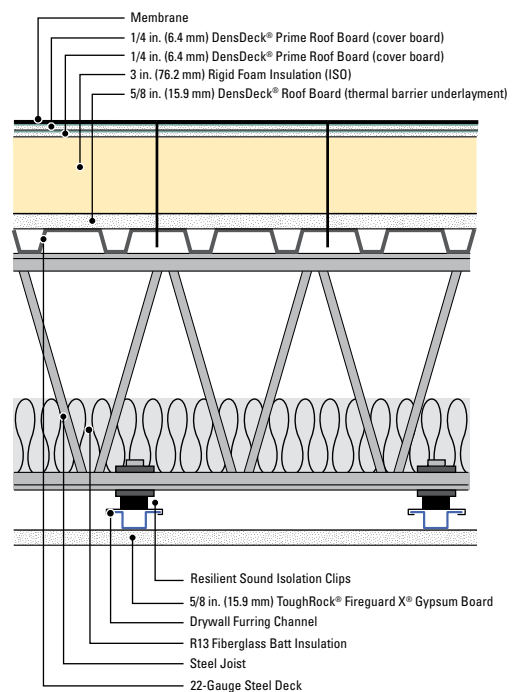

SOUND CONTROL ILLUSTRATIONS

STC 59/OITC 44

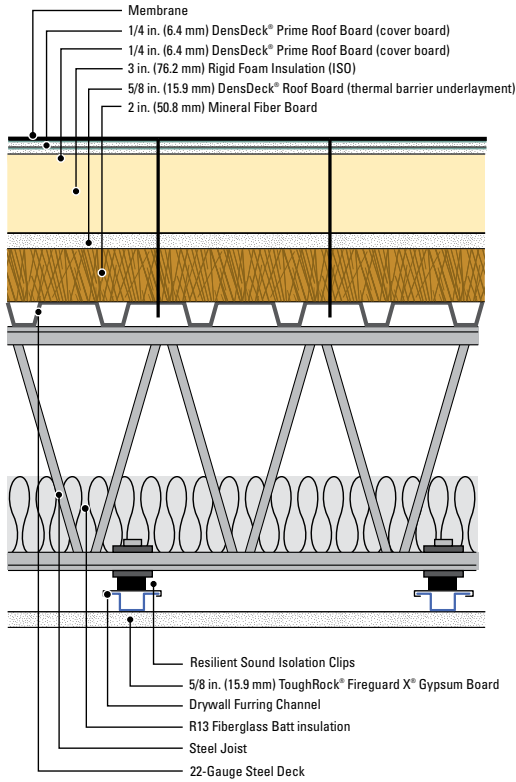

STC 61/OITC 49

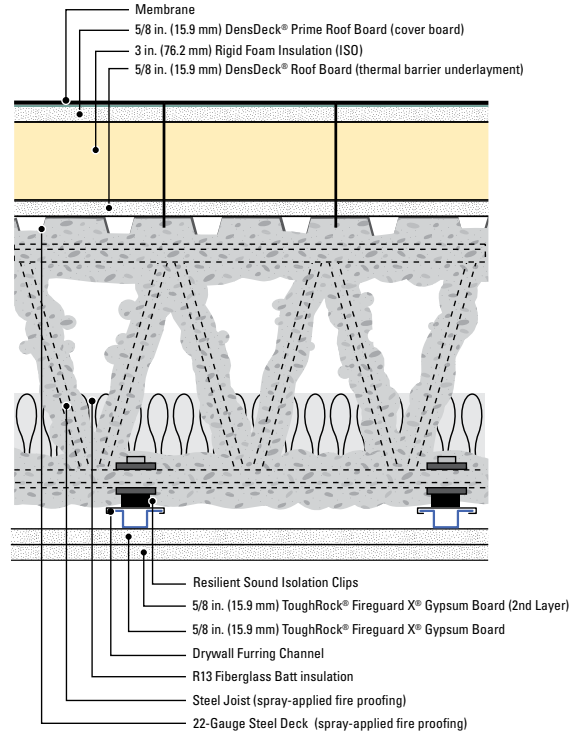

ROOF SYSTEM APPLICATIONS

The following are typical examples of roofing system applications with DensDeck® Roof Boards and are presented for illustration only. Please consult with the designer, system manufacturer or other design authority for use and installation of any application. Georgia-Pacific Building Products does not provide roofing design services and makes no warranties or representation with respect to any particular system or any components or materials other than DensDeck® Roof Boards. It is the responsibility of the system manufacturer or design authority to determine the suitability of DensDeck® Roof Boards, or the use of other materials with DensDeck® Roof Boards, for any particular application.

Cover Board – DensDeck® Prime Roof Board and DensDeck® StormX™ Prime Roof Board are preferred for adhered membrane. DensDeck® Roof Board is preferred for mechanically attached membrane.

- A. Membrane
- B. Minimum 1/4 in. (6.4 mm) any DensDeck® Roof Board placed directly below the roofing membrane. In this application, the product provides the primary support for the roofing membrane and protects insulation.
- C. Rigid foam insulation
- D. Any structural deck

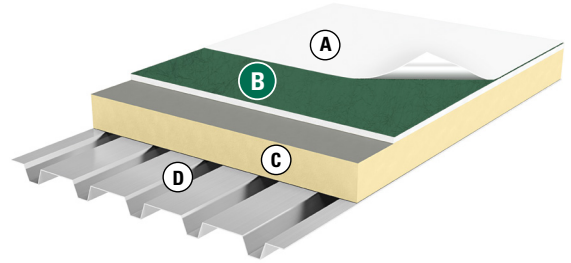

Substrate for Vapor Retarder – DensDeck® Prime Roof Board preferred.

- A. Membrane
- B. Minimum 1/4 in. (6.4 mm) any DensDeck® Roof Board fastened to deck. Membrane attached with cold mastics, hot asphalt or adhesives.
- C. Rigid foam insulation
- D. Vapor retarder
- E. Vapor retarder substrate
- F. Any structural deck

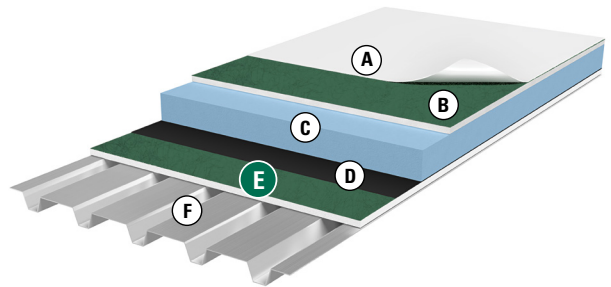

Metal Roof Thermal Barrier – DensDeck® Prime Roof Board preferred.

- A. Standing-seam metal roof
- B. Secondary water barrier
- C. Minimum 1/4 in. (6.4 mm) any DensDeck® Roof Boards provide a thermal barrier in conjunction with a standing-seam metal or tile roofing system while providing support for hail resistance and noise reduction.
- D. Insulation (optional)
- E. Metal deck

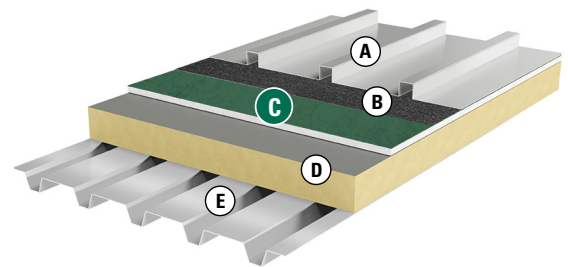

Roof Recovery Board – DensDeck® Prime Roof Board preferred for adhered systems.

- A. Membrane
- B. Minimum 1/4 in. (6.4 mm) any DensDeck® Roof Boards utilized as a roof recovery board. Recovery boards are placed over the existing membrane surface where they function as a separator and support layer between the old roof and a new roofing membrane.
- C. Existing roof assembly
- D. Any structural deck

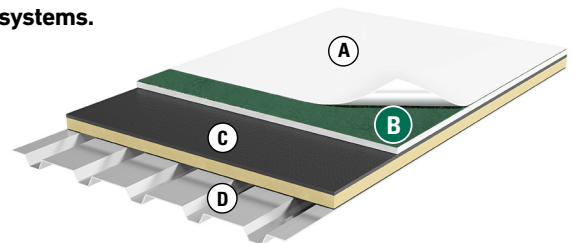

The highlighted green circles are intended to call attention to the recommended DensDeck® Roof Board for that particular application.

ROOF SYSTEM APPLICATIONS

Thermal Barrier – DensDeck® Roof Board or DensDeck® Prime Roof Board

- A. Membrane
- B. Minimum 1/4 in. (6.4 mm) DensDeck® Roof Board or DensDeck® Prime Roof Board
- C. Rigid foam insulation
- D. Minimum 1/4 in. (6.4 mm) DensDeck® Roof Board or DensDeck® Prime Roof Board provide a thermal barrier installed directly to metal deck for both expanded and extruded polystyrene insulation.
- E. Metal deck

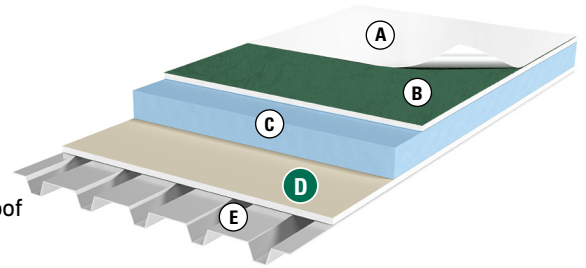

Typical Configuration of DensDeck® StormX™ Prime Roof Board (VSH Classified)

- A. Membrane
- B. Minimum 5/8 in. (15.9 mm) DensDeck® StormX™ Prime Roof Board placed directly below the roofing membrane. In this application, the product provides the primary support for the roofing membrane and protects insulation.
- C. Rigid foam insulation
- D. Any structural deck

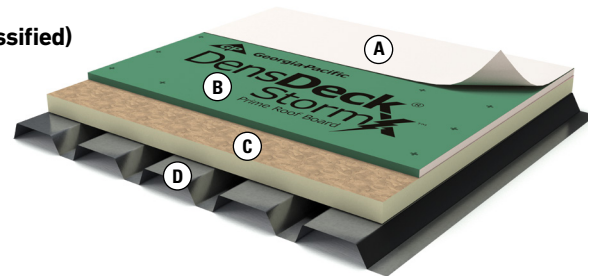

Wood Shake/Shingle Underlayment

- A. Wood shake/shingles
- B. Organic felt
- C. Minimum 1/4 in. (6.4 mm) any DensDeck® Roof Board as a wood shake/shingle underlayment on a combustible deck assembly to achieve a UL Class A fire rating
- D. Combustible deck

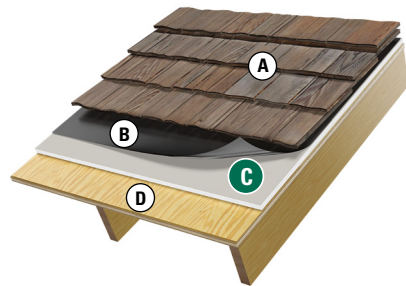

Vegetative “Green” Roof

- A. Growing medium and plants
- B. Moisture retention mat
- C. Drainage layer
- D. Protection fabric/root barrier
- E. Waterproofing membrane
- F. Minimum 1/2 in. (12.7 mm) DensDeck® Prime Roof Board
- G. Insulation
- H. Any structural deck

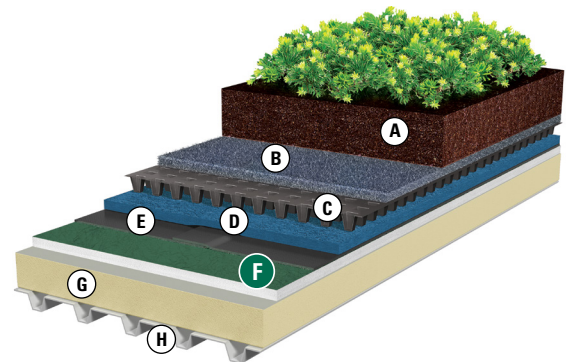

The highlighted green circles are intended to call attention to the recommended DensDeck® Roof Board for that particular application.

ROOF SYSTEM APPLICATIONS

Parapet Wall Substrate – DensDeck® Prime Roof Board preferred

- A. Coping
- B. Minimum 1/2 in. (12.7 mm) DensDeck® Prime Roof Board or
5/8 in. (15.9 mm) DensDeck® StormX™ Prime Roof Board
- C. Nailers
- D. Concrete masonry unit (CMU)
- E. Adhered flashing membrane
- F. Minimum 1/2 in. (12.7 mm) DensDeck® Prime Roof Board or
5/8 in. (15.9 mm) DensDeck® StormX™ Prime Roof Board
- G. DensDeck® Roof Board, DensDeck® Prime Roof Board or
DensDeck® StormX™ Prime Roof Board
- H. Rigid foam insulation
- I. Any structural deck

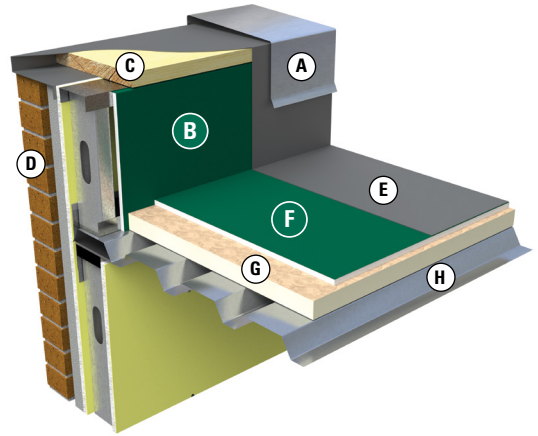

Photovoltaic Roofing System

- A. PV panels
- B. Roofing membrane
- C. Minimum 1/4 in. (6.4 mm) DensDeck® Prime Roof Board
- D. Insulation
- E. DensDeck® Prime Roof Board (optional)
- F. Any structural deck

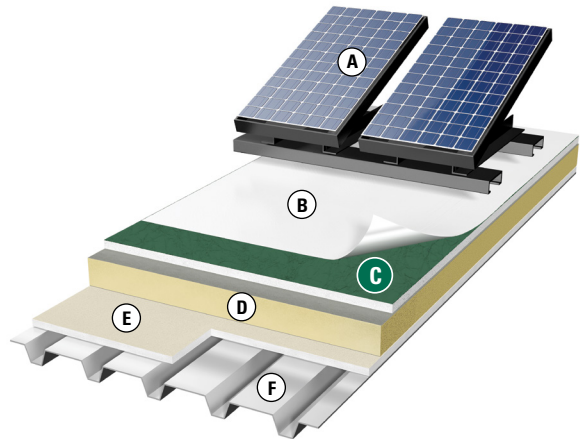

The highlighted green circles are intended to call attention to the recommended DensDeck® Roof Board for that particular application.

PHYSICAL PROPERTIES

DensDeck® Roof Board

| Properties | 1/4 in. (6.4 mm) | 1/2 in. (12.7 mm) | 5/8 in. (15.9 mm) |
|--|---|---|---|
| Thickness, nominal | 1/4 in. (6.4 mm) ± 1/16 in. (1.6 mm) | 1/2 in. (12.7 mm) ± 1/32 in. (0.8 mm) | 5/8 in. (15.9 mm) ± 1/32 in. (0.8 mm) |
| Width, standard | 4 ft. (1219 mm) ± 1/8 in. (3 mm) | 4 ft. (1219 mm) ± 1/8 in. (3 mm) | 4 ft. (1219 mm) ± 1/8 in. (3 mm) |
| Length, standard | 8 ft. (2438 mm) ± 1/4 in. (6.4 mm) | 8 ft. (2438 mm) ± 1/4 in. (6.4 mm) | 8 ft. (2438 mm) ± 1/4 in. (6.4 mm) |
| Weight, nominal, lbs./sq. ft. (kg/m ²) ¹ | 1.2 (5.9) | 2.0 (9.8) | 2.5 (12.2) |
| Surfacing | Fiberglass mat | Fiberglass mat | Fiberglass mat |
| Flexural Strength ² , parallel, lbf. minimum (N) | ≥40 (178) | ≥80 (356) | ≥100 (444) |
| Flute Spanability ³ | 2-5/8 in. (67 mm) | 5 in. (127 mm) | 8 in. (203 mm) |
| Permeance ⁴ , perms (ng/Pa•S•m ²) | >50 (>2850) | >35 (>1995) | >32 (>1824) |
| R Value ⁵ , ft ² •°F•hr/BTU (m ² •K/W)* | .28 | .56 | .67 |
| Linear Variation with Change in Temp., in/in/°F (mm/mm/°C) | 8.5x10 ⁻⁶ (15.3x10 ⁻⁶) | 8.5x10 ⁻⁶ (15.3x10 ⁻⁶) | 8.5x10 ⁻⁶ (15.3x10 ⁻⁶) |
| Linear Variation with Change in Moisture, mm/mm/% RH (in/in/% RH) | 6.25x10 ⁻⁶ | 6.25x10 ⁻⁶ | 6.25x10 ⁻⁶ |
| Water Absorption ⁶ , % max | 10.0 | 10.0 | 10.0 |
| Compressive Strength ⁷ , psi nominal (kPa)* | 900 (6205) | 900 (6205) | 900 (6205) |
| Surface Water Absorption, grams, nominal ² | <2.5 | <2.5 | <2.5 |
| Flame Spread, Smoke Developed (ASTM E84, UL 723, ULC CAN-S102) | 0/0 | 0/0 | 0/0 |
| Fire Classification | UL certified FM Approvals See page 4 | UL certified FM Approvals See page 4 | UL certified FM Approvals See page 4 |
| Bending Radius | 5 ft. (1524 mm) | 8 ft. (2438 mm) | 12 ft. (3658 mm) |
| Mold Resistance ^{8*} | 10 (highest possible) | 10 (highest possible) | 10 (highest possible) |
| Product Standard Compliance | ASTM C1177 | ASTM C1177 | ASTM C1177 |

*Tested internally.

1 Represents approximate weight for design and shipping purposes. Actual weight may vary based on manufacturing location and other factors.

2 Tested in accordance with ASTM C473, method B.

3 Tested in accordance with ASTM E661.

4 Tested in accordance with ASTM E96 (dry cup method).

5 Tested in accordance with ASTM C518 (heat flow meter) internal evaluation.

6 Specified values per ASTM C1177.

7 Tested in accordance with ASTM C473 internal evaluation.

8 When tested, as manufactured, in accordance with ASTM D3273, DensDeck® Roof Boards have scored a 10, the highest level of performance for mold resistance under the ASTM D3273 test method. The score of 10, in the ASTM D3273 test, indicates no mold growth in a 4-week controlled laboratory test. The mold resistance of any building product when used in actual jobsite conditions may not produce the same results as were achieved in the controlled laboratory setting. No material can be considered mold proof. For additional information, go to buildgpc.com/safetyinfo.

PHYSICAL PROPERTIES

DensDeck® Prime Roof Board

| Properties | 1/4 in. (6.4 mm) | 1/2 in. (12.7 mm) | 5/8 in. (15.9 mm) |
|---|--|--|--|
| Thickness, nominal | 1/4 in. (6.4 mm) ± 1/16 in. (1.6 mm) | 1/2 in. (12.7 mm) ± 1/32 in. (0.8 mm) | 5/8 in. (15.9 mm) ± 1/32 in. (0.8 mm) |
| Width, standard | 4 ft. (1219 mm) ± 1/8 in. (3 mm) | 4 ft. (1219 mm) ± 1/8 in. (3 mm) | 4 ft. (1219 mm) ± 1/8 in. (3 mm) |
| Length, standard | 4 ft. (1219 mm) & 8 ft. (2438 mm) ± 1/4 in. (6.4 mm) | 4 ft. (1219 mm) & 8 ft. (2438 mm) ± 1/4 in. (6.4 mm) | 4 ft. (1219 mm) & 8 ft. (2438 mm) ± 1/4 in. (6.4 mm) |
| Weight, nominal, lbs./sq. ft. (kg/m ²) ¹ | 1.2 (5.9) | 2.0 (9.8) | 2.5 (12.2) |
| Surfacing | Fiberglass mat with non-asphaltic coating | Fiberglass mat with non-asphaltic coating | Fiberglass mat with non-asphaltic coating |
| Flexural Strength ² , parallel, lbf. min. (N) | ≥40 (178) | ≥80 (356) | ≥100 (444) |
| Flute Spanability ³ | 2-5/8 in. (66.7 mm) | 5 in. (127 mm) | 8 in. (203 mm) |
| Permeance ⁴ , perms (ng/Pa•S•m ²) | >30 (>1710) | >23 (>1300) | >17 (>970) |
| R Value ⁵ , ft ² •°F•hr/BTU (m ² •K/W) | .28 | .56 | .67 |
| Linear Variation with Change in Temp., in/in/°F (mm/mm/°C) | 8.5x10 ⁻⁶ (15.3x10 ⁻⁶) | 8.5x10 ⁻⁶ (15.3x10 ⁻⁶) | 8.5x10 ⁻⁶ (15.3x10 ⁻⁶) |
| Linear Variation with Change in Moisture, mm/mm/% RH (in/in/% RH) | 6.25x10 ⁻⁶ | 6.25x10 ⁻⁶ | 6.25x10 ⁻⁶ |
| Water Absorption ⁶ , % max | 5.0 | 5.0 | 5.0 |
| Compressive Strength ⁷ , psi nominal (kPa)* | 900 (6205) | 900 (6205) | 900 (6205) |
| Surface Water Absorption, grams, nominal ² | 1.0 | 1.0 | 1.0 |
| Flame Spread, Smoke Developed (ASTM E84, UL 723, ULC CAN-S102) | 0/0 | 0/0 | 0/0 |
| Fire Classification | UL certified FM Approvals See page 4 | UL certified FM Approvals See page 4 | UL certified |
| Bending Radius | 4 ft. (1219 mm) | 6 ft. (1829 mm) | 8 ft. (2438 mm) |
| Mold Resistance ⁸ | 10 (highest possible) | 10 (highest possible) | 10 (highest possible) |
| Product Standard Compliance | ASTM C1177 | ASTM C1177 | ASTM C1177 |

DensDeck® StormX™ Prime Roof Board

| Properties | 5/8 in. (15.9 mm) |
|---|--|
| Thickness, nominal | 5/8 in. (15.9 mm) ± 1/32 in. (0.8 mm) |
| Width, standard | 4 ft. (1219 mm) ± 1/8 in. (3 mm) |
| Length, standard | 4 ft. (1219 mm) & 8 ft. (2438 mm) ± 1/4 in. (6.4 mm) |
| Weight, nominal, lbs./sq. ft. (kg/m ²) ¹ | 3.0 (14.6) |
| Surfacing | Fiberglass mat with non-asphaltic coating |
| Flexural Strength ² , parallel, lbf. minimum (N) | ≥200 (888) |
| Flute Spanability ³ | 18 in. (457 mm) |
| Permeance ⁴ , perms (ng/Pa•S•m ²) | >17 (>970) |
| R Value ⁵ , ft ² •°F•hr/BTU (m ² •K/W) | .67 |
| Linear Variation with Change in Temp., in/in/°F (mm/mm/°C) | 8.5x10 ⁻⁶ (15.3x10 ⁻⁶) |
| Linear Variation with Change in Moisture, mm/mm/% RH (in/in/% RH) | 11.7x10 ⁻⁶ (459333x10 ⁻⁶) |
| Water Absorption ⁶ , % max | 5.0 |
| Compressive Strength ⁷ , psi nominal (kPa)* | 1800 (12410) |
| Surface Water Absorption, grams, nominal ² | 1.0 |
| Mold Resistance ⁸ | 10 (highest possible) |
| Product Standard Compliance | ASTM C1177 |
| Fire Classification | UL certified FM Approvals. See page 4. |

1 Represents approximate weight for design and shipping purposes. Actual weight may vary based on manufacturing location and other factors.

2 Tested in accordance with ASTM C473, method B.

3 Tested in accordance with ASTM E661.

4 Tested in accordance with ASTM E96 (dry cup method).

5 Tested in accordance with ASTM C518 (heat flow meter) internal evaluation.

6 Specified values per ASTM C1177.

7 Tested in accordance with ASTM C473 internal evaluation.

8 When tested, as manufactured, in accordance with ASTM D3273, DensDeck® Roof Boards have scored a 10, the highest level of performance for mold resistance under the ASTM D3273 test method. The score of 10, in the ASTM D3273 test, indicates no mold growth in a 4-week controlled laboratory test. The mold resistance of any building product when used in actual jobsite conditions may not produce the same results as were achieved in the controlled laboratory setting. No material can be considered mold proof. For additional information, go to buildgp.com/safetyinfo.

RECOMMENDATIONS AND LIMITATIONS FOR USE

The following recommendations and limitations, together with the delivery, storage, handling and other guidelines contained in this guide, are given to help ensure satisfactory performance from DensDeck® Roof Boards. Failure to adhere to such recommendations and limitations may void the limited warranty provided by Georgia-Pacific Building Products for these products.

DensDeck® Prime Roof Board (1/2 in. (12.7 mm) and 5/8 in. (15.9 mm) only) and DensDeck® StormX™ Prime Roof Board (5/8 in.) are backed with a limited warranty for up to 90 days of exposure to normal weather conditions when applied on vertical parapet walls. For additional details and warranty information for DensDeck® Roof Boards, please go to DensDeck.com.

Georgia-Pacific Building Products does not warrant and does not provide specifications or instructions for any specific assembly or system utilizing DensDeck® Roof Boards or any component in such assemblies or systems other than DensDeck® Roof Boards. Any references to assemblies or systems are for illustration or general information only. Consult with the appropriate system manufacturer and/or design authority for system specifications and instructions. In case of conflicting recommendations, system manufacturers and/or design authorities should prevail.

Design

DensDeck® Roof Boards are manufactured to act with a properly designed roof system following good roofing practices. The actual use of DensDeck® Roof Boards as a roofing component in any system or assembly is the responsibility of the roofing system's designing authority. Georgia-Pacific Building Products does not offer roofing system design services and neither warrants, nor is responsible for, any systems or assemblies utilizing DensDeck® Roof Boards or any component in such systems or assemblies other than DensDeck® Roof Boards.

The need for a separator sheet between DensDeck® Roof Boards and the roofing membrane must be determined by the roof membrane manufacturer or roofing system designer.

Confirm any priming requirements of DensDeck® Roof Boards with membrane manufacturer.

The entry of water vapor and its subsequent condensation can be detrimental to a roof's performance, including the performance of DensDeck® Roof Boards. Vapor retarders can be used to control migration of water vapor into the roof system. Determining the need for a vapor retarder, its compatibility with other materials, such as structural concrete decks, and the details of its construction is the responsibility of the designer.

Application

When applying solvent-based adhesives or primers, allow sufficient time for the solvent to flash off to avoid damage to roofing components.

DensDeck® Roof Board and DensDeck® Prime Roof Board should not be subjected to abnormal or excessive loads or foot traffic, such as, but not limited to, use on plaza decks or under steel-wheeled equipment that may fracture or damage the panels. Provide suitable roofing system protection when required.

When Roof Top Paver Pedestal Systems are applied over DensDeck® Roof Boards, the calculated pedestal PSI loads with safety factor shall not exceed the compressive strength of the board.

For hot mopping asphalt or coal tar directly to DensDeck® Prime Roof Board, follow the manufacturer's recommended system application temperature guidelines and good roofing practices.

DensDeck® Prime Roof Board is the preferred substrate for torch application. However, the product must be dry prior to commencing installation of torch application.

- Ensure product is dry. Ensure proper torching technique.
- Limit the heat to the roof board.
- Maintain a majority of the torch flame directly on the roll.
- When torching to DensDeck® Prime Roof Board or DensDeck® StormX™ Prime Roof Board, field priming should not be required.

Installation

Apply only as many DensDeck® Roof Boards as can be covered by a roof membrane system in the same day.

DensDeck® Roof Boards of any thickness do not require gapping. Board edges and ends should be butted tightly together. When installed on a structural metal deck, edge joints should be located on and parallel to top flutes, so that edges are supported.

Independent evaluations have demonstrated that hot mopping to DensDeck® Roof Boards is an acceptable method of bonding membranes. However, the product must be dry prior to commencing installation of hot asphalt application, with free moisture content less than 1% using a moisture meter that has been set to the gypsum scale.

RECOMMENDATIONS AND LIMITATIONS FOR USE

- When using DensDeck® Roof Board or DensDeck® Prime Roof Board, Georgia-Pacific Building Products recommends maximum asphalt application temperatures of 425°F (218°C) to 450°F (232°C). Application temperatures above these recommended temperatures may adversely affect roof system performance. Consult and follow roofing system manufacturer's specifications for full mopping applications and temperature requirements.
- Follow accepted roofing industry guidelines for full mopping applications such as EVT temperature guidelines, brooming and proper application rates of asphalt.

DensDeck® Prime Roof Board and DensDeck® StormX™ Prime Roof Board may be flood mopped to a substrate followed by a flood mopped application of membrane using these guidelines:

- DensDeck® Prime Roof Board and substrate must be dry.
- Asphalt used to install DensDeck® Prime Roof Board should be allowed to cool prior to mopping base sheet to top of boards.
- Allow base ply to cool before mopping additional plies or cap sheet to limit the amount of direct heat that is applied to boards.

Moisture Management

Conditions beyond the control of Georgia-Pacific Building Products, such as weather conditions, dew, leaks, application temperatures and techniques may cause adverse effects with roofing systems. All components used in roofing systems, including DensDeck® Roof Boards, must be protected from exposure to moisture before, during and after installation. Although DensDeck® Roof Boards are engineered with fiberglass facings and high-density gypsum cores, the presence of moisture can have a detrimental effect on the performance of the product and the installation of roofing membranes.

To ensure that the DensDeck® Roof Boards remain dry prior to installation, the materials must be properly handled upon receipt. Remove any plastic packaging from all DensDeck® Roof Boards immediately upon receipt of delivery. Failure to remove plastic packaging may result in entrapment of condensation or moisture, which may cause application problems that are not the responsibility of Georgia-Pacific Building Products.

Any protective, plastic factory packaging that is used to wrap DensDeck® Roof Boards for shipment is intended to provide temporary protection from moisture exposure during transit only and is not intended to provide protection during storage after delivery.

DensDeck® Roof Boards stored outside must be stored level, off the ground and protected by a waterproof covering. Provide means for air circulation around and under stored bundles of DensDeck® Roof Boards. Use adequate supports to keep the bundles flat, level and dry.

Moisture can cause blisters to form during hot mopping or torching to any substrate. Because DensDeck® Roof Boards are relatively dense, any excess moisture will typically vaporize and travel upward into the interface between the membrane and substrate rather than dissipating within the board. In fully adhered single-ply or cold mastic bitumen systems, the evaporation of solvents may be restricted and may cause solvent blisters.

Moisture accumulation may also adversely affect the structural stability or bond of roofing system components, including DensDeck® Roof Boards, and may significantly decrease wind uplift and vertical pull resistance in the system or assembly. DensDeck® Roof Boards exposed to moisture may need to be evaluated for structural stability to assure wind-uplift performance.

Care should also be taken during installation to avoid the accumulation of moisture in the system. DensDeck® Roof Boards must be covered the same day as installed. Avoid application of DensDeck® Roof Boards during rain, heavy fog and any other conditions that may deposit moisture on the surface, and avoid the overuse of non-vented, direct-fired heaters during winter months. When roofing systems are installed on new poured concrete or lightweight concrete decks or when re-roofing over an existing concrete deck, a vapor retarder should be installed above the concrete to limit the migration of water from the concrete into the roof assembly. Always consult the roofing system manufacturer or design authority for specific instructions on applying other products to DensDeck® Roof Boards.

Finally, care must be taken after installation to avoid and properly manage leaks and other water accumulation. Moisture vapor movement by convection must be eliminated, and the flow of water by gravity through imperfections in the roof system must be controlled. After a leak has occurred, no condensation on the upper surface of the system should be tolerated, and the water introduced by the leak must be dissipated to the building interior in a minimum amount of time.

RECOMMENDATIONS AND LIMITATIONS FOR USE

- When using DensDeck® Roof Board or DensDeck® Prime Roof Board, Georgia-Pacific Building Products recommends maximum asphalt application temperatures of 425°F (218°C) to 450°F (232°C). Application temperatures above these recommended temperatures may adversely affect roof system performance. Consult and follow roofing system manufacturer's specifications for full mopping applications and temperature requirements.
- Follow accepted roofing industry guidelines for full mopping applications such as EVT temperature guidelines, brooming and proper application rates of asphalt.

DensDeck® Prime Roof Board and DensDeck® StormX™ Prime Roof Board may be flood mopped to a substrate followed by a flood mopped application of membrane using these guidelines:

- DensDeck® Prime Roof Board or DensDeck® StormX™ Prime Roof Board and substrate must be dry.
- Asphalt used to install DensDeck® Prime Roof Board or DensDeck® StormX™ Prime Roof Board should be allowed to cool prior to mopping base sheet to top of boards.
- Allow base ply to cool before mopping additional plies or cap sheet to limit the amount of direct heat that is applied to boards.



Georgia-Pacific Gypsum

U.S.A. GP Gypsum LLC
Canada Georgia-Pacific Canada LP

SALES INFORMATION AND ORDER PLACEMENT

| | |
|------------------------|------------------------------|
| U.S.A. Northeast: | 1-800-947-4497 |
| Southeast: | 1-800-327-2344 |
| Pacific Southwest: | 1-800-824-7503 |
| Pacific Northwest: | 1-800-444-0092 |
| Midwest: | 1-800-876-4746 |
| Central: | 1-800-231-6060 x 7709 |
| CANADA Eastern Canada: | 1-800-387-6823 |
| Western Canada: | 1-800-558-0092 |
| DENSDECK | 1-855-647-3325 |

TECHNICAL HOTLINE

U.S.A. and Canada: **1-800-225-6119**



TRADEMARKS –

Unless otherwise noted, all trademarks are owned by or licensed to Georgia-Pacific Building Products. MICROSOFT is a registered trademark of Microsoft Corporation. MASTERSPEC is a registered trademark of The American Institute of Architects. REVIT is a registered trademark of Autodesk, Inc. RoofNav is a registered mark of FM Approvals LLC.

WARRANTIES, REMEDIES AND TERMS OF SALE –

For current warranty information, please go to buildgp.com/warranties and select the applicable product. All sales by Georgia-Pacific are subject to our Terms of Sale available at buildgp.com/tc.

UPDATES AND CURRENT INFORMATION –

The information in this document may change without notice. Visit our website at buildgp.com/gypsum for updates and current information.

CAUTION: For product fire, safety and use information, go to buildgp.com/safetyinfo or call 1-800-225-6119.

HANDLING AND USE –

WARNING: Provide appropriate exhaust ventilation at places where dust is formed. Minimize dust generation and accumulation. Do not breathe dust. Do not get this material in contact with eyes. Do not taste or swallow. Avoid prolonged exposure. Observe good industrial hygiene practices. Use only in well-ventilated areas. Wear appropriate NIOSH/MSHA approved dust mask or filtering facepiece if dust is generated. Do not eat or drink while using the product. Wash hands before eating, drinking or smoking.

FIRE SAFETY CAUTION –

Passing a fire test in a controlled laboratory setting and/or certifying or labeling a product as having a one-hour, two-hour or any other fire resistance or protection

rating and, therefore, as acceptable for use in certain fire-rated assemblies/systems, does not mean that either a particular assembly/system incorporating the product, or any given piece of the product itself, will necessarily provide one-hour fire resistance, two-hour fire resistance or any other specified fire resistance or protection in an actual fire. In the event of an actual fire, you should immediately take any and all actions necessary for your safety and the safety of others without regard for any fire rating of any product or assembly/system.

DensDeck.com

©2024 Georgia-Pacific Gypsum. All rights reserved. Unless otherwise noted, all trademarks are owned by or licensed to GP Gypsum LLC. Rev 07/24 Lit#: 622602