

INSTALLATIONSANLEITUNG

DIAL COMBO | EINLASSMONTAGE MIT GRIF | RIEGEL | FALLE | HEBEL | GEKRÖPFTER HEBEL

VERSION 1

DATUM: 101325

PG-D6CL-1X-XX-3-GER



STANDARDGEHÄUSE MIT GRIF

MECHANISCHE RÜCKEINHEITEN



12MM RIEGEL



8MM RIEGEL



12MM FALLE



8MM FALLE



FLACHER HEBEL



GEKRÖPFTER HEBEL

Einlassmontage mit Griff - 8mm Riegel/Falle - 12mm Riegel/Falle

Für Türstärken zwischen [12,5mm - 38mm]

Erforderliche Komponenten und Werkzeug	1
Installation.....	2

Einlassmontage mit Griff - Flacher Hebel

Für Türstärken zwischen [12,5mm - 32mm]

Erforderliche Komponenten und Werkzeug	3
Installation.....	4

Einlassmontage mit Griff - gekröpfter Hebel

Für Türstärken zwischen [12,5mm - 20mm]

Erforderliche Komponenten und Werkzeug	5
Installation.....	6

Einlassmontage mit Griff, Einsteckschablone	7
---	---

Garantie	8
----------------	---

Kontaktinformationen	9
----------------------------	---

Für Türstärken zwischen 12,5mm - 38mm

ERFORDERLICHE KOMPONENTEN

VORDERE EINHEIT

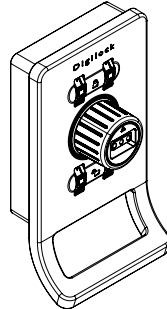

Standardgehäuse mit Griff

HINTERE EINHEIT

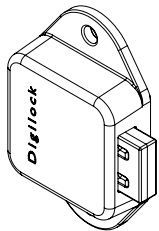

8mm Riegel

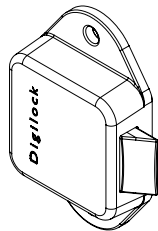

8mm Falle

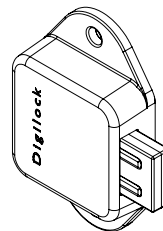

12mm-Riegel

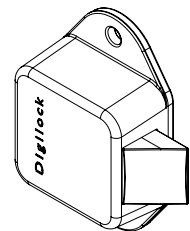

12mm-Falle

HARDWARE

2 - #10-24 Flachkopf-Phillips-Schrauben

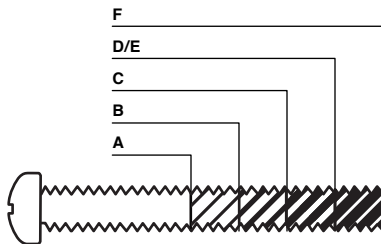

Schraube Größe	Länge	Türstärke	
		Min	Max
A	1/2" [12,70mm]	12,5mm	17,0mm
B	3/4" [19,05mm]	20,5mm	24,0mm
C	7/8" [22,22mm]	23,5mm	27,0mm
D	1 1/8" [28,57mm]	27,0mm	31,5mm
E	1 1/8" [28,57mm] (mit Verlängerungsstück)	31,0mm	33,0mm
F	1 3/8" [34,92mm]	33,0mm	38,0mm

ERFORDERLICHES WERKZEUG

* Nicht inbegriffen

1 - Kreuzschlitzschraubendreher (#2)*

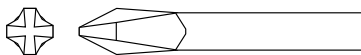

Anmerkung: Es wird empfohlen, nur Drehmoment **5 oder niedriger** bei Verwendung einer Bohrmaschine einzustellen, um ein Überdrehen zu vermeiden.

MONTAGE

Zur Veranschaulichung ist die hintere Einheit mit einem 12mm-Riegel dargestellt.

MONTAGEANSICHTEN

Explosionszeichnung

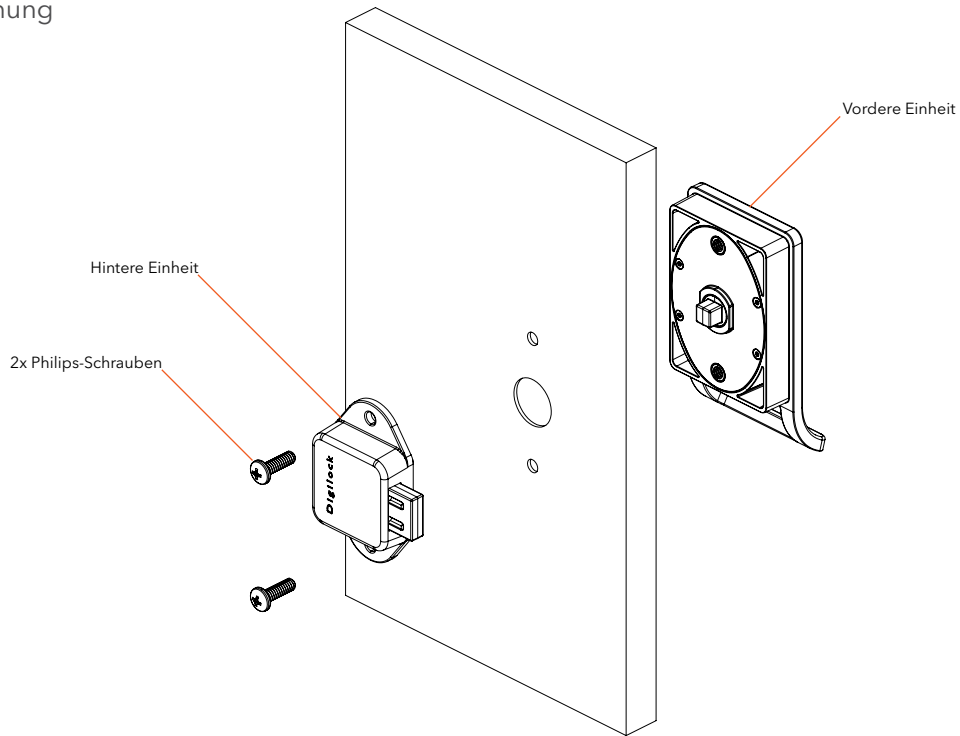

Rückansicht

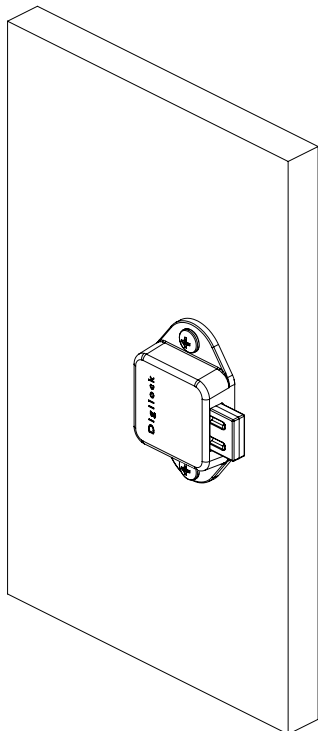

Seitenansicht

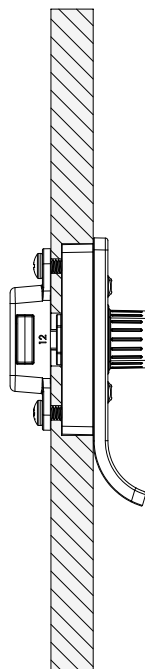

Vordere Ansicht

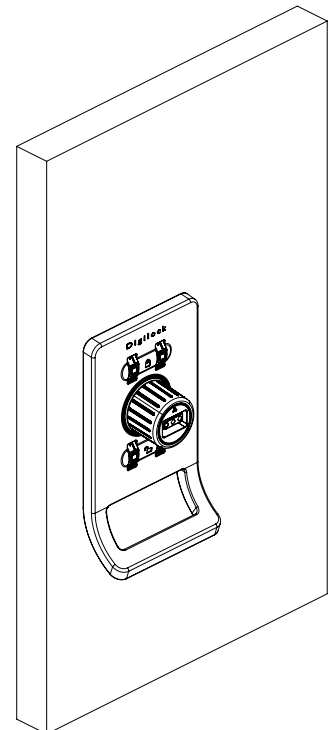

Für Türstärken zwischen [12,5mm - 32mm]

ERFORDERLICHE KOMPONENTEN

VORDERE EINHEIT

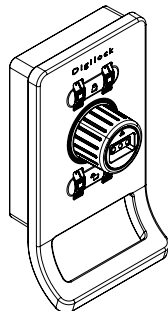

Standardgehäuse mit Griff

HINTERE EINHEIT

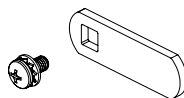

Flacher Hebel

HARDWARE

2 - #10-24 Flachkopf-Phillips-Schrauben

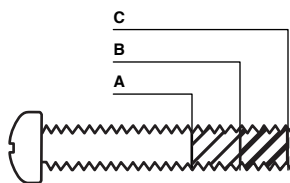

Schraube Größe	Länge	Türstärke	
		Min	Max
A	1/2" [12,70mm]	12,5mm	20,0mm
B	3/4" [19,05mm]	20,0mm	27,0mm
C	1" [25,40mm]	27,0mm	32,0mm

ERFORDERLICHES WERKZEUG

* Nicht inbegriffen

1 - Kreuzschlitzschraubendreher (#2)*

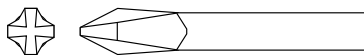

Anmerkung: Es wird empfohlen, nur Drehmoment **5 oder niedriger** bei Verwendung einer Bohrmaschine einzustellen, um ein Überdrehen zu vermeiden.

MONTAGE

MONTAGEANSICHTEN

Explosionszeichnung

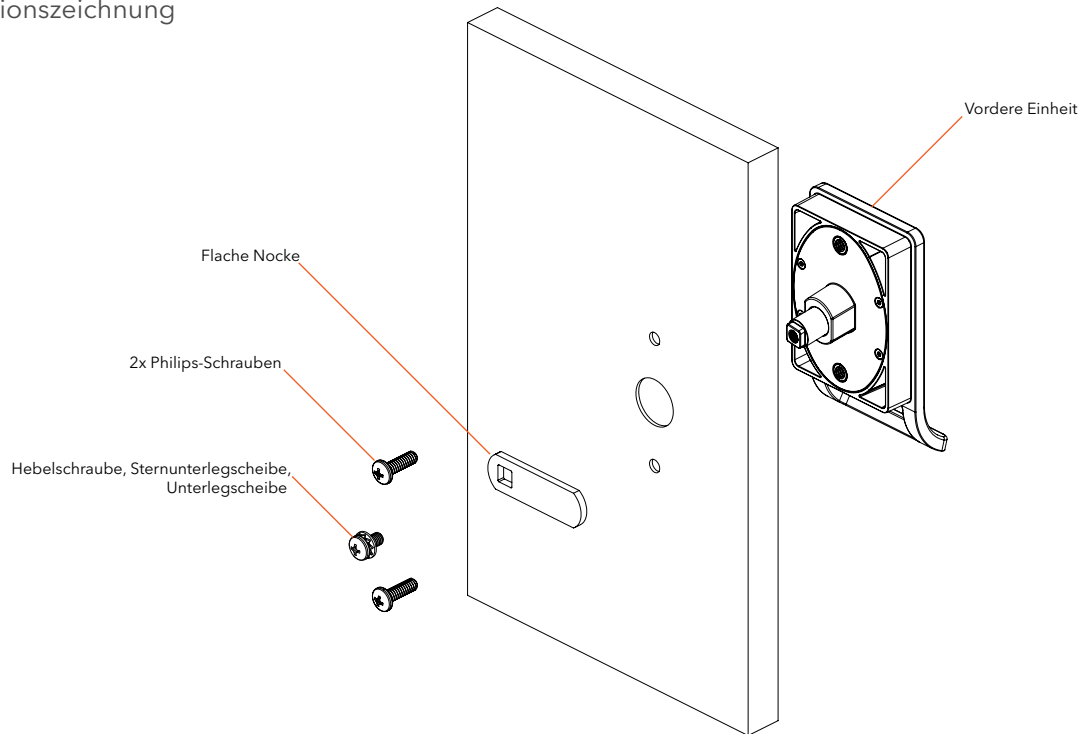

Rückansicht

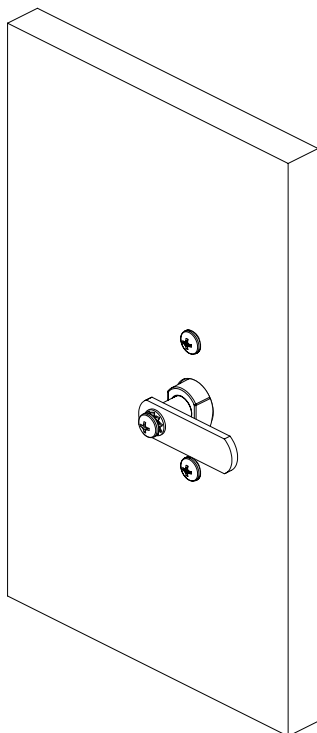

Seitenansicht

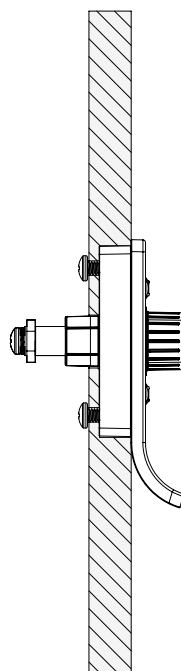

Vordere Ansicht

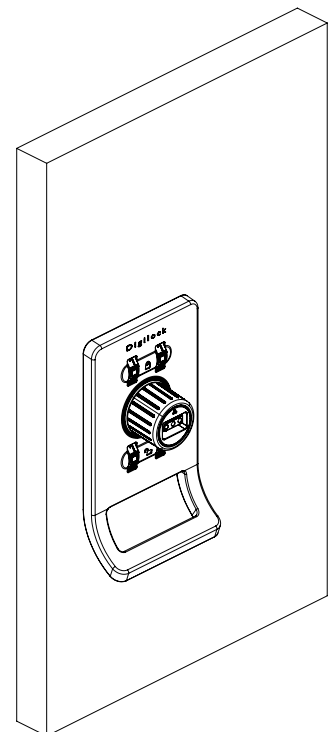

Für Türstärken zwischen [12,5mm - 20mm]

ERFORDERLICHE KOMPONENTEN

VORDERE EINHEIT

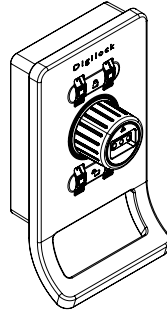

Standardgehäuse mit Griff

HINTERE EINHEIT

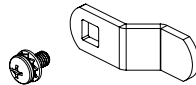

Gekröpfter Hebel

HARDWARE

2 - #10-24 Flachkopf-Phillips-Schrauben

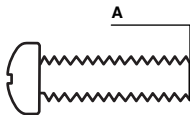

Schraube Größe	Länge	Türstärke	
		Min	Max
A	1/2" [12,70mm]	12,5mm	20,0mm

ERFORDERLICHES WERKZEUG

* Nicht inbegriffen

1 - Kreuzschlitzschraubendreher (#2)*

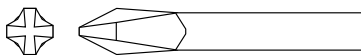

Anmerkung: Es wird empfohlen, nur Drehmoment **5 oder niedriger** bei Verwendung einer Bohrmaschine einzustellen, um ein Überdrehen zu vermeiden.

MONTAGE

MONTAGEANSICHTEN

Explosionszeichnung

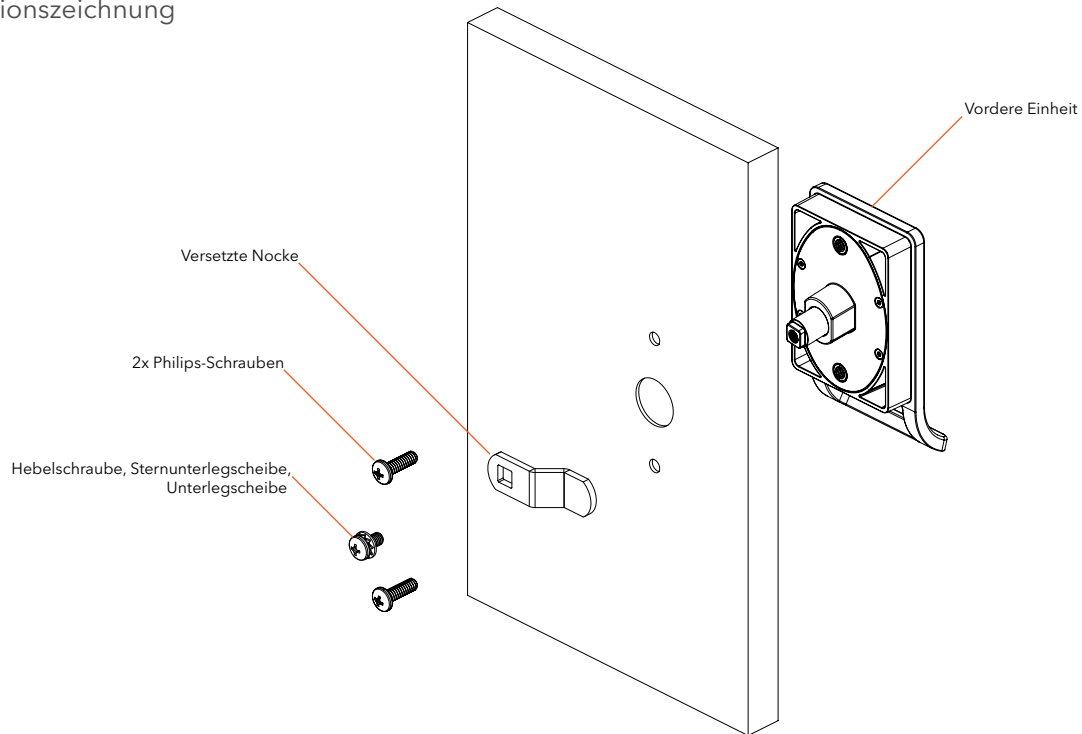

Rückansicht

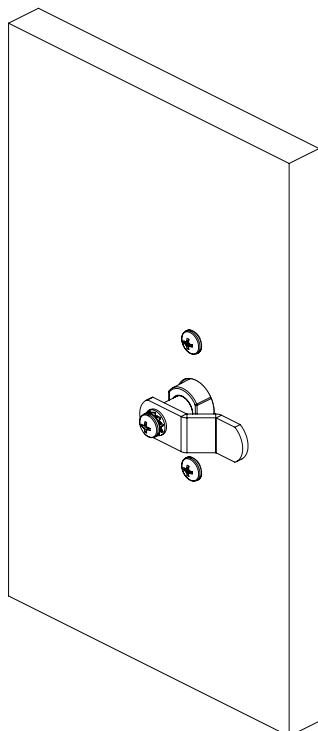

Seitenansicht

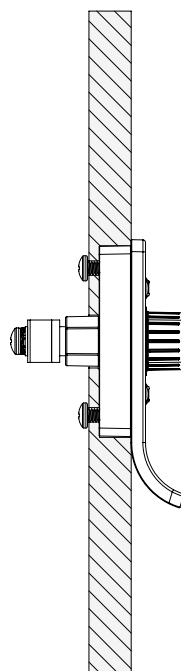

Vordere Ansicht

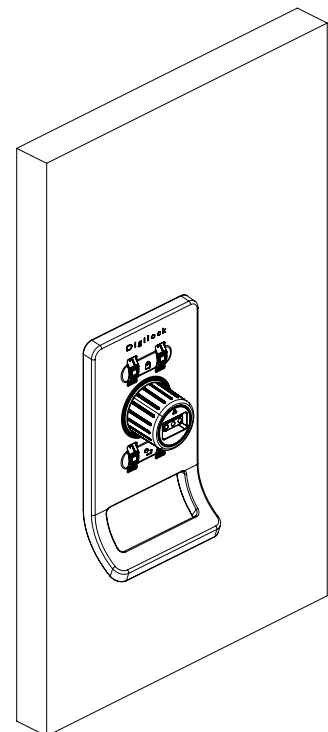

HINWEIS: SCHABLONE BEI 100% DRUCKEN

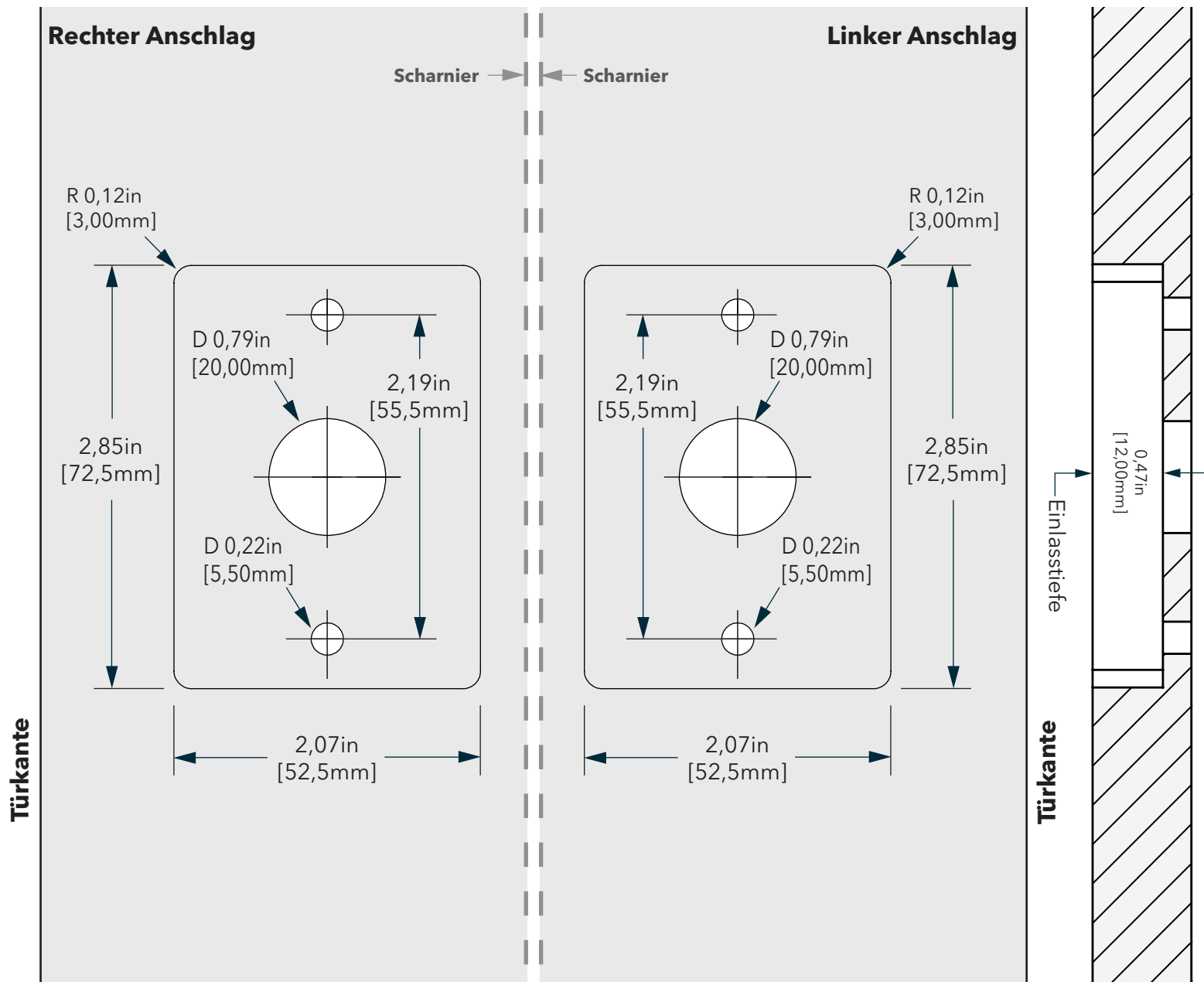

LIMITED WARRANTY. Company warrants to the original purchaser of Product manufactured by Company to be free of defects in material and workmanship, provided: (1) Company has been notified of such defects within two years of purchase date and been given the opportunity of inspection by return of any alleged defective Product to Company, or its authorized distributor, free and clear of liens, encumbrances, transportation prepaid, accompanied by the statement of defects and proof of purchase; and (2) Product has not been subject to modification, abuse, misuse, mishandling, misapplication, neglect (including but not limited to improper maintenance), accident, improper installation, alteration and/or modification (including but not limited to use of unauthorized parts or attachments), disassembly, or adjustment or repair performed by anyone other than an authorized service personnel during such period; and (3) such defect has not been caused by corrosion or ordinary wear and tear. This warranty does not cover batteries, normal wear and tear of parts and/or damage resulting from any of the following: negligent use or misuse of product, use of improper voltage or current, and/or use contrary to operating instructions. The exclusive remedy shall not be deemed to have failed of its essential purpose so long as Company is willing and able to repair or replace non-conforming Product in the prescribed manner.

Unless the product is listed as IP55 rated or otherwise expressed by Company on the sales order acknowledgment, Product is not designed or intended for exterior use or where exposed to moisture. Any use where Product is exposed to moisture is not covered by any warranties and voids any warranties and any resulting damage caused by direct exterior exposure or moisture is at the Buyer's own risk.

The liability of Company for any breach of the foregoing warranty shall not extend to dismantling, installing or reinstalling, but shall be limited to repairing or replacing said items, as Company's option, within a reasonable time after receipt of written notice from Buyer, within the period of time stipulated herein, of any such non-conforming Product, provided that (i) such notice is given immediately upon the detection of such non-conformance and (ii) such notice is received within the time period stipulated herein. BUYER AND COMPANY EXPRESSLY AGREE THAT THE BUYER'S SOLE AND EXCLUSIVE REMEDY AGAINST COMPANY SHALL BE FOR THE REPAIR OR REPLACEMENT (AT COMPANY'S OPTION) OF NON-CONFORMING PRODUCT AS PROVIDED HEREIN.

COMPANY SPECIFICALLY DISCLAIMS ANY OTHER WARRANTIES, EXPRESS, IMPLIED, OR STATUTORY, INCLUDING WITHOUT LIMITATION THE IMPLIED WARRANTY OF FITNESS FOR A PARTICULAR PURPOSE AND THE IMPLIED WARRANTY OF MERCHANTABILITY, AND COMPANY ALSO SPECIFICALLY DISCLAIMS ANY LIABILITY FOR CONSEQUENTIAL OR INCIDENTAL DAMAGES. IN NO EVENT SHALL COMPANY BE LIABLE FOR INCIDENTAL OR CONSEQUENTIAL DAMAGES ARISING OUT OF OR IN CONNECTION WITH THIS AGREEMENT (INCLUDING BUT NOT LIMITED TO BREACH OF ANY OBLIGATION IMPOSED ON COMPANY HEREUNDER OR IN CONNECTION HERewith) OR THE USE, STORAGE, DISPOSAL OR HANDLING OF PRODUCT. Consequential damages for purposes hereof shall include, without limitation, loss of use, income or profit, shutdown, slowdown or stoppage of any production line or facility, or losses sustained as the result of injury (including death) to any person, or loss of or damage to property (including without limitation property handled or processed by the use of Product). Buyer shall indemnify Company against all liability, cost or expense which may be sustained by Company on account of any such loss, damage or injury.

Company will not evaluate warranted Product without Buyer obtaining a Return Merchandise Authorization (RMA) number from Company. Such returns must be prominently marked with the RMA number and shipped prepaid.

Company makes no other warranty, and the warranty is limited to the duration of the expressed warranty period as set forth above

NOTE: Should Product be considered a consumer product as may be covered by the Magnusson Moss Federal Warranty Act, please be advised that: (1) some states do not allow limitations on incidental consequential damages or how long an implied warranty lasts so that the above limitations may not fully apply; (2) this warranty gives specific legal rights, and a buyer may also have other rights which may vary from state to state.

LIMITATION OF LIABILITY. Company's maximum liability for any damages resulting from or caused by Product, whether in contract, tort, or otherwise, is limited to the purchase price of Product. In no event shall Company be liable for any consequential damages of any nature arising from the sale or use of Product, whether in contract, tort or otherwise, by either use or purchase of Product, the user or purchaser agrees to this limit on Company's liability. Company is not responsible for any modification, addition or alteration to Product by others.

Company reserves the right to make changes in designs and specifications or to make additions or improvements on its products without notice and without incurring any obligation to incorporate them on products previously manufactured.

Digilock®

KONTAKTINFORMATIONEN

DIGILOCK AMERIKA

Vertrieb

E-Mail: sales@digilock.com

Telefon: +1 800 989 0201

Support

E-Mail: support@digilock.com

Kostenlose Rufnummer: +1 866 712 7071

DIGILOCK EUROPA BV

Vertrieb

E-Mail: sales@digilock.eu

Telefon: +31 20 303 3060

Support

E-Mail: support@digilock.eu

Kostenlose Rufnummer: +1 866 696 0979

DIGILOCK ASIEN

Vertrieb

E-Mail: sales@digilock.asia

Telefon: +852 2776 0800

Support

E-Mail: support@digilock.asia

Kostenlose Rufnummer: +1 866 699 9180