

CS-1X8HDSP4KEXT

**18Gbps HDMI™
1×8 Splitter over 60m CAT**

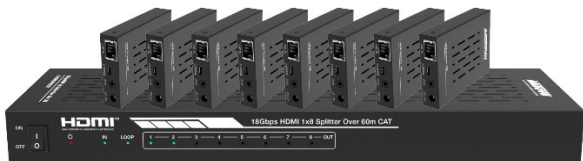

User Manual

VER 1.2

Thank you for purchasing this product

For optimum performance and safety, please read these instructions carefully before connecting, operating or adjusting this product. Please keep this manual for future reference.

Surge protection device recommended

This product contains sensitive electrical components that may be damaged by electrical spikes, surges, electric shock, lightning strikes, etc. Use of surge protection systems is highly recommended in order to protect and extend the life of your equipment.

Table of Contents

| | |
|---|----|
| 1. Introduction. | 1 |
| 2. Features. | 1 |
| 3. Package Contents. | 1 |
| 4. Specifications. | 2 |
| 5. Operation Controls and Functions. | 3 |
| 5.1 Transmitter. | 3 |
| 5.2 CAT Receiver. | 5 |
| 5.3 IR Pin Definition. | 6 |
| 6. EDID Mode. | 7 |
| 7. ASCII Commands. | 8 |
| 8. Application Example. | 11 |

1. Introduction

The 18Gbps HDMI 1x8 Splitter can distribute 1 HDMI source signal to any 8 display devices. Support video resolution up to 4K2K@50/60Hz 4:4:4. It is designed with 1 HDMI loop output and 8 CAT outputs. It can extend the signal transmission distance up to 35 meters at the resolution of 4K2K@60Hz, or 50 meters at 4K2K@30Hz, or 60 meters at 1080P@60Hz via a single CAT6/6a/7 cable. The product supports one-way IR control signal pass-through, audio extract function and advanced EDID management.

2. Features

- ☆ HDMI 2.0, HDCP 2.2 / 1.x and DVI 1.0 compliant
- ☆ Supports 18Gbps video bandwidth
- ☆ Supports video resolution up to 4K2K@50/60Hz 4:4:4
- ☆ Supports 3D, HDR, HDR10+, HLG and Dolby vision
- ☆ Supports up to 7.1CH HD audio pass-through
- ☆ Supports digital and analog audio de-embedded output
- ☆ Extend the signal transmission distance up to 35 meters at the resolution of 4K2K@60Hz, 50 meters at 4K2K@30Hz, 60 meters at 1080P@60Hz via a single CAT6/6a/7 cable
- ☆ Support 1 HDMI input, 1 HDMI loop output and 8 CAT outputs.
- ☆ Support one-way IR control signal pass-through
- ☆ Advanced EDID management
- ☆ Support one-way POC function (only from transmitter to receiver)
- ☆ Compact design for easy and flexible installation

3. Package Contents

- ① 1× 18Gbps 1×8 HDMI Splitter over 60m CAT
- ② 8× CAT Receiver
- ③ 1× IR Blaster Cable (1.5 meters)
- ④ 8× 20K~60KHz IR Receiver Cable (1.5 meters)
- ⑤ 1× 12V/2.5A DC Locking Power Adapter
- ⑥ 1× User Manual

4. Specifications

| Technical | |
|-----------------------|---|
| HDMI Compliance | HDMI 2.0 |
| HDCP Compliance | HDCP 2.2/1.x |
| Video Bandwidth | 594MHz/18Gbps |
| Video Resolution | Up to 4k2k@50/60Hz 4:4:4 |
| Color Depth | 8-bit, 10-bit, 12-bit(1080p@60Hz) 8-bit (4K2K@60Hz YUV4:4:4) 8-bit, 10-bit, 12-bit(4K2K@60Hz YCbCr 4:2:2/4:2:0) |
| Color Space | RGB, YCbCr 4:4:4 / 4:2:2. YUV 4:2:0 |
| HDR | Support HDR10, HDR10+, HLG, Dolby vision |
| HDMI Audio Formats | LPCM, Dolby Digital/Plus/EX, Dolby True HD, DTS, DTS-EX, DTS-96/24, DTS High Res, DTS-HD Master Audio, DSD |
| Coaxial Audio Formats | LPCM2.0, LPCM5.1, Dolby Digital2/5.1CH |
| Analog Audio Formats | PCM 2.0 |
| ESD Protection | Human body model—±8kV (Air-gap discharge) & ±4kV (Contact discharge) |
| Connection | |
| Input | 1×HDMI Type A (19-pin female) |
| Output | 1×HDMI Type A (19-pin female) 8x CAT OUT [RJ45, 8-pin female] 1x Coaxial Audio OUT [RCA] 1x L/R Audio OUT [3.5mm Stereo Mini-jack] |
| Control | 1×SERVICE (Micro USB, Update port) 1x EDID DIAL switch [5-pin] 1x IR OUT [3.5mm Stereo Mini-jack] |

| Mechanical | |
|-----------------------|--|
| Housing | Metal Enclosure |
| Silkscreen Color | Black |
| Dimensions | Transmitter: 300mm (W) × 100mm (D) × 28mm (H) Receiver: 88mm (W) × 61mm (D) × 18mm (H) |
| Weight | Transmitter: 823g Receiver:155g |
| Power Supply | Input: AC100 - 240V 50/60Hz, Output: DC 12V/2.5A (US/EU standards, CE/FCC/UL certified) |
| Power Consumption | 25.44W |
| Operation Temperature | 0°C ~ 40°C / 32°F ~ 104°F |
| Storage Temperature | -20°C ~ 60°C / -4°F ~ 140°F |
| Relative Humidity | 20~90% RH (non-condensing) |

5. Operation Controls and Functions

5.1 Transmitter Panel

Front Panel

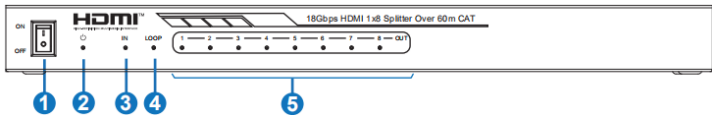

| No. | Name | Function Description |
|-----|---------------|--|
| 1 | POWER switch | Press this switch to power on/off the device. |
| 2 | POWER LED | When the device is powered on, the red power LED will be on. |
| 3 | IN LED | When the HDMI IN port connects an active source device, the green LED will be on. |
| 4 | LOOP LED | When the HDMI LOOP OUT port connects an active display device, the green LED will be on. |
| 5 | OUT LED (1~8) | When the CAT OUTPUT port connects the CAT IN port of CAT receiver, the corresponding green OUT LED will be on. |

Rear Panel

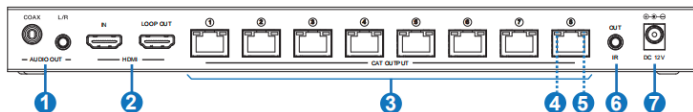

| No. | Name | Function Description |
|-----|-------------------------------------|--|
| 1 | AUDIO OUT (COAX, L/R) | Coaxial/analog audio output port, connect to amplifier or speaker. |
| 2 | HDMI port | IN: HDMI input port, connect to HDMI source device such as DVD or set-top box with an HDMI cable. LOOP OUT: HDMI loop output port, connect to the HDMI display device such as TV or Monitor with an HDMI cable. |
| 3 | CAT OUTPUT port (1~8) | Connect to the CAT IN port of the CAT receiver with a CAT cable. |
| 4 | Link Signal Indicator lamp (Green) | <ul style="list-style-type: none"> ▪ Illuminate: Transmitter and receiver are connected. ▪ Dark: Transmitter and receiver are not connected. |
| 5 | Data Signal Indicator lamp (Orange) | <ul style="list-style-type: none"> ▪ Illuminating: HDMI signal with HDCP. ▪ Flashing: HDMI signal without HDCP. ▪ Dark: No HDMI signal. |
| 6 | IR OUT | Connect the IR Blaster cable to transmit IR signal from the CAT receiver. |
| 7 | DC 12V | Plug the DC 12V power supply into the unit and connect the adaptor to an AC outlet. (Note: The transmitter can power the receiver via a CAT cable.) |

Side Panel

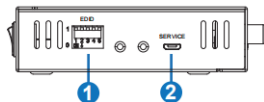

| No. | Name | Function Description |
|-----|------------------|--|
| 1 | EDID DIAL switch | Used to set EDID mode. Please refer to Section "6. EDID Mode" for details. |
| 2 | SERVICE port | Used for firmware update or serial port command control. |

5.2 CAT Receiver

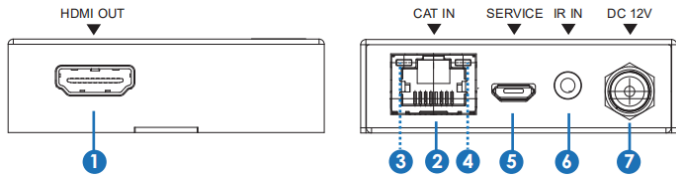

| No. | Name | Function Description |
|-----|-------------------------------------|---|
| 1 | HDMI OUT | HDMI output port, connect to HDMI display device such as TV or Projector with an HDMI cable. |
| 2 | CAT IN | Connect to the CAT OUTPUT port on the transmitter with a CAT cable. |
| 3 | Power Indicator Lamp (Green) | When the receiver is powered on, the power indicator lamp will be on. |
| 4 | Data signal Indicator Lamp (Orange) | <ul style="list-style-type: none"> ▪ Illuminating: HDMI signal with HDCP. ▪ Flashing: HDMI signal without HDCP. ▪ Dark: No HDMI signal. |
| 5 | SERVICE port | Used for firmware update. |
| 6 | IR IN | Connect to the IR Receiver cable. The IR signal will send to the IR OUT port of the transmitter. |
| 7 | DC 12V | Plug DC 12V/1A power supply into the unit and connect the adapter to an AC outlet. (Note: The CAT receiver also can be powered by the transmitter via a CAT cable.) |

5.3 IR Pin Definition



IR RECEIVER



IR BLASTER

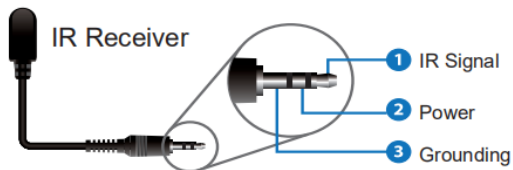
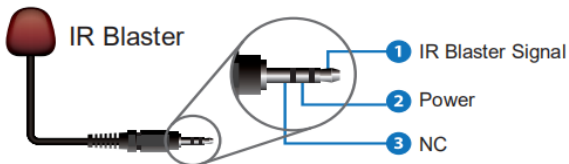

Note: When the angle between the IR receiver and the remote control is $\pm 45^\circ$, the transmission distance is 0-5 meters; when the angle between the IR receiver and the remote control is $\pm 90^\circ$, the transmission distance is 0-8 meters.

6. EDID Mode

The defined EDID setting list of the product is shown as below:

| EDID Mode | EDID Description |
|-----------|------------------------------------|
| 11111 | 1080P, Stereo Audio 2.0 |
| 11110 | 1080P, Dolby/DTS 5.1 |
| 11101 | 1080P, HD Audio 7.1 |
| 11100 | 1080I, Stereo Audio 2.0 |
| 11011 | 1080I, Dolby/DTS 5.1 |
| 11010 | 1080I, HD Audio 7.1 |
| 11001 | 1080P 3D, Stereo Audio 2.0 |
| 11000 | 1080P 3D, Dolby/DTS 5.1 |
| 10111 | 1080P 3D, HD Audio 7.1 |
| 10110 | 4K2K30Hz_444, Stereo Audio 2.0 |
| 10101 | 4K2K30Hz_444, Dolby/DTS 5.1 |
| 10100 | 4K2K30Hz_444, HD Audio 7.1 |
| 10011 | 4K2K60Hz_420, Stereo Audio 2.0 |
| 10010 | 4K2K60Hz_420, Dolby/DTS 5.1 |
| 10001 | 4K2K60Hz_420, HD Audio 7.1 |
| 10000 | 4K2K60Hz_444, Stereo Audio 2.0 |
| 01111 | 4K2K60Hz_444, Dolby/DTS 5.1 |
| 01110 | 4K2K60Hz_444, HD Audio 7.1 |
| 01101 | 4K2K60Hz_444, Stereo Audio 2.0 HDR |
| 01100 | 4K2K60Hz_444, Dolby/DTS 5.1 HDR |
| 01011 | 4K2K60Hz_444, HD Audio 7.1HDR |
| 01010 | COPY_FROM_LOOP OUT |
| 01001 | COPY_FROM_CAT OUT1 |
| 01000 | COPY_FROM_CAT OUT2 |
| 00111 | COPY_FROM_CAT OUT3 |
| 00110 | COPY_FROM_CAT OUT4 |
| 00101 | COPY_FROM_CAT OUT5 |
| 00100 | COPY_FROM_CAT OUT6 |
| 00011 | COPY_FROM_CAT OUT7 |
| 00010 | COPY_FROM_CAT OUT8 |
| 00001 | 1080P, Stereo Audio 2.0 |
| 00000 | PC control mode |

7. ASCII Commands

The product also supports ASCII command control. Connect the SERVICE port of the product to a PC with an USB cable. Then, open a Serial Command tool on PC to send ASCII commands to control the product.

The ASCII command list about the product is shown as below.

| ASCII Commands | | | | |
|---|---|--------------------|--|-----------------|
| Serial port protocol. Baud rate: 115200, Data bits: 8bit, Stop bits:1, Check bit: 0 | | | | |
| x - Parameter 1 y - Parameter 2 ! - Delimiter | | | | |
| Command Code | Function Description | Example | Feedback | Default Setting |
| Power | | | | |
| s power z! | Power on/off the device,z=0~1 (z=0 power off, z=1 power on) | s power 1! | Power on System Initializing... Initialization Finished! FW version x.xx.xx | power on |
| r power! | Get current power state | r power! | power on/power off | |
| s reboot! | Reboot the device | s reboot! | reboot | |
| System Setup | | | | |
| help! | List all commands | help! | | |
| r type! | Get device model | r type! | HDC-SPB18D60 | |
| r status! | Get device current status | r status! | Get the unit all status power, in/out connection, edid mode | |
| r fw version! | Get Firmware version | r fw version! | MCU BOOT: Vx.xx.xx MCU APP: Vx.xx.xx | |
| r link in! | Get the connection status of the input port | r link in! | HDMI IN: connect | |
| r link out y! | Get the connection status of the y output port, y=0~8(0=all, 1~8=CAT 1~8) | r link out 1! | CAT OUT1: connect | |
| r link loop out y! | Get the connection status of the y loop output port, y=1 | r link loop out 1! | HDMI LOOP OUT: connect | |
| s reset! | Reset to factory defaults | s reset! | Reset to factory defaults System Initializing... Initialization Finished! FW version x.xx.xx | |

| Command Code | Function Description | Example | Feedback | Default Setting |
|-----------------------|---|--|--|----------------------------------|
| Output Setting | | | | |
| s hdmi stream z! | Set hdmi loop output stream on/off z=0~1(0:disable,1:enable) | s hdmi stream 1! | Enable hdmi loop out stream Disable hdmi loop out stream | enable |
| s cat y stream z! | Set cat output y stream on/off, y=0~8(0=all) z=0~1 (0:disable,1:enable) | s cat 1 stream 1! s cat 0 stream 1! | Enable cat output 1 stream Disable cat output 1 stream Enable cat all outputs stream Disable cat all outputs stream | enable |
| r hdmi stream! | Get hdmi loop out stream status | r hdmi stream! | Enable hdmi loop output stream | |
| r cat y stream! | Get cat output y stream status, y=0~8(all) | r cat 1 stream! | Enable cat output 1 stream | |
| s hdmi hdcp z! | set hdmi loop output port hdcp status | s hdmi hdcp 1! | hdmi loop out hdcp on | all hdmi out hdcp active |
| r hdmi hdcp! | Get HDCP status of loop out | r hdmi hdcp! | hdmi loop out hdcp on | |
| s cat y hdcp z! | set cat output y port hdcp status y=0~2(0=all) z=0~1 (1=on,0=off) | s cat 1 hdcp 1! | cat out 1 hdcp on | all cat out hdcp active |
| r cat y hdcp! | Get HDCP status of cat out y, y=0~2(0=all) | r cat 1 hdcp! | cat out 1 hdcp on | |
| s cat y dsc mode z! | set cat output y port dsc mode status y=0~8(0=all) z=1~3 (1=Cat cable distance normal Mode, 2= Cat cable distance 35M Mode,3= Cat cable distance 70M Mode) | s cat 1 dsc mode 2! | cat out 1 dsc mode 2 | Cat cable distance 35M Mode(35M) |
| r cat y dsc mode! | Get dsc mode of cat out y, y=0~8(0=all) | r cat 1 dsc mode! | cat out 1 dsc mode 2 | |
| s audio mute 1! | set audio output port mute status (1-mute, 0-umute) | s audio mute 1! | s audio mute 1 | s audio unmute (0) |
| r audio mute! | Get audio output mute status | r audio mute! | audio mute 1 | |

| Command Code | Function Description | Example | Feedback | Default Setting |
|---------------------|---|-------------------|---|------------------------|
| EDID Setting | | | | |
| s edid in from z! | Set input EDID from default EDID z, z=1~30 1. 1080p,Stereo Audio 2.0 2. 1080p,Dolby/DTS 5.1 3. 1080p,HD Audio 7.1 4. 1080i,Stereo Audio 2.0 5. 1080i,Dolby/DTS 5.1 6. 1080i,HD Audio 7.1 7. 3D,Stereo Audio 2.0 8. 3D,Dolby/DTS 5.1 9. 3D,HD Audio 7.1 10. 4K2K30_444, Stereo Audio 2.0 11. 4K2K30_444, Dolby/DTS 5.1 12. 4K2K30_444,HD Audio 7.1 13. 4K2K60_420, Stereo Audio 2.0 14. 4K2K60_420, Dolby/DTS 5.1 15. 4K2K60_420,HD Audio 7.1 16. 4K2K60_444, Stereo Audio 2.0 17. 4K2K60_444, Dolby/DTS 5.1 18. 4K2K60_444,HD Audio 7.1 19. 4K2K60_444, Stereo Audio 2.0 HDR 20. 4K2K60_444, Dolby/DTS 5.1 HDR 21. 4K2K60_444, HD Audio 7.1 HDR 22. copy from hdmi loop out 23. copy from cat output 1 24. copy from cat output 2 25. copy from cat output 3 26. copy from cat output 4 27. copy from cat output 5 28. copy from cat output 6 29. copy from cat output 7 30. copy from cat output 8 | s edid in from 1! | input EDID:1080p, Stereo Audio 2.0 Please toggle EDID dip switch to 00000! | 1080p,Stereo Audio 2.0 |
| r edid in! | Get EDID status of the input | r edid in! | input EDID: 4K2K60_444,Stereo Audio 2.0 | |
| r edid in data! | Get the EDID data of the hdmi input | r edid in data! | EDID data : 00 FF FF FF FF FF FF 00 | |

7. Application Example

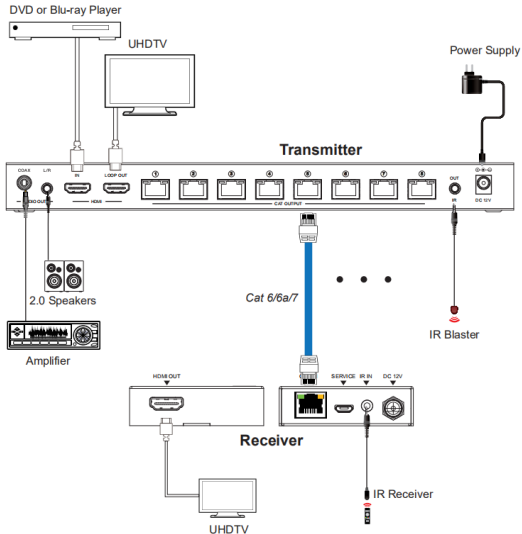

HDMI™
HIGH DEFINITION MULTIMEDIA INTERFACE

The terms HDMI and HDMI High-Definition Multimedia interface, and the HDMI Logo are trademarks or registered trademarks of HDMI Licensing LLC in the United States and other countries.

MetraAV™
THE INTEGRATOR'S CHOICE

©2022 Metra AV

460 Walker Street, Holly Hill, FL 32117-2699

Specifications are subject to change without notice.

All trademarks are the property of their respective owners.

386-255-0234