

INFRARED REPEATER KIT



CELEBRATING
75
YEARS
OF INNOVATION

INFRARED REPEATER SYSTEM

CS-IRKIT1US

User Manual



460 Walker Street
Holly Hill, FL 32117-2699
htsupport@etherealpro.com
www.EtherealPro.com
386.255.0234 | 386.257.1186

 **Tech Support**
386.492.8584

Safety Warnings

1. To prevent short circuits, this product should only be used inside and only in dry spaces. Do not expose the components to rain or moisture. Do not use the product close to a bath, swimming pool etc.
2. Do not expose the components of your systems to extremely high temperatures or bright light sources.
3. In case of improper usage or if you have altered and repaired the product yourself, all guarantees expire.
4. We do not accept responsibility in the case of improper usage of this product. We do not accept claims of responsibility for damage caused by improper usage of this product.
5. Do not open the product: the device may contain live parts. The product should only be repaired or serviced by Metra Home Theater Group.
6. Only connect the adapter to power after checking whether the voltage is the same as the values on the identification tags. Never connect an adapter when it is damaged. In that case, contact your supplier.
7. This product is not a toy. Keep out of reach of children.

Introduction

Thanks for buying our CS-IRKIT1US. With it you can extend the IR (infrared) signals of a remote control. This IR Repeater system makes it possible to control multiple devices while these are in a closed cupboard or in a remote location out of sight.

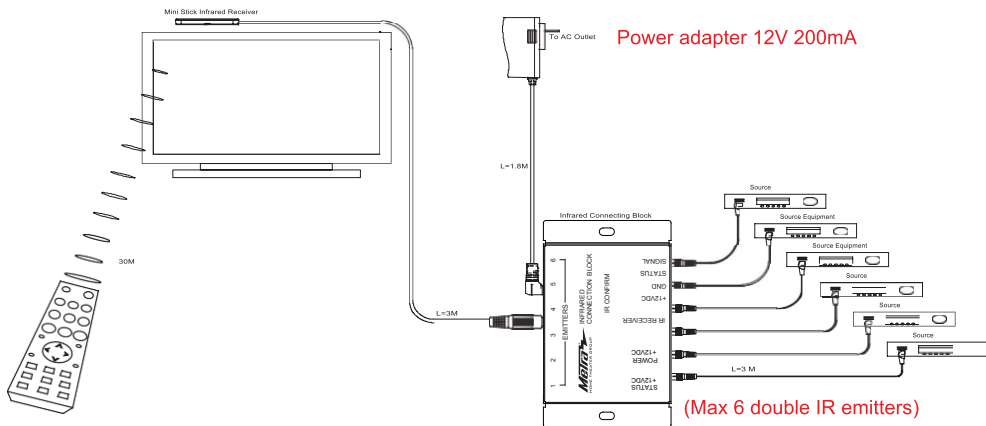

1. Package Contents

IR Connecting Block x 1

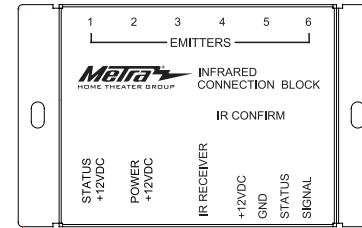

IR Receiver x

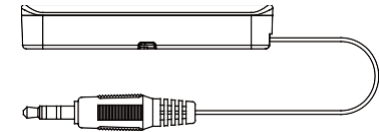

Single IR Emitter x 4

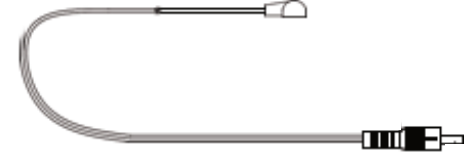

12V Power Supply x 1

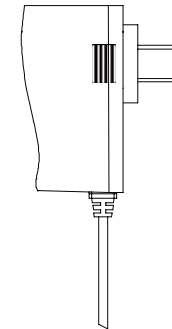

User Manual x 1

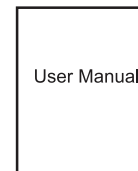

2. Installation

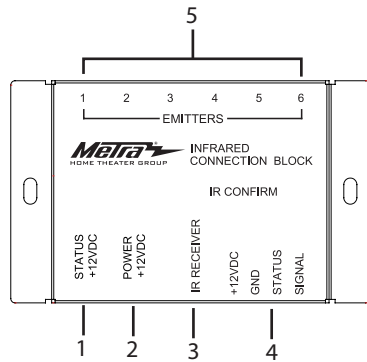

- | | |
|--|---|
| <p>1. STATUS</p> <p>2. POWER</p> <p>3. Receiver</p> <p>4. Terminal block</p> <p>5. EMITTER 1 to 6</p> <p>6. IR confirmation LED</p> <p>7. Mounting holes</p> | <p>Connection for a STATUS power adapter.</p> <p>Connection for the Power Adapter</p> <p>Connection for IR receiver</p> <p>Connection for extra IR receivers</p> <p>Connection for Max of 6 Dual IR emitters</p> <p>Displays when an IR signal is present</p> <p>For mounting the IR connecting block</p> |
|--|---|

◆ Dual Band Mini Stick Infrared Receiver

Wire connections

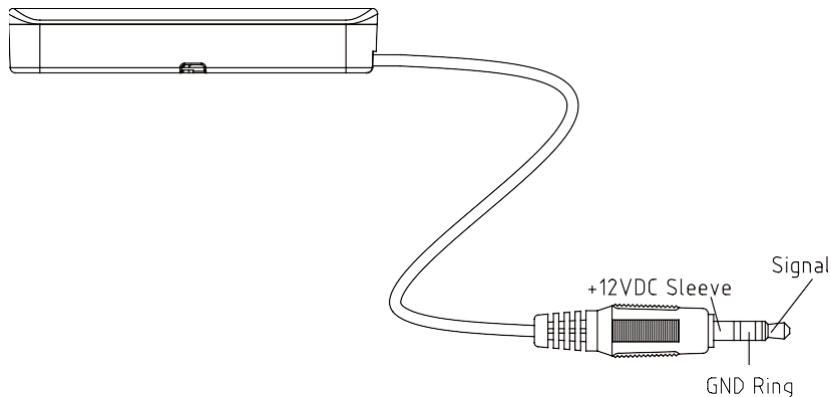

◆ Single IR Emitter

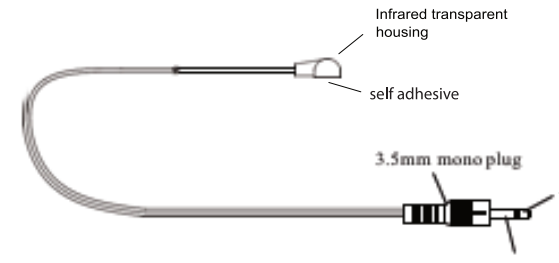

1. Install the IR connecting block at an accessible location behind or next to your AV equipment and near a 110V plug. Take into account of the IR emitter cable's length and make sure that the connections are kept accessible.
 2. Plug the required IR emitter cables into the IR connecting block. A self-adhesive foil is supplied with the IR emitter cables. With that you can fasten the IR emitter to the IR window of your AV equipment.
- Note:** Test the position and working of the IR emitter before fixing them permanently to the IR window of your AV equipment.
3. Now connect the IR receiver cable to the IR connecting block.
 4. If you want to connect more IR receivers to the IR connecting block, you need to connect the terminated IR receiver cable (without 3.5mm stereo plug, not supplied) to the terminal block INPUT, there are some different connection ways, will be described separately below.
 5. Place the supplied IR receiver cable in such a way that it is visible for your infrared remote control. Experiment for the correct place before you fix the IR receiver cable definitively by using the supplied self-adhesive strip.
- Note:** The adhesive strip can cause discoloration on certain surfaces or leave glue remnants when removed.
6. Connect the power adapter to the "POWER" connection of the IR connecting block and plug the adapter to a wall plug. Check if the "POWER" LED is on after plugging

3. Different Connections

There are several different connection methods for this IR repeater system.

Connection 1

Power adapter 12V 200mA

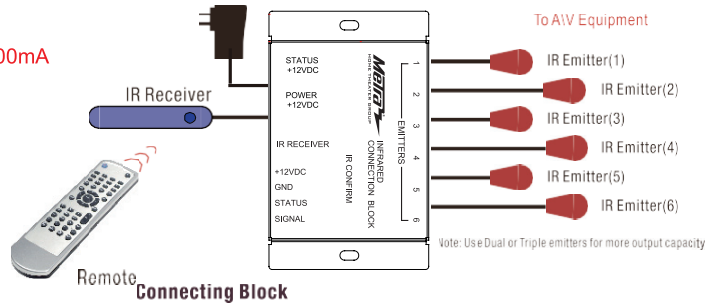

This is the common way to connect the IR receiver cable to IR connecting block.

Connection 2

Power adapter 12V 200mA

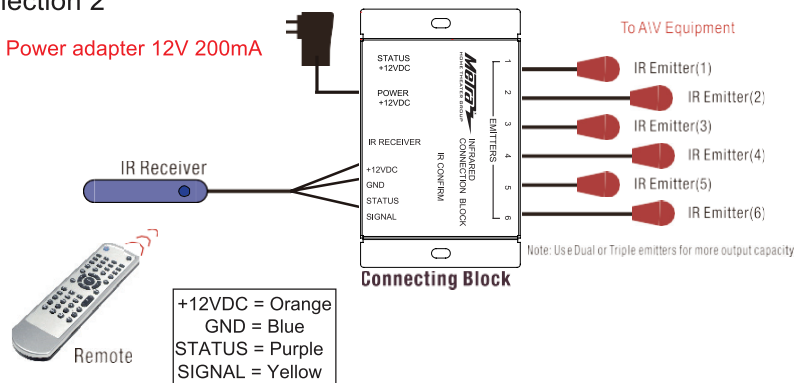

If you want to extend the length of IR receiver cable as per your installation requirement, you will need the 3.5mm stereo type mini plug removed to extend the wire run to the 3-terminal block. The MAX length of the IR receiver cable can reach 18 meters.

Note: Look at the connection diagram for the 3 wires carefully, the "STATUS" pin of the terminal block can't be wired. Plug the power adapter into "POWER" port.

Connection 3

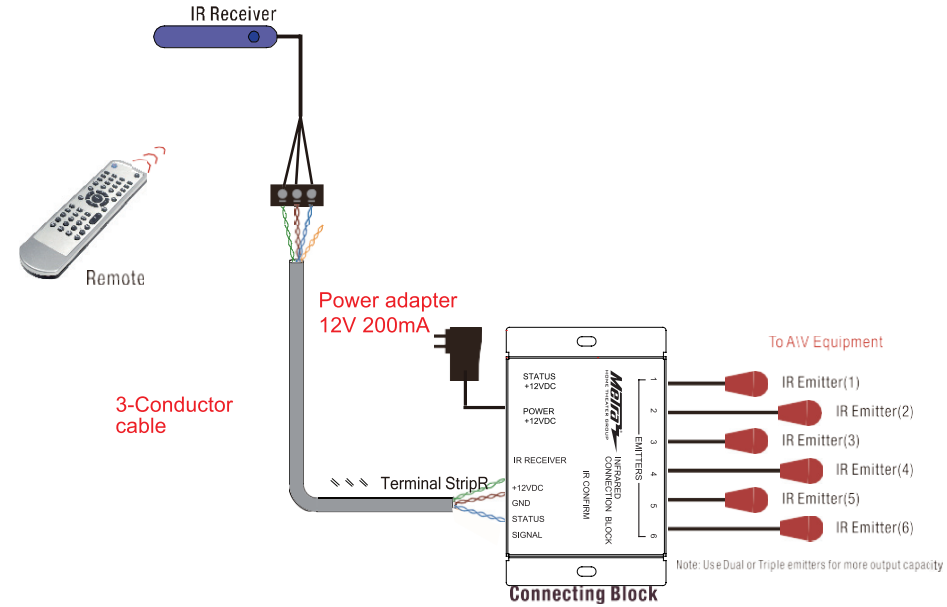

You can also use a 3-conductor inner-room cable to run the extension, 1pcs extra Terminal block is required (not supplied in package), the TOTAL extension length can reach 18 meters from connection block to IR receiver. Plug the power adapter into "POWER" port.

Connection 4

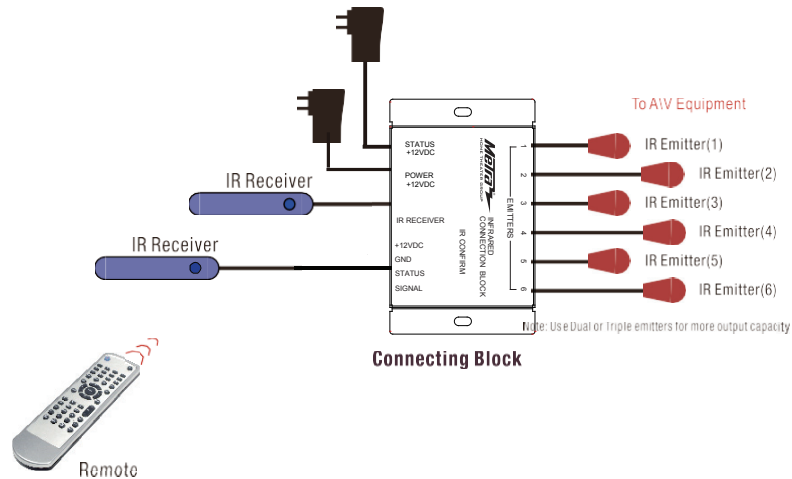

You are allowed to connect 2pcs IR receiver cables to the IR connecting block. Connect one IR receiver cable to “IR RECEIVER” port, connect the other IR receiver cable (with 3.5mm stereo plug removed) to the terminal block, you need two power adapters in order to make two IR receivers work together. One power adapter (12V 0.2A, 1pcs supplied in package) connected to “POWER” port, the other power adapter (12V 0.2A, not supplied in package) connected to “STATUS” port

Note: Look at the connection diagram for the 3 wires carefully, the “+12V DC” port of the terminal block can’t be wired.

4. Features

1. Control up to different 12 devices.
2. Send signals to 6 emitters. (Single, Dual)
3. Detachable IR Receiver input.
4. IR Confirmation LED.
5. Quick Mount.
6. Sleek IR receiver design.

5. Technical Data

IR connecting block

Feed POWER:	100-240VAC 50/60Hz 12V DC 200mA (supplied)
Feed STATUS:	12V DC 200mA (not supplied)
IR Receiver connection:	1x 1/8”(3.5mm Stereo Jack) input
IR Emitter connection:	6 x 3.5mm jack plug (mono)
Dimension:	3.25” x 1.85” x 1”
Weight:	6 oz

IR receiver built-on

Connection:	3.5mm jack plug
Receive Frequency range:	38 KHz to 58 KHz
Transmit Frequency range:	38 KHz & 56 KHz
Length of cable:	3 meters
Dimension:	2.7”x 0.46” x 0.48”
Weight:	20g

IR emitter

Connection:	3.5mm jack plug
Length of cable:	3 meters