

## • IMPORTANT SAFETY INSTRUCTIONS

1. Do not mix up the Transmitter and Receiver, and the IR blaster and IR receiver.
2. Do not plug-in/out the cables ,when it is in using.
3. Use DC 5V power supply only. Make sure the specification matched if using 3rd party DC adapters.
4. Support power from transmitter to receiver unit over the CAT6 cable.

## • INTRODUCTION

This HDMI extender splitter works with 4 HDMI CAT6 extender receivers to split and extend 1 HDMI source to 4 HDMI displays over single CAT6/6a/7 cable up to 40m/131ft. The highest resolution supported is 1920x1080@60Hz, and it supports IR passback, EDID pass through and only one power adapter for the transmitter is needed, the Receiver is powered by the transmitter over CAT6 cable. Ideal solution for HDMI exhibition, Video conference and show center, ect.

## • PACKAGE CONTENTS



Transmitter unit x1pcs



Receiver unit x4pcs



User Manual x1pcs



IR blaster extension cable x1pcs

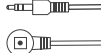

IR receiver extension cable x4pcs



DC5V/3A x1pcs

## • FEATURES

1. Distribute 1 HDMI source to 4 HDMI displays over network cable simultaneously.
2. Support one HDMI Loop-out.
3. Compatible with CAT6/6a/7 network cables.
4. The transmission distance is up to 40m/131ft.
5. The highest resolution supported is 1920x1080@60Hz.
6. Support 20~60Hz IR pass back.
7. Support EDID Setting function.
8. Support power from transmitter to receiver unit over the CAT6 cable.
9. Plug and play.
10. Wall-mounted function, easy installation.

## • INSTALLATION REQUIREMENTS

1. HDMI source device(computer graphics card, DVD,PS3, HD monitoring equipment etc).
2. HDMI display device like SDTV, HDTV, and projector with HDMI port.
3. UTP/STP CAT6/6A/7 cable, follow standard IEEE-568B.

## • PANEL DESCRIPTION

### 1. Transmitter unit (TX)

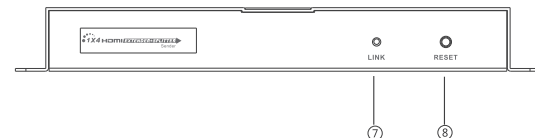
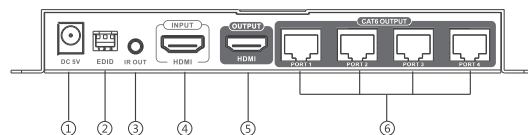

- |  |                           |
|--|---------------------------|
| ① Power input ( DC5V )                                     | ⑤ HDMI output             |
| ② EDID switch  | ⑥ RJ45 signal output      |
| ③ IR signal output to connect with blaster extension cable | ⑦ Power/ signal indicator |
| ④ HDMI input   | ⑧ Reset button            |

### 2. Receiver unit (RX)

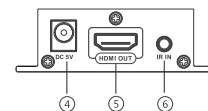
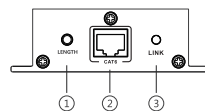

- |   |   |
|---|---|
| ① LENGTH: for adjusting to the length of network cable  | ④ DV5V power input (OPTIONAL)                                 |
| ② RJ45 signal input   | ⑤ HDMI signal output  |
| ③ RJ45 indicator led it lights on all the time with HDMI signal transmission, flashes with no signal transmission | ⑥ IR signal input to connect with IR receiver extension cable |

Remarks: The LENGTH key is designed for switching between automatic and manual setting to adjust cable length. Powered on without any operation, extender works with parameter set and memorized before. Powered on and then press LENGTH key, The first two press, it will entering automatic mode to adapt cable length. The following 12 times of pressing, it will entering manual mode in 12 levels to meet different cable length. After all 12 levels of press, it will entering auto mode again and into next loop.

## • Installation Procedures

### 1. How to make a CAT5/5E/6 network cable

Follow the standard of IEEE-568B:

- |                 |           |
|-----------------|-----------|
| 1- Orange/white | 2- Orange |
| 3- Green/white  | 4- Blue   |
| 5- Blue/white   | 6- Green  |
| 7- Brown/white  | 8- Brown  |



### 2. Connection

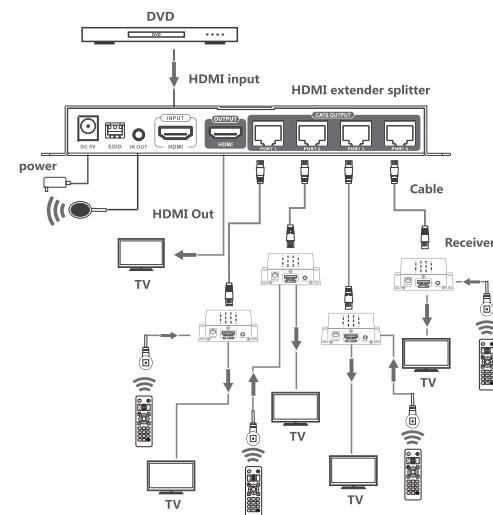

Remarks: Please do not remote control two or RX units' IR cable at the same time, which to avoid interference.

### 3. Connection instruction:

- 1) Connect the HDMI signal source device to the Transmitter HDMI input port with HDMI cable.
- 2) Connect IR blaster to EXTENDER IR OUT
- 3) Connect the Transmitter RJ45 port to HDMI EXTENDER RX's Rj45 input port by network cable.
- 4) Connect HDMI EXTENDER RX's HDMI output port to HDMI display's HDMI input port by HDMI cable and set the HDMI display's signal source to be HDMI port.
- 5) Supply the power(Power's signal light is red, when there are signal input then the power light is blue),the product will work.

### 4.EDID Setting

- 1) HDMI source device reads the EDID information of the transmitter (TX) and then output the relative HDMI signal format.
- 2) There are 8 build-in EDID status, and others could be selected by the EDID switch in the HDMI extender splitter(transmitter), the detail Setting Information shown as below:



Switch UP : use the Arabic numeral "1" to represent



Switch DOWN : use the Arabic numeral "0" to represent

SW1	SW2	SW3	EDID Mode
0	0	0	720P@50Hz 2.1CH
1	0	0	720P@50Hz 7.1CH
0	1	0	1080i@60Hz 2.1CH
1	1	0	1080i@60Hz 7.1CH
0	0	1	1080P@60 2.1CH
1	0	1	1080p@60Hz 7.1CH
0	1	1	Read Loop-out(if not connect the loop-out show default)
1	1	1	Default 720P@50Hz 2.1CH

### • FAQ

Q : No image or audio output on display ?

- A: 1) Please check whether display on standby mode;  
2) Please check whether display HDMI signal channel in accord with HDMI input port;  
3) Please check whether " LINK " LED on RX side keeps on, LED flash means RX does not receive signal from TX;  
4) Please check whether signal indicator LED on TX turns blue, LED on red means no input signal;  
5) Please check whether input resolution supported by this product.

Q : Image unstable ?

- A: 1) Press the "LENGTH" or "RESET" button on the transmitter to re-identify the signal;  
2) Please pull & plug CAT cable on corresponding port to reconnect.

Q : Only partial ports have output ?

- A : 1) Please check whether CAT cable or HDMI cable connected correctly;  
2) Press the "LENGTH" or "RESET" button on the transmitter to re-identify the signal;  
3) Please pull & plug CAT cable on corresponding port to reconnect.

### • SPECIFICATION

Items	Specifications
HDMI signal	HDMI1.3, Compatible with HDCP1.2
Input	1 x HDMI
Output	4 x RJ45
Support resolutions	480i@60Hz, 480p@60Hz, 576i@50Hz, 576p@50Hz, 720p@50/60Hz, 1080i@50/60Hz, 1080p@50/60Hz
Transmit distance	Full HD resolution 1080p@60Hz up to 40 meters via CAT6 cable
IR signal	Support 20~60kHz IR device

EDID	Support EDID setting function
Working temperature	0°C ~ 60°C
Power supply	DC5V/3A
Power Consumption	<15W
Dimension	TX: 190(L) x 95.9(W) x 23.9(H) mm    RX: 71.6×66.6×22.6mm
Color	Black

### Disclaimer

The product name and brand name may be registered trademark of related manufacturers.TM and ® may be omitted on the user manual. The pictures on the user manual are just for reference,and there may be some slight difference with the real products.

We reserve the rights to make changes without further notice to a product or system described herein to improve reliability, function or design.



## 1×4 HDMI Extender Splitter

CS-1X4HDSPLEXT

User manual

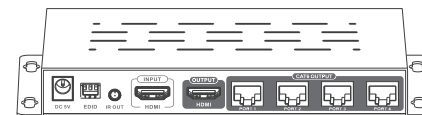

MetraHomeTheater.com  
866-839-9187

460 Walker Street  
Holly Hill, FL 32117-2653

©2017 Metra Electronics Corporation  
Designed and Manufactured to  
Metra Home Theater Group Specifications  
MADE IN CHINA